

FIAT

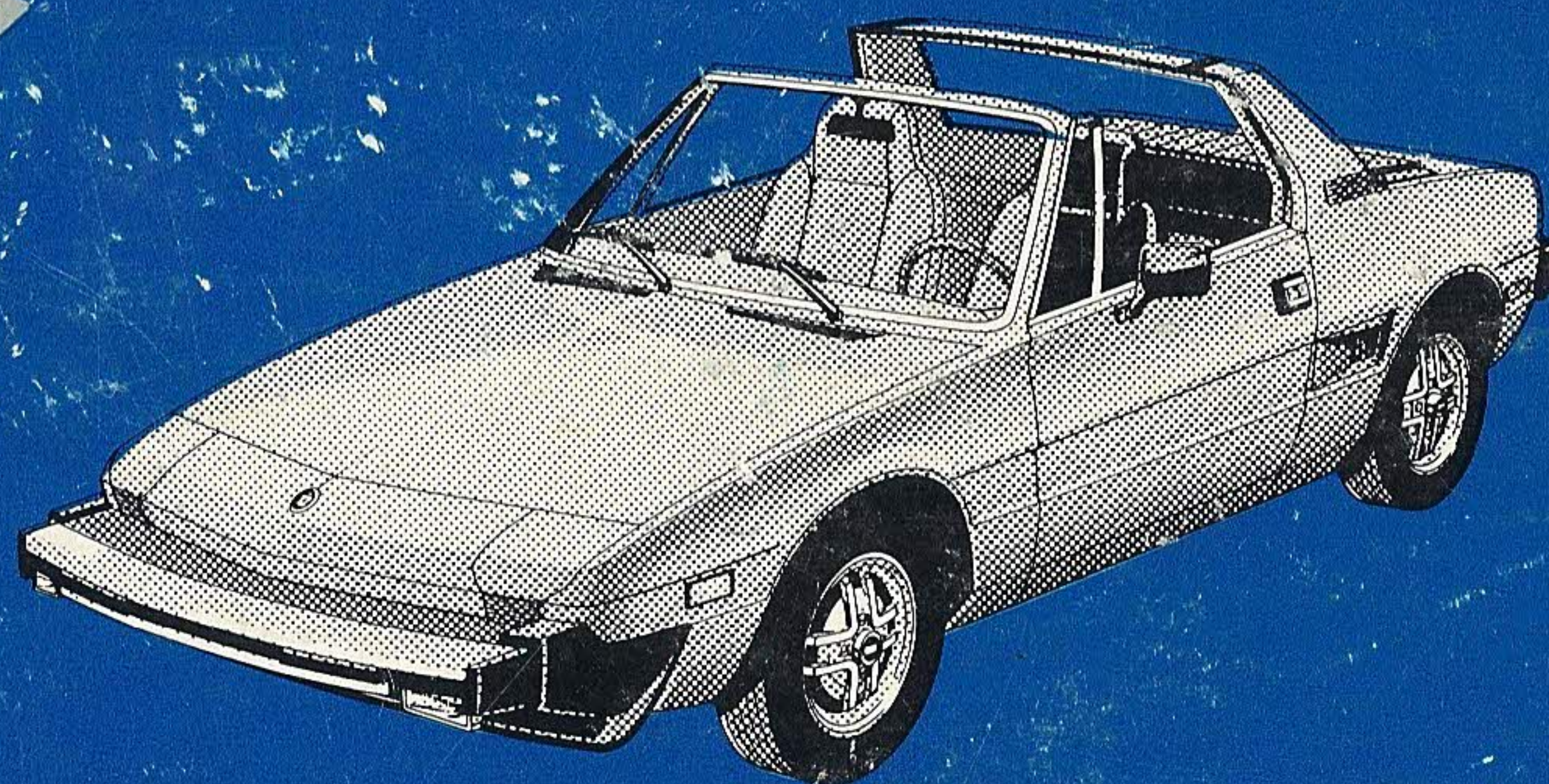
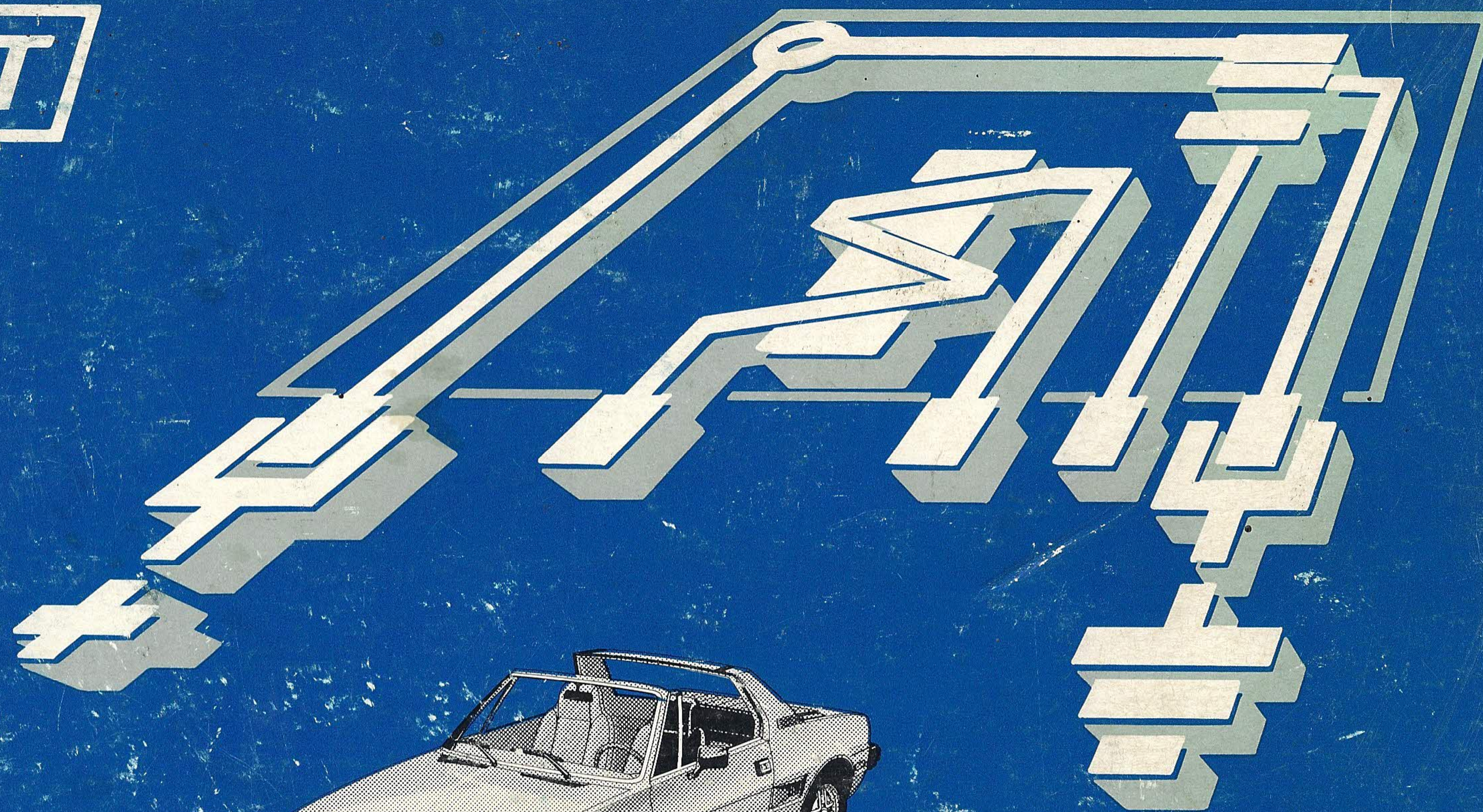

X1/9

ELECTRICAL DIAGNOSTIC MANUAL

1980-1981

CONTENTS

| | |
|----------------------------------|---|
| How To Use This Manual | 1 |
| Symbols | 2 |
| Electrical Troubleshooting | 4 |
| Fuse Data | 6 |
| Grounds | 7 |

INDEX

| | | | |
|---------------------------------|----|-------------------------------|----|
| Air Conditioner | 60 | —Front Marker | 32 |
| Carburetor Cooling Fan | 19 | —Front Park | 32 |
| Charge | 10 | —Hazard | 30 |
| Cigar Lighter | 46 | —Headlights | 26 |
| Clock | 42 | —Indicators | 42 |
| Coolant Fan | 18 | —Instrument Cluster | 40 |
| Coolant Temperature Gauge | 42 | —License | 34 |
| Fuel Gauge | 42 | —Lights-On Indicator | 34 |
| Fuel Injection | 20 | —Rear Marker | 34 |
| Fuel Injectors Fan | 22 | —Rear Park | 34 |
| Gauges | 42 | —Stop | 36 |
| Gulp Valve Bypass | 16 | —Tail | 34 |
| Headlight Cover Motors | 28 | —Turn | 30 |
| Heater | 58 | Power Antenna | 52 |
| Horns | 51 | Power Distribution | 10 |
| Idle Shut-Off | 13 | Power Windows | 54 |
| Ignition | 13 | Radio | 52 |
| Key Warning | 44 | Rear Window Defogger | 56 |
| Lights | | Remove Key Warning | 44 |
| —Back Up | 36 | Seatbelt Warning | 44 |
| —Brake Warning | 44 | Starter | 16 |
| —Courtesy | 38 | Tachometer | 42 |
| —Dash Panel | 40 | Windshield Wiper/Washer | 48 |

These electrical diagrams have been designed to make troubleshooting easier. Components which work together are shown together. For example, all electrical components used in the Starter circuit are shown on one simple diagram. The IGNITION SWITCH is shown at the top of the page. All wires, connectors, splices, switches, and motors are shown in the flow of current to ground at the bottom of the page. Notes are included which describe how switches and other components work. For example, on the Courtesy Lights diagram the DRIVER'S DOOR JAMB SWITCH includes this note: "closed with door open." Switches and sensors are usually shown in the "at rest" position, as if the engine were warm but the IGNITION SWITCH were "Off."

The Charge/Power Distribution diagram shows all connections from the BATTERY and GENERATOR to the IGNITION SWITCH, LIGHT SWITCH and fuses. If you combine the Charge/Power Distribution diagram with any other circuit diagram, you will have a complete picture of how that circuit gets its voltage and how it works. Ground diagrams show how several circuits are connected to common grounds.

The Circuit Operation description covers unusual features of each circuit. Circuit Operation also explains the flow of electricity through each circuit from voltage source to ground.

Read Troubleshooting for hints on how to find the cause of the problem and repair it. Read the "If" statements and find the one which describes the problem you are working on.

Component Location charts are included on the first page of Circuit Operation text for each circuit. Use the Component Location chart to find electrical components on the car. Each component is listed with a description of where to find it on the car, and a page/figure reference to a drawing.

General information is also included: 1) a list of electrical symbols and wiring connections; 2) instruction in Electrical Troubleshooting; 3) a Fuse block drawing, and 4) a table giving conversions from metric to American Wire Gage sizes.

Location References

References to LH, RH, front and rear are made from the driver's seat, looking forward.

| METRIC SIZE | AWG SIZE |
|-------------|----------|
| .8 | 18 |
| 1 | 16 |
| 1.5 | 14 |
| 2.5 | 12 |
| 4 | 10 |
| 6 | 8 |
| 10 | 6 |
| 32.0 | 2 |

Figure 1 — Wire Size Conversion Table

| WIRE COLOR ABBREVIATIONS | |
|--------------------------|------------|
| (Alphabetical Listing) | |
| BLK | BLACK |
| BRN | BROWN |
| DK BLU | DARK BLUE |
| GRN | GREEN |
| GRY | GRAY |
| LT BLU | LIGHT BLUE |
| ORN | ORANGE |
| PNK | PINK |
| RED | RED |
| VIO | VIOLET |
| WHT | WHITE |
| YEL | YELLOW |

SYMBOLS



COMPONENT SHOWN COMPLETE AND ONLY ONCE



COMPONENT SHOWN IN MORE THAN ONE PLACE OR PART OF A COMPONENT

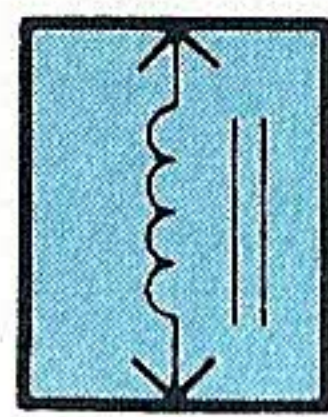

COLD START VALVE SUPPLIES ADDITIONAL FUEL FOR COLD STARTS

NAME OF COMPONENT

DETAILS ABOUT COMPONENT OR ITS OPERATION

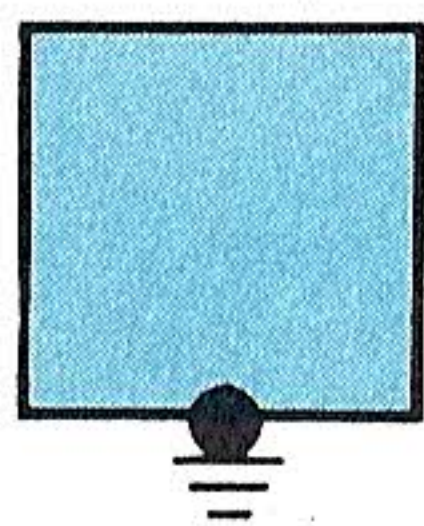

COMPONENT CASE IS DIRECTLY ATTACHED TO METAL PART OF CAR (GROUNDED)



WIRE IS ATTACHED TO METAL PART OF CAR (GROUNDED)

GROUND IS NUMBERED FOR REFERENCE ON COMPONENT LOCATION CHART

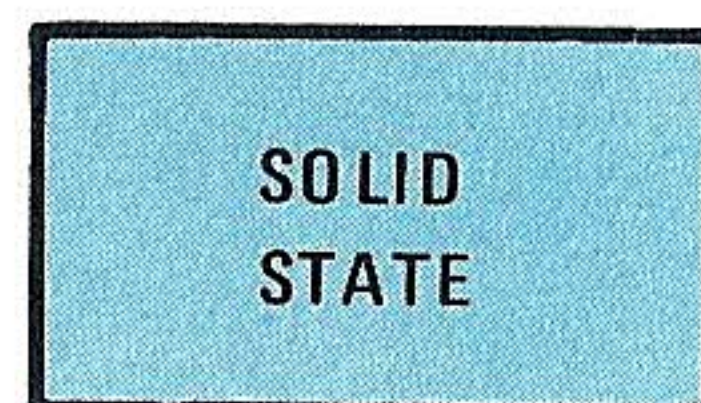

INCLUDES ONLY ELECTRONIC PARTS

CONNECTOR REFERENCE NUMBER FOR COMPONENT LOCATION CHART, CHART ALSO SHOWS TOTAL NUMBER OF PINS POSSIBLE. ALL CAVITIES MAY NOT BE USED. SEE EXAMPLES BELOW

.3 RED



SIZE - WIRE SIZE IS LABELED IN SQUARE MM (MILLIMETERS)
 COLOR - INSULATION COLOR IS SHOWN AND LABELED
 SPLICE - A SPLICE SHOWS THE CONNECTION OF TWO OR MORE WIRES

IF NO WIRE SIZE IS LABELED REPLACE WITH MATCHING WIRE SIZE



A BREAK IN WIRE IS SHOWN BY A WAVY LINE WIRE INSULATION IS ONE COLOR

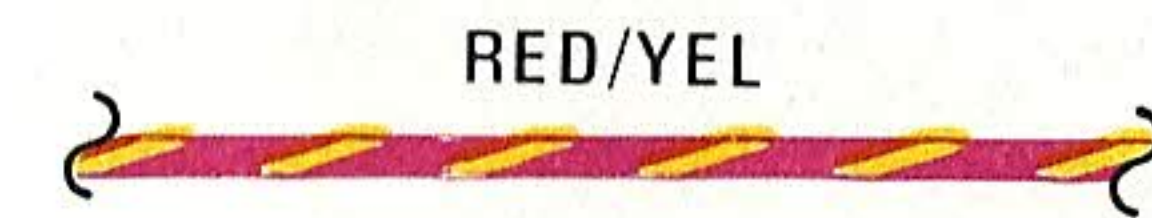

WIRE INSULATION IS ONE COLOR WITH ANOTHER COLOR STRIPE (RED WITH YELLOW)

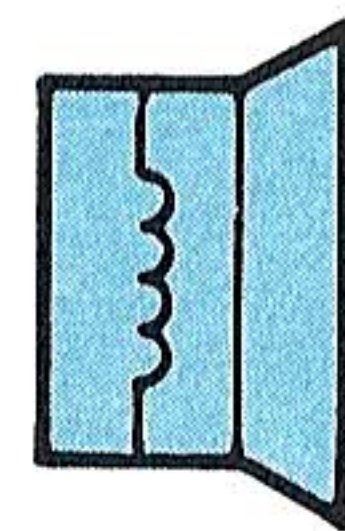

RADIO SPEAKER



HORN



COMPONENT CONNECTOR ATTACHED TO WIRE (PIGTAIL)

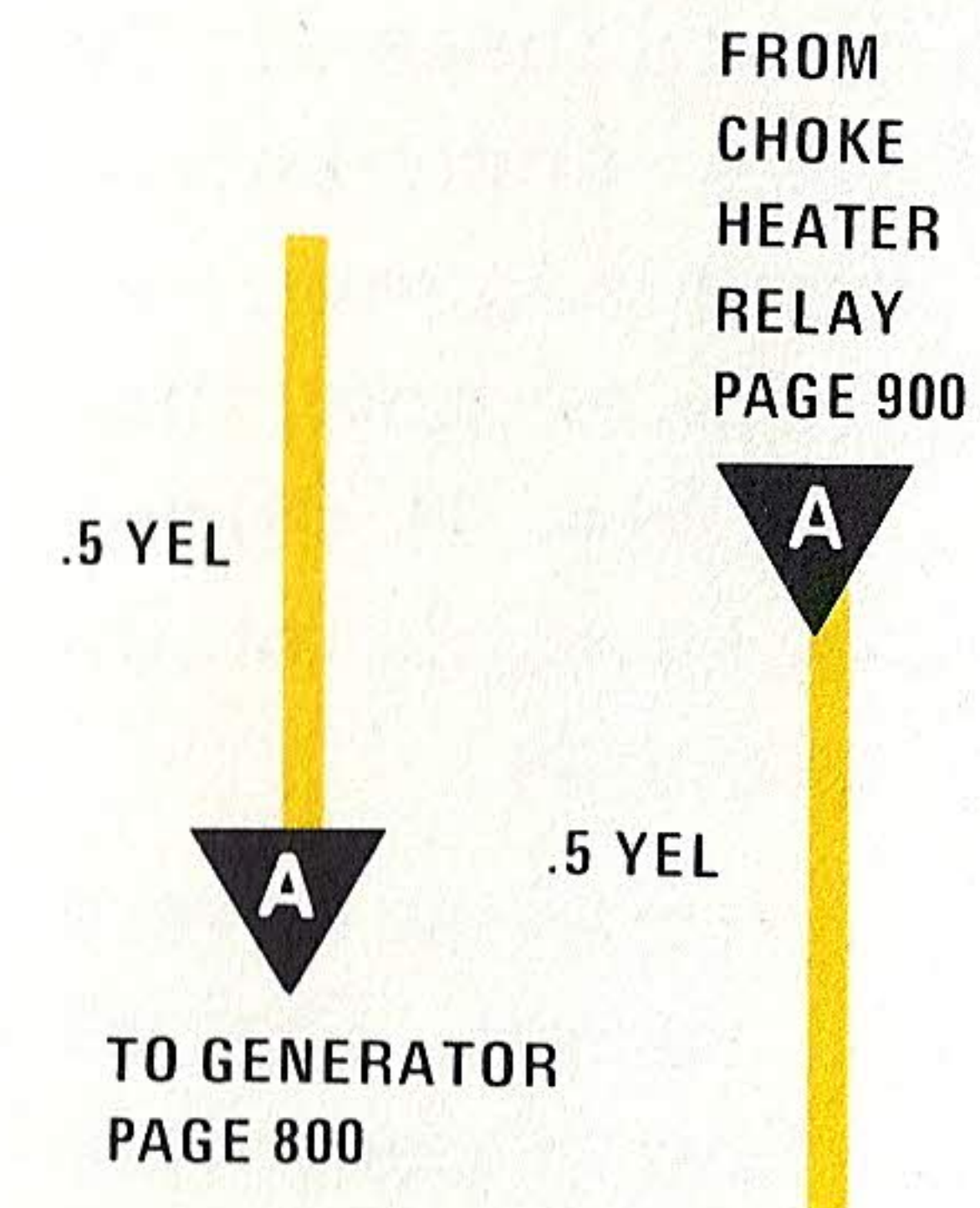

TWO ENDS OF ONE WIRE SHOWN IN TWO DIFFERENT PLACES. ARROW SHOWS POINT OF BREAK AND DIRECTION OF CURRENT FLOW



A WIRE WHICH CONNECTS TO ANOTHER CIRCUIT

LIGHTS: TURN/HAZARD/STOP/FRONT PARK/FRONT MARKER



ONE POLE,
TWO POSITION
SWITCH

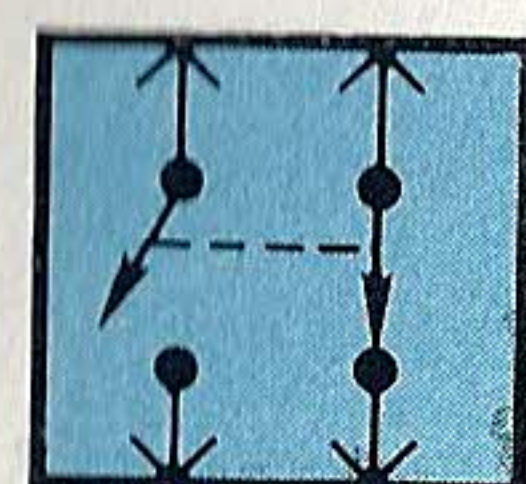

SWITCHES THAT
MOVE TOGETHER

DASHED LINE SHOWS
AN OPERATIONAL
CONNECTION
BETWEEN PARTS

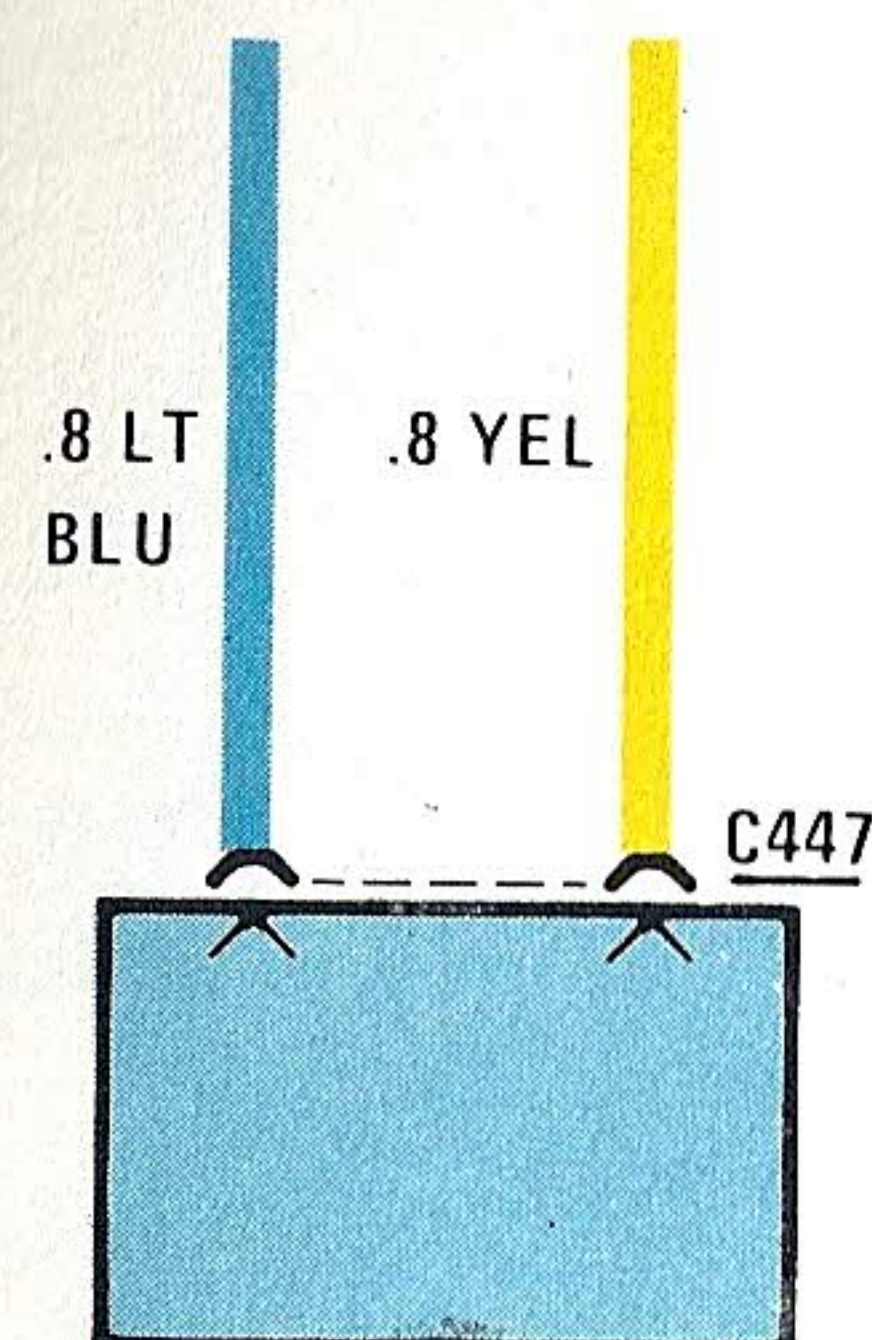

TWO CONNECTOR
CAVITIES IN THE
SAME CONNECTOR

DASHED LINE SHOWS
A PHYSICAL
CONNECTION
BETWEEN PARTS

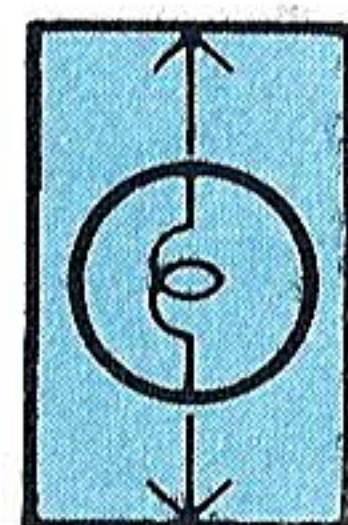

"EXHAUST GAS"
SENSOR INDICATOR
DISPLAYS THE
LIGHTED WORDS
"EXHAUST GAS"



CONNECTOR
ATTACHED TO
COMPONENT

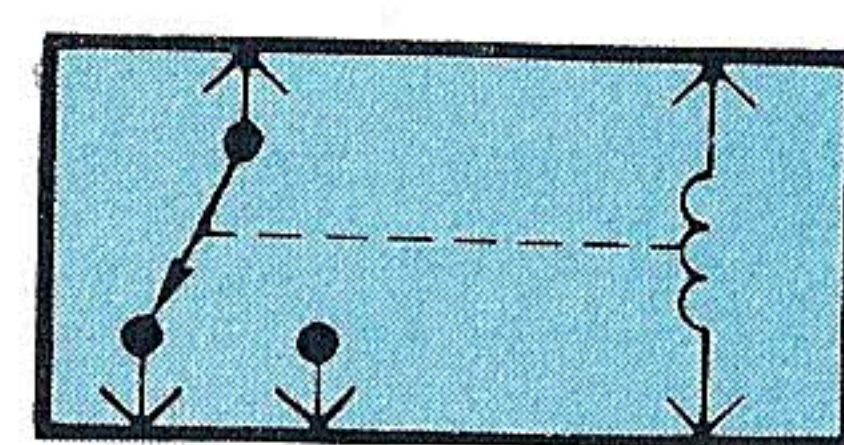

AT-REST
POSITION ACTIVATED
POSITION

RELAY SHOWN
WITH NO
CURRENT
FLOWING
THROUGH
COIL

WHEN CURRENT FLOWS
THROUGH COIL, CONTACT
MOVES FROM AT-REST TO
ACTIVATED POSITION

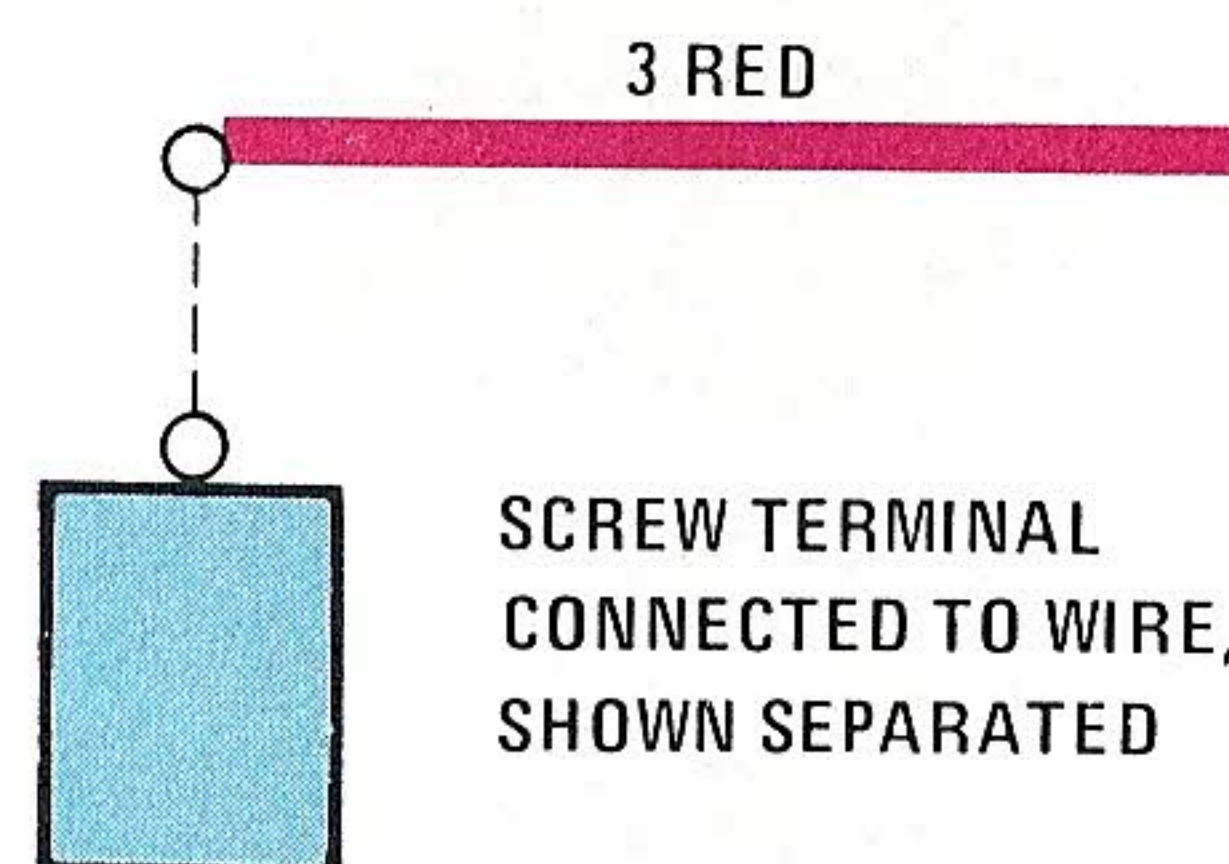

SCREW TERMINAL
CONNECTED TO WIRE,
SHOWN SEPARATED

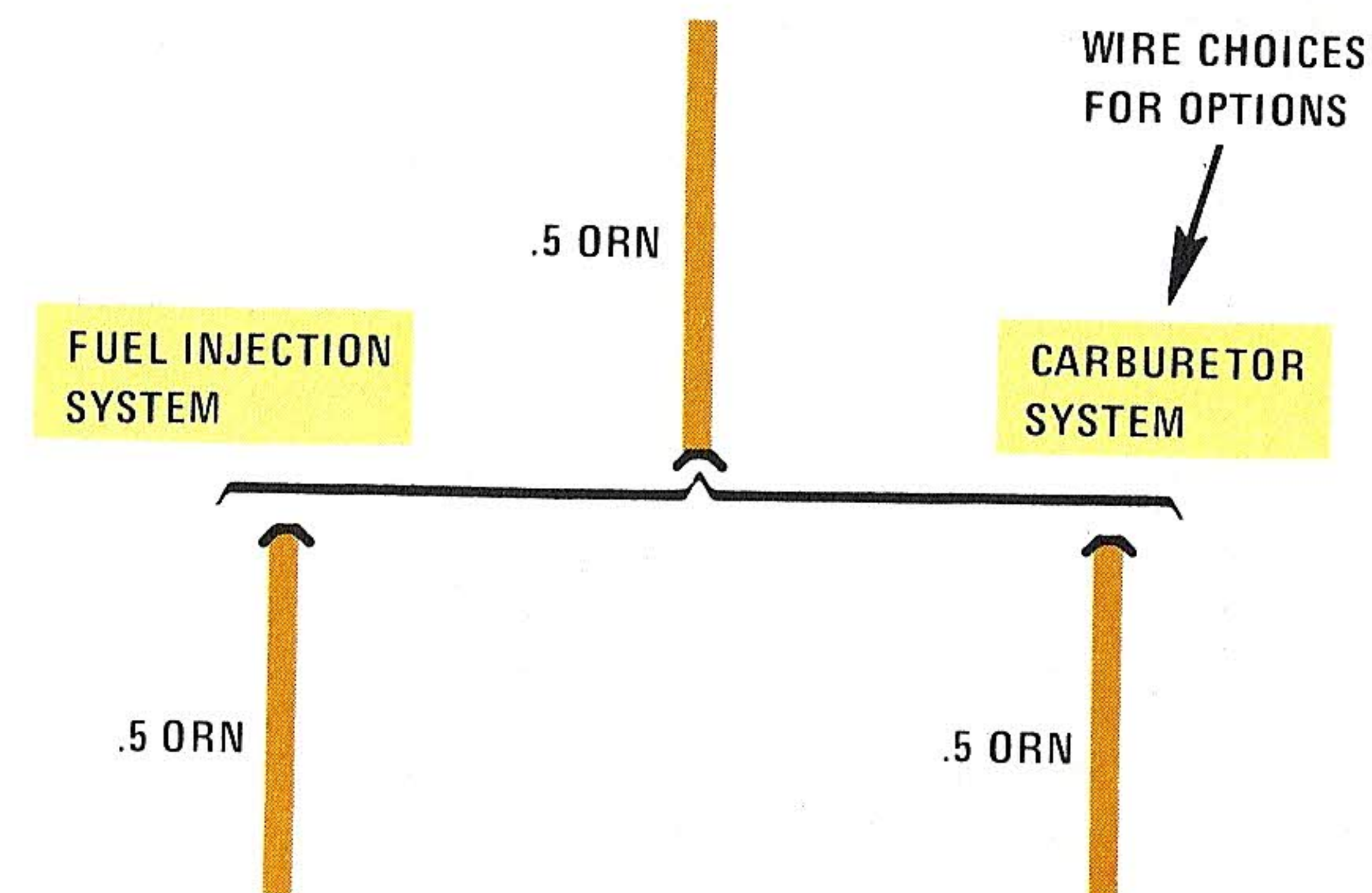

WIRE CHOICES
FOR OPTIONS



SINGLE
FILAMENT
BULB



DOUBLE
FILAMENT
BULB



RESISTOR



DIODE
CURRENT CAN
FLOW ONLY IN
THE DIRECTION
OF THE ARROW

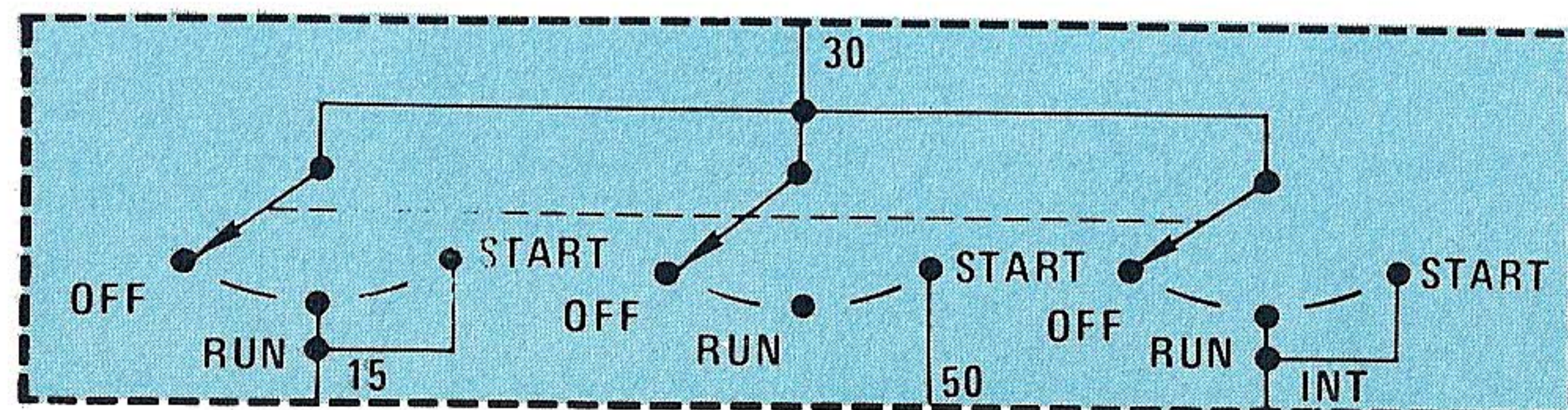

THREE POLE,
THREE POSITION SWITCH

DASHED LINE SHOWS
OPERATIONAL CONNECTION
BETWEEN PARTS

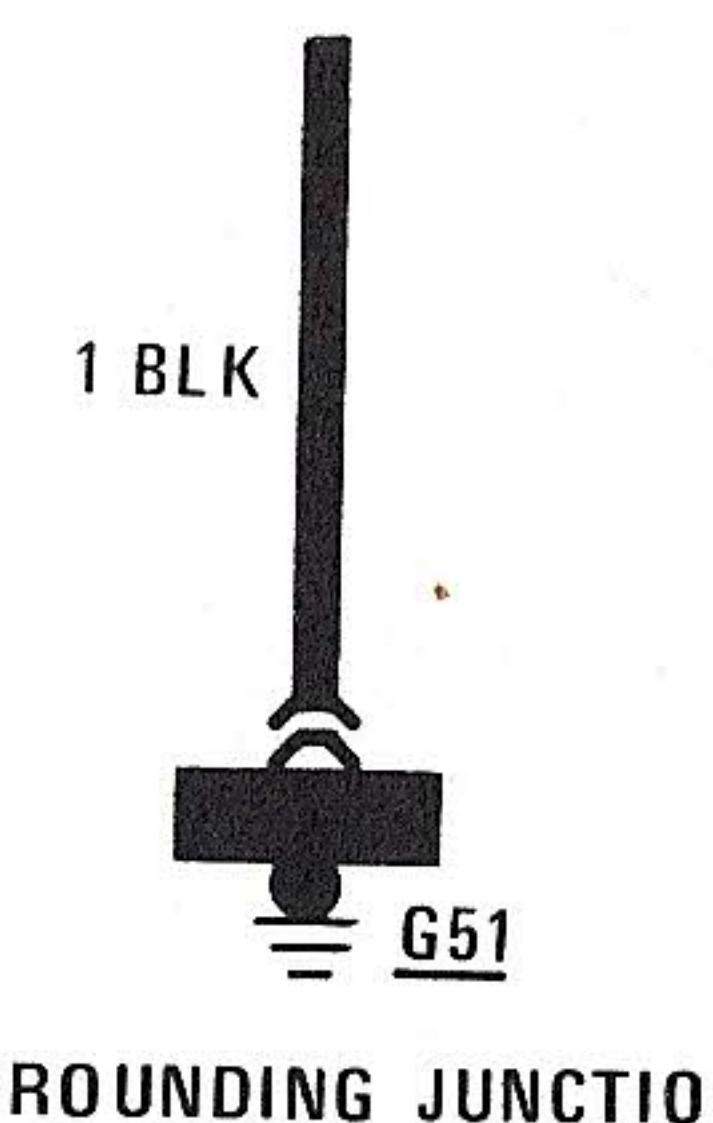

GROUNDING JUNCTION

ELECTRICAL TROUBLESHOOTING

TROUBLESHOOTING PROCEDURE

1. Check the Problem

Operate the problem circuit yourself to be sure you understand what's wrong. Don't waste time fixing part of the problem!

2. Read the Electrical Diagram

Study the diagram to understand how the circuit should work. Read the detailed description.

3. Find the Cause and Repair It

Use the Troubleshooting section with each circuit.

4. Test the Repair

Operate the repaired circuit in all ways to be sure you have fixed the whole problem.

TROUBLESHOOTING TOOLS

The troubleshooting procedures described here require the use of common electrical test equipment.

Test Light: A 12-volt bulb with a set of test leads.

Used for voltage check, short check.

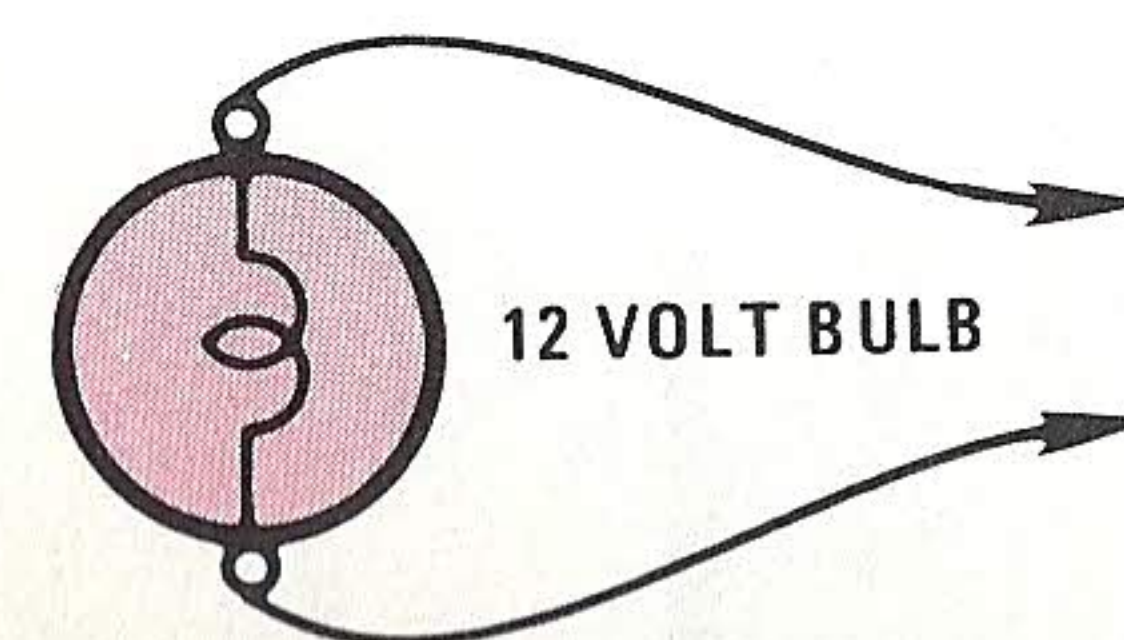

Test Light

Self-Powered Test Light: a bulb, battery, and set of test leads wired in series.

Used for continuity check, ground check.

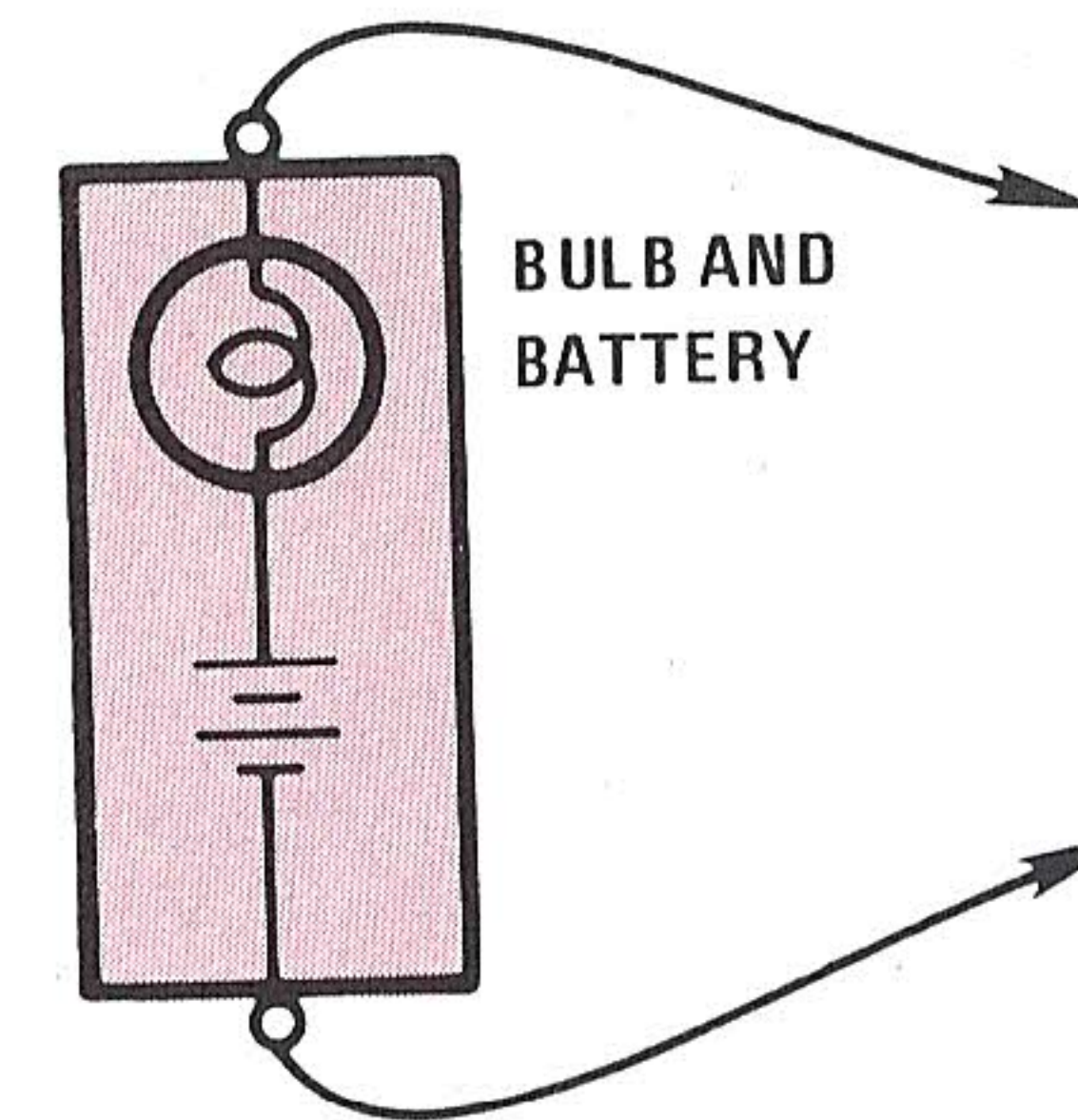

Self-Powered Test Light

Jumper Wire: a fuse holder with a set of test leads.

Used for bypassing open circuits.

CAUTION: Never use a jumper wire across any load (motors, etc.). This direct battery short may cause personal injury or fire.

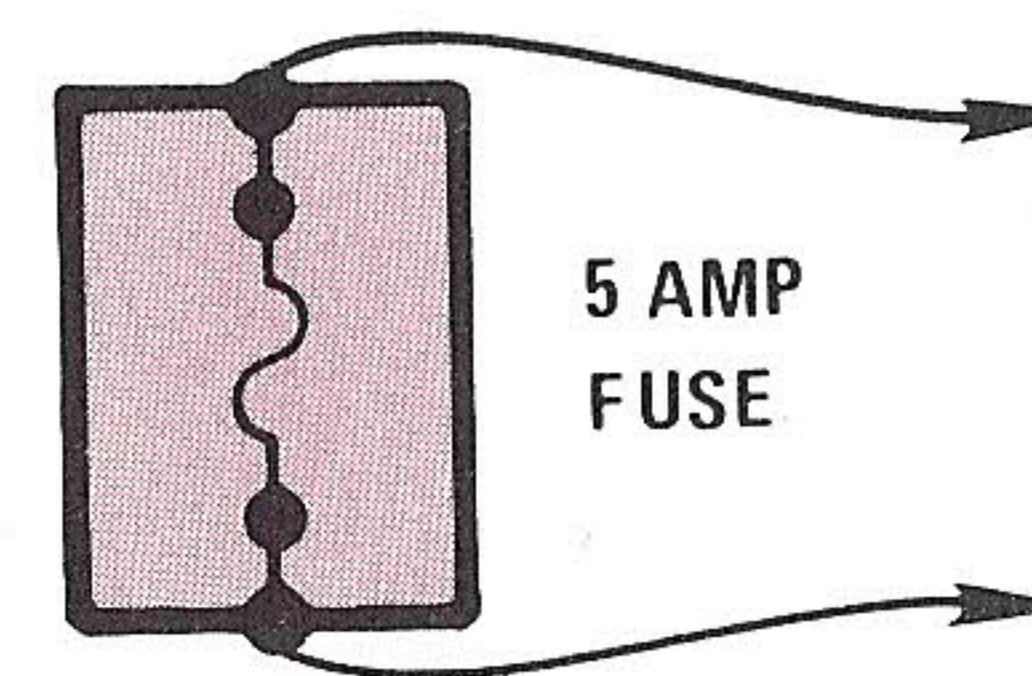

Jumper Wire

VOLTAGE CHECK

1. Connect one lead of Test Light to a known good ground or negative (-) battery terminal.
2. Connect other lead of Test Light to connector or terminal.
3. If bulb goes on, there is voltage present.

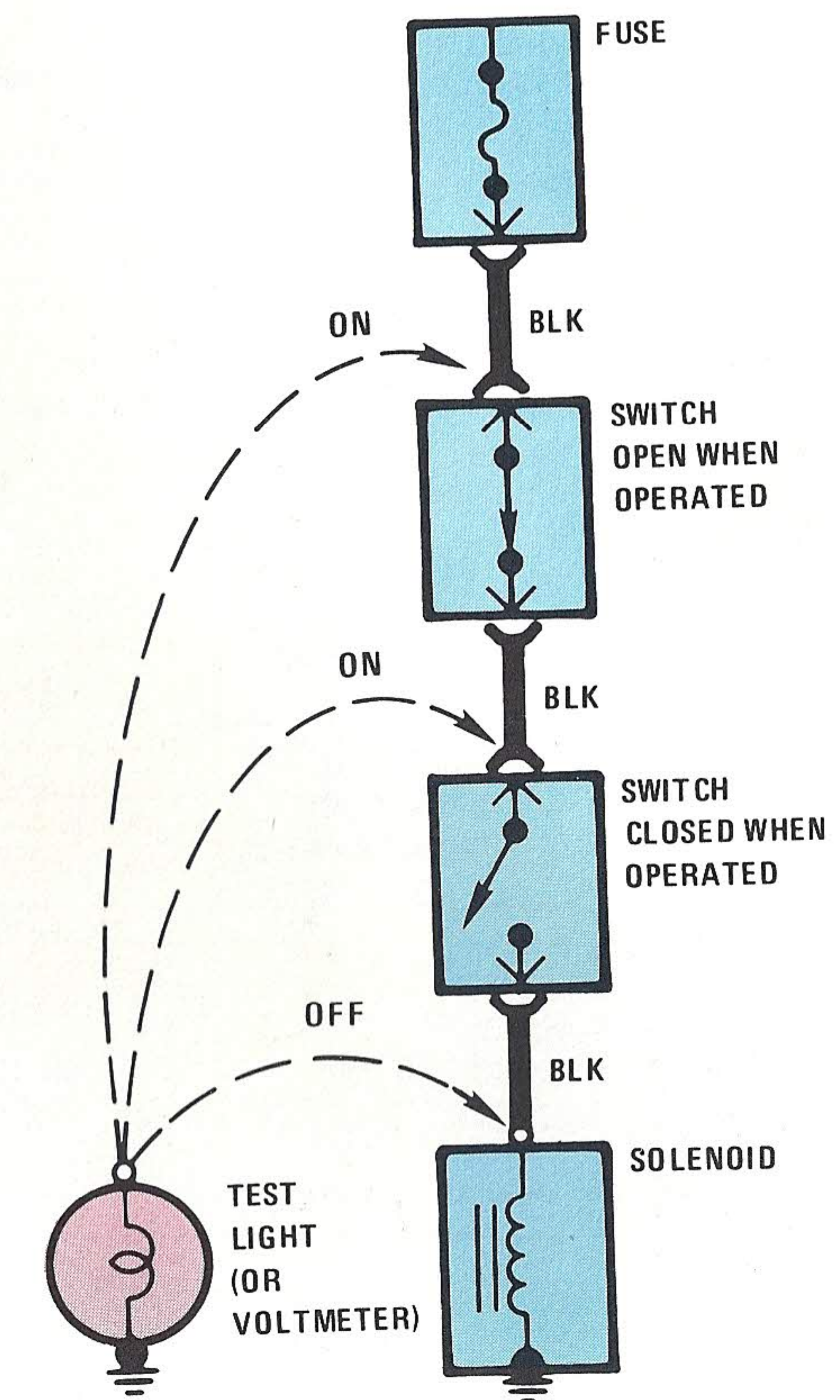

Voltage Check

FINDING A SHORT

1. Remove blown fuse and disconnect load.
2. Connect Test Light across fuse terminals.
3. Beginning near the fuse block, move the harness from side to side while watching the Test Light.
4. If bulb goes on, there is a short to ground in the wiring. Somewhere in that area the wire insulation has worn away and the circuit is grounding.

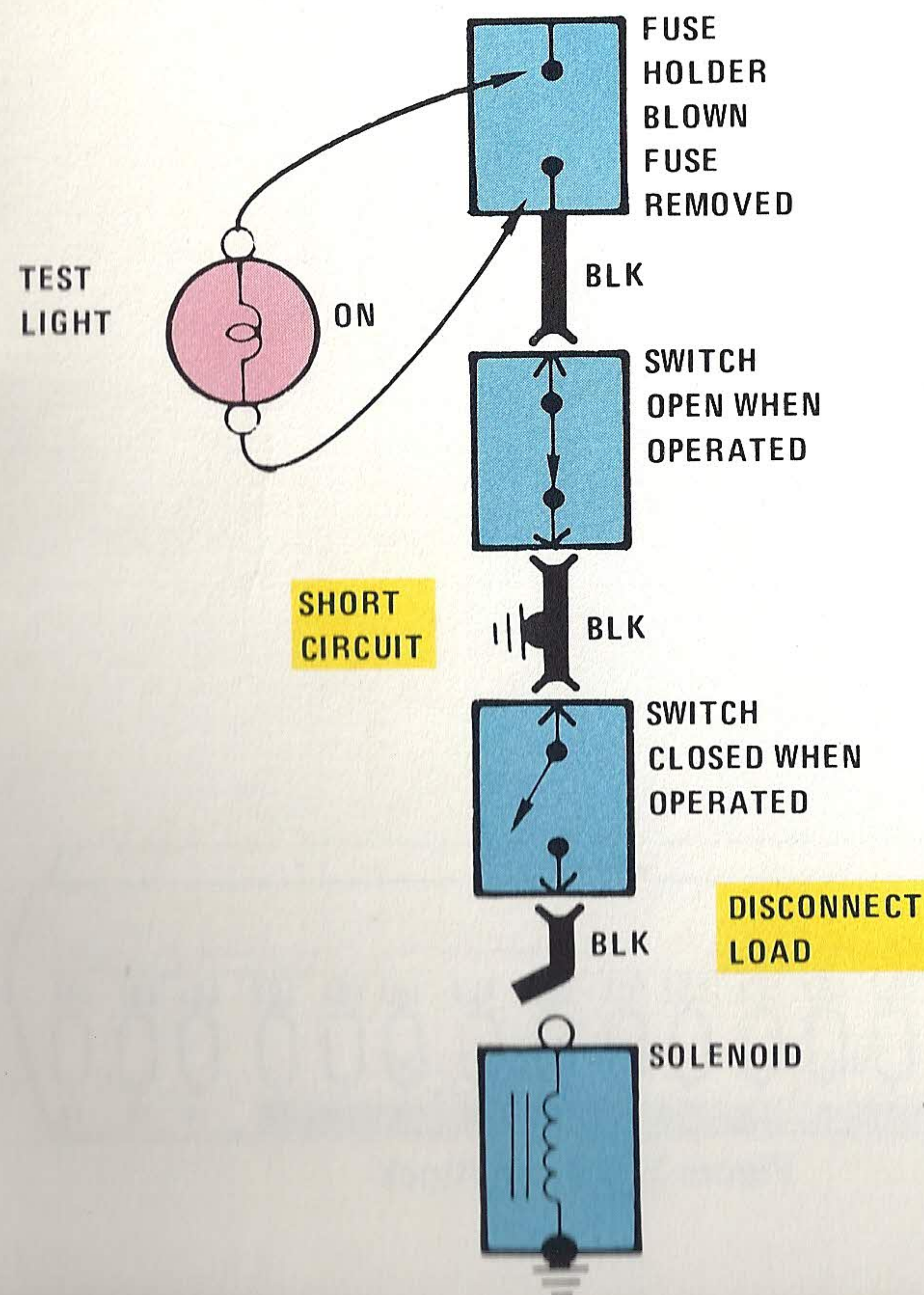

Finding a Short

CONTINUITY CHECK

NOTICE: Be sure no voltage is present in circuit during this test to avoid over-current and damage to parts.

1. Connect one lead of Self-Powered Test Light to one end of the circuit, and the other lead to the other end.
2. If bulb goes on, there is continuity. Switches can be checked the same way.

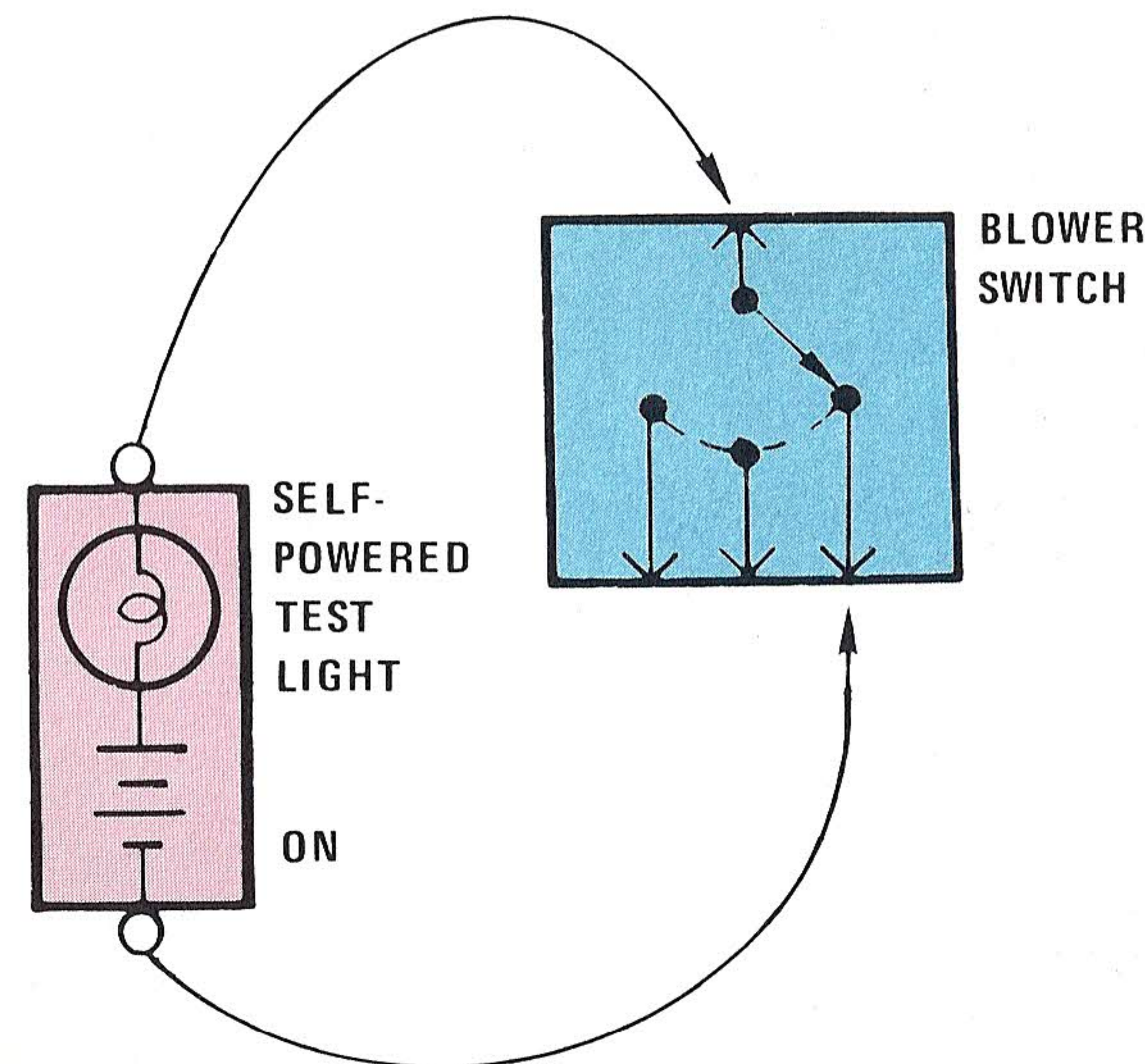

Continuity Check

GROUND CHECK

NOTICE: Be sure no voltage is present in circuit during this test to avoid over-current and damage to parts.

1. Connect one lead of Self-Powered Test Light to a known good ground, and the other lead to the wire in question.
2. If bulb goes on, there is a good ground.
3. If bulb stays off, there is no ground.

GENERAL TROUBLESHOOTING HINTS

If several circuits fail at the same time, chances are the power (fuse) or ground circuit is faulty.

Use the Fuse Block and Charging System/Power Distribution information to find out which circuits are powered through each fuse.

Use the Ground Distribution diagrams to find out which circuits have a common ground. Many car electrical problems are grounding faults.

PROTECTED CIRCUITS

Fuse A (8-Amps)

Stop lights
 Stop light switch
 A/C blower relay coil
 A/C control relay coil
 Heater fan motor
 Heater fan switch
 Instrument cluster lights
 Dash panel lights
 Turn lights
 Turn indicator
 Hazard indicator
 Rear window defogger switch
 Rear window defogger relay coil

Fuse B (8-Amps)

Windshield wiper/washer switch
 Windshield washer pump
 Wiper motor
 Back up switch
 Back up light
 Gulp valve thermostitch
 Gulp valve electrovalve solenoid
 Seatbelt timer
 Seatbelt relay coil
 Fasten seatbelt indicator
 Brake indicator
 Digital clock (display on)
 Oil pressure warning indicator
 Exh. gas sensor indicator

Fuse C (8-Amps)

LH hi beam headlight
 Hi beam indicator

Fuse D (8-Amps)

RH hi beam headlight

Fuse E (8-Amps)

LH dual beam headlight

Fuse F (16-Amps)

RH dual beam headlight

Fuse G (8-Amps)

LH front marker light
 LH front park light
 RH tail light
 LH license light
 RH rear marker light
 Lights-on indicator

Fuse H (8-Amps)

RH front marker light
 RH front park light
 LH tail light
 RH license light
 LH rear marker light
 Lights-on indicator
 Digital clock

Fuse I (16-Amps)

RH headlight motor

Fuse L (16-Amps)

LH headlight motor

Fuse M (16-Amps)

Rear window defogger
 Turn/hazard flasher

Fuse N (16-Amps)

Coolant fan
 Horns

Fuse O (16-Amps)

Condenser fan motor

Fuse P (16-Amps)

A/C blower motor

Fuse Q (3-Amps)

RH and LH headlight motor
 relay coils (down)

Fuse R (6-Amps)

RH and LH headlight motor
 relay coils (up)

Power Window In-Line Fuse

LH and RH power window motors

In-Line Fuse (8-Amps)

Fuel injectors fan motor
 Carburetor fan motor
 Seatbelt chime
 Cigar lighter
 Power antenna motor
 Digital clock (power)
 Courtesy light

Fuel Injection In-Line Fuse (16-Amps)

Auxiliary air regulator
 Fuel pump

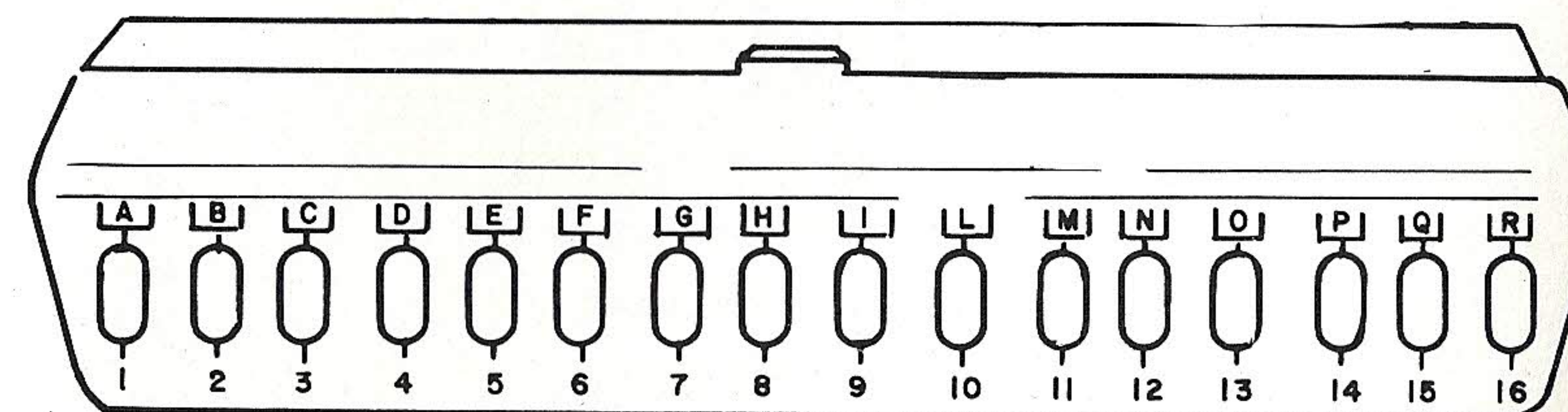
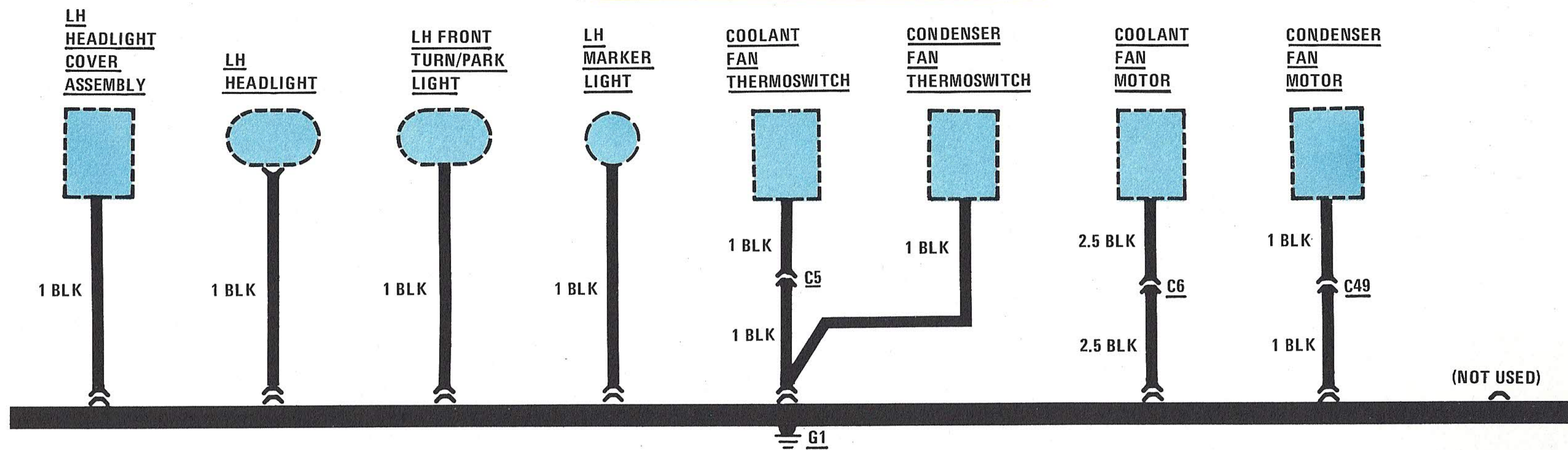
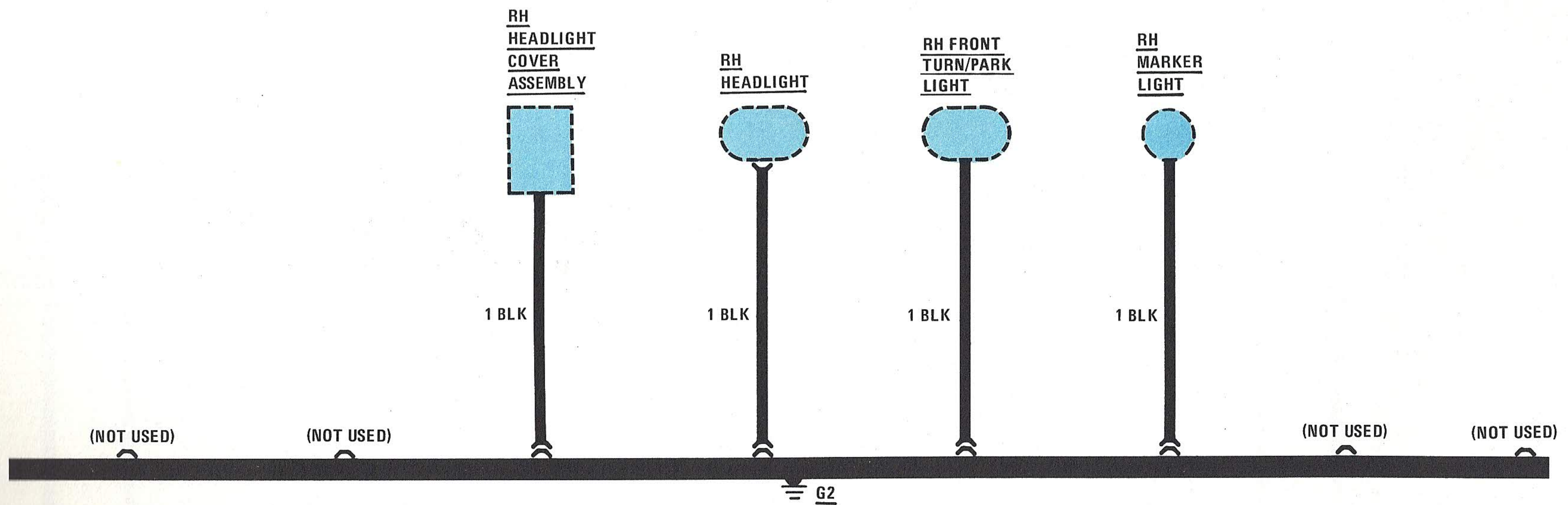

Figure 1 — Fuse Block

LH GROUNDING JUNCTION (G1)



RH GROUNDING JUNCTION (G2)



DASH PANEL GROUNDING JUNCTION (G3)

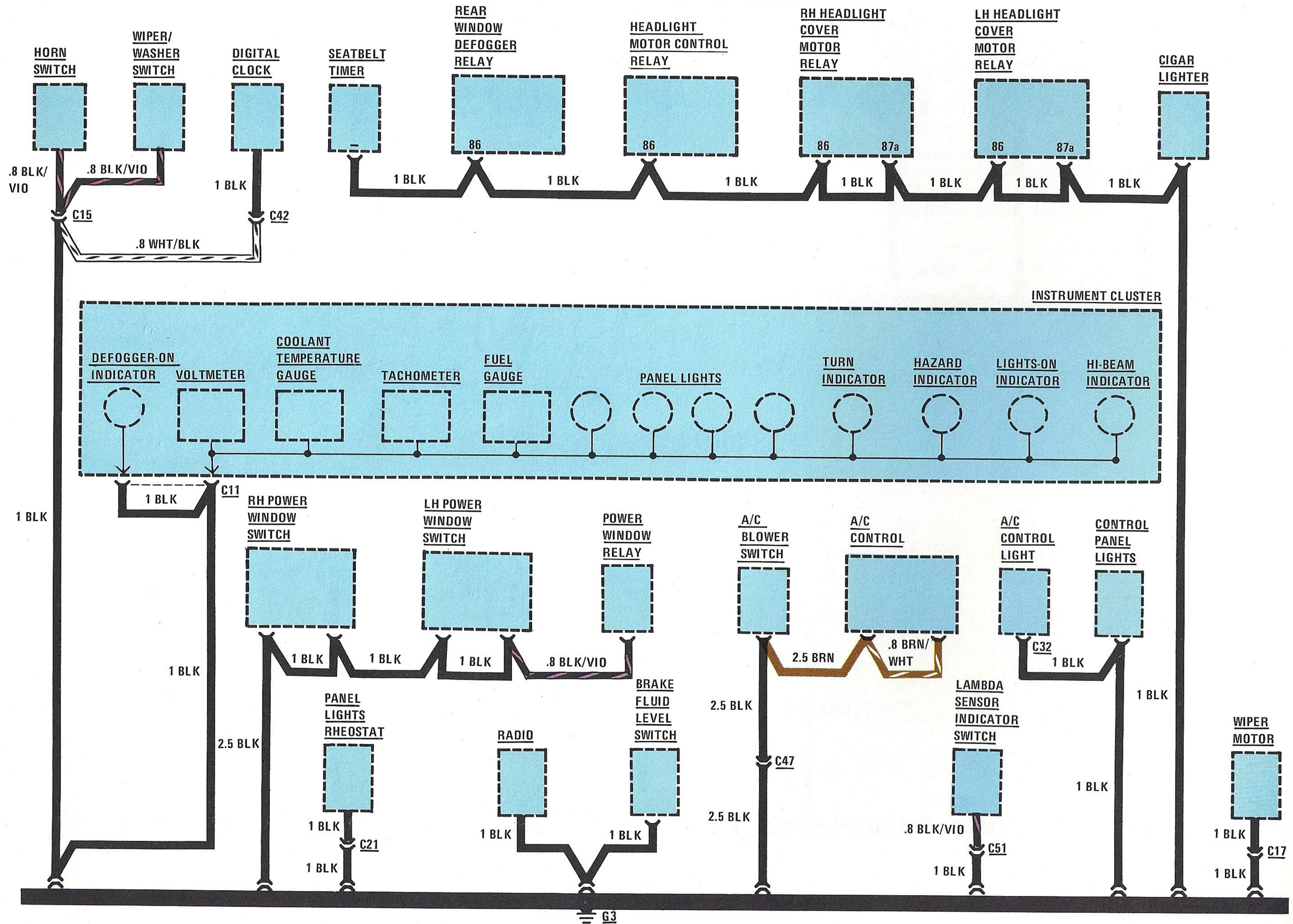

BODY GROUNDING JUNCTION (G5)

FUEL INJECTION SYSTEM

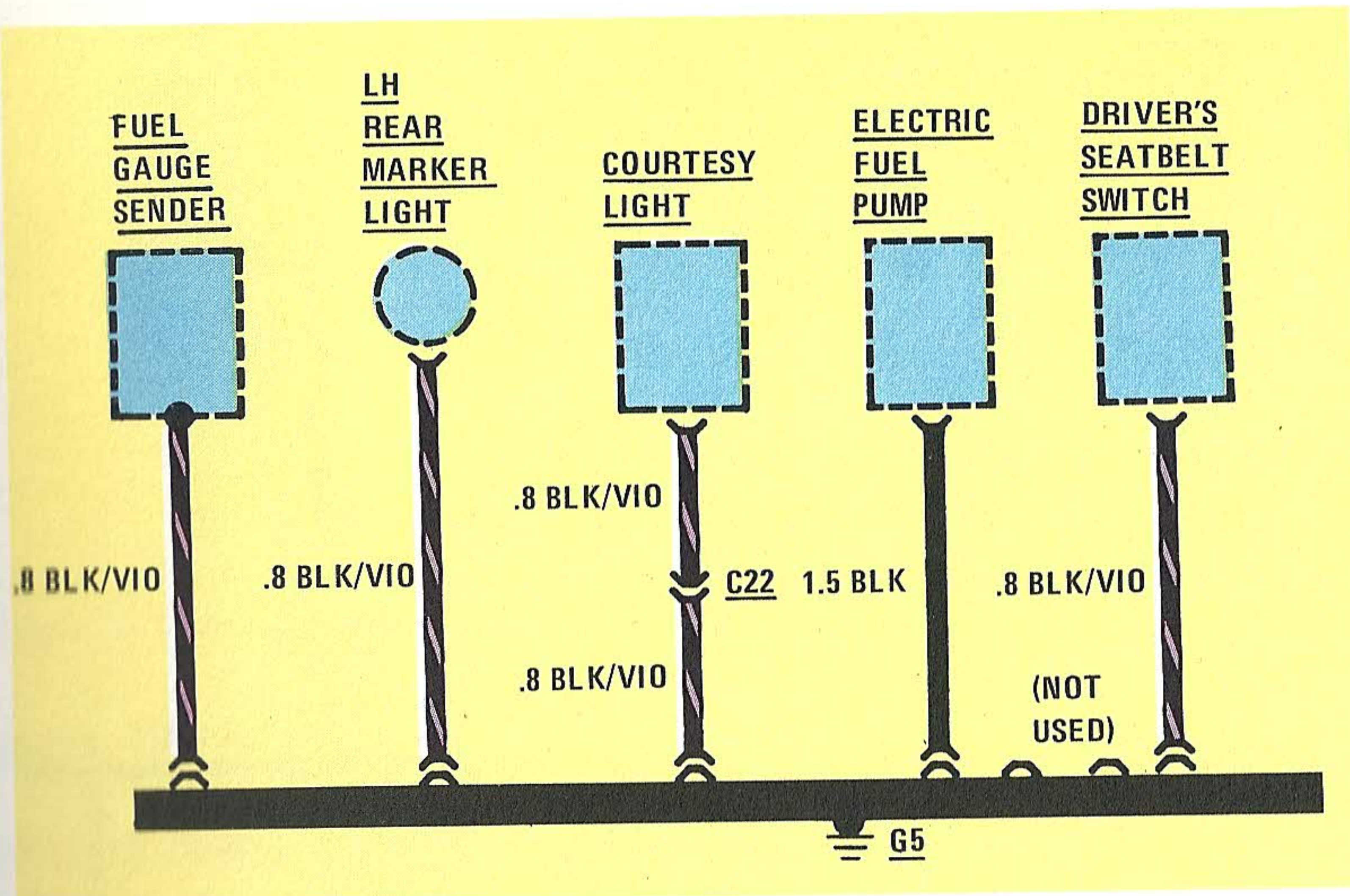

CARBURETOR SYSTEM

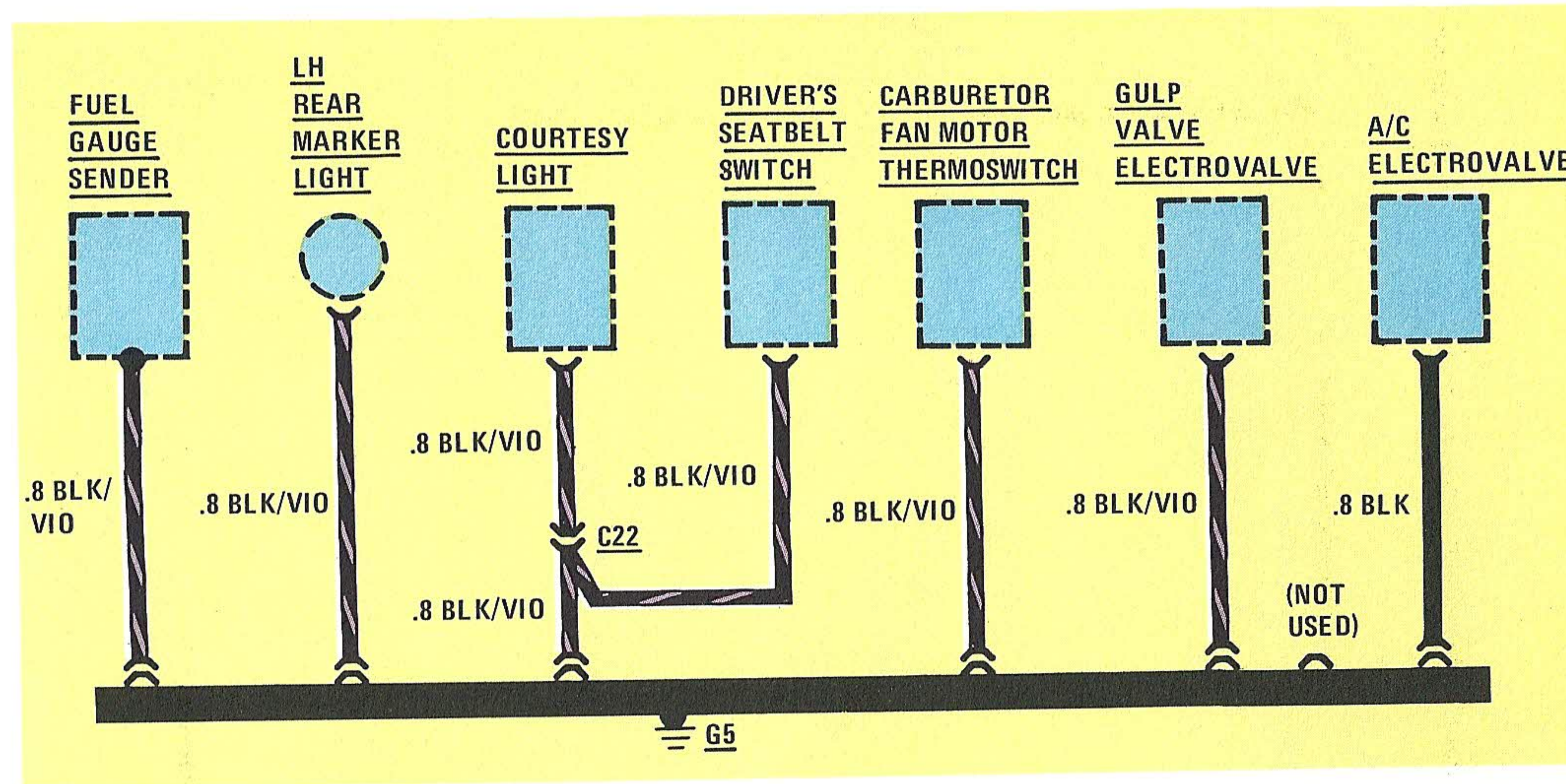

REAR LIGHTS GROUNDS (G8, G7)

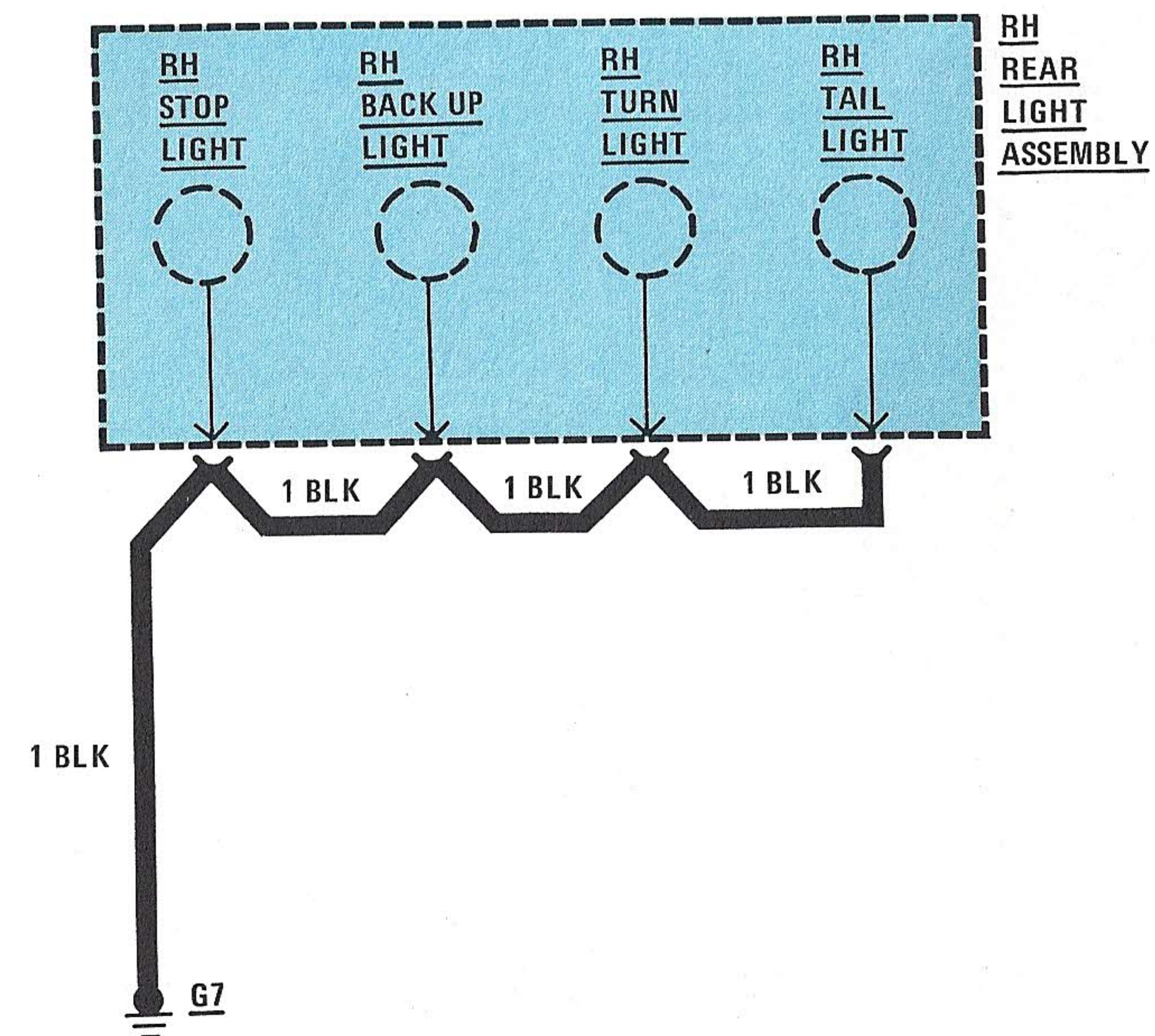
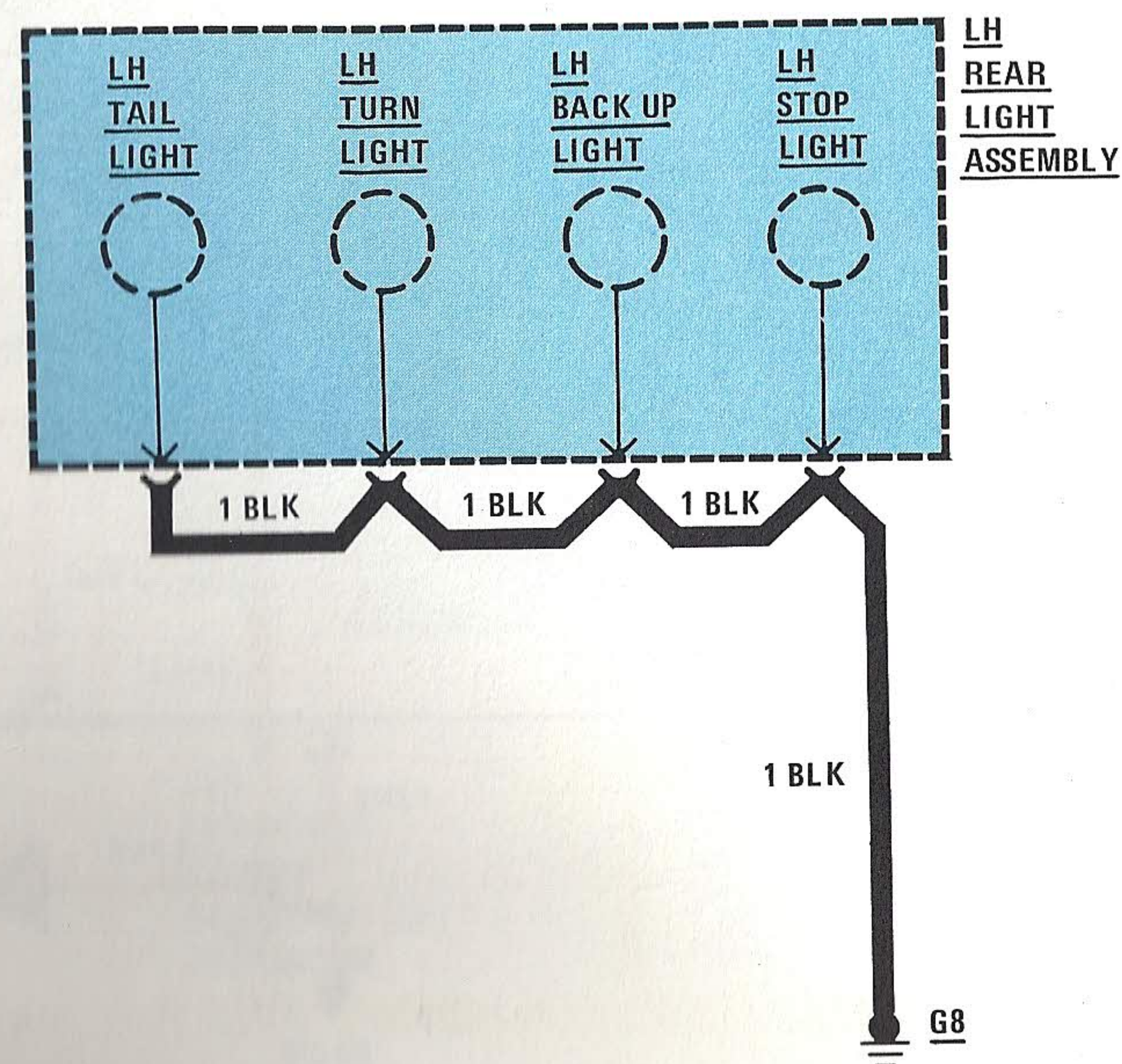

CHANGE/POWER DISTRIBUTION

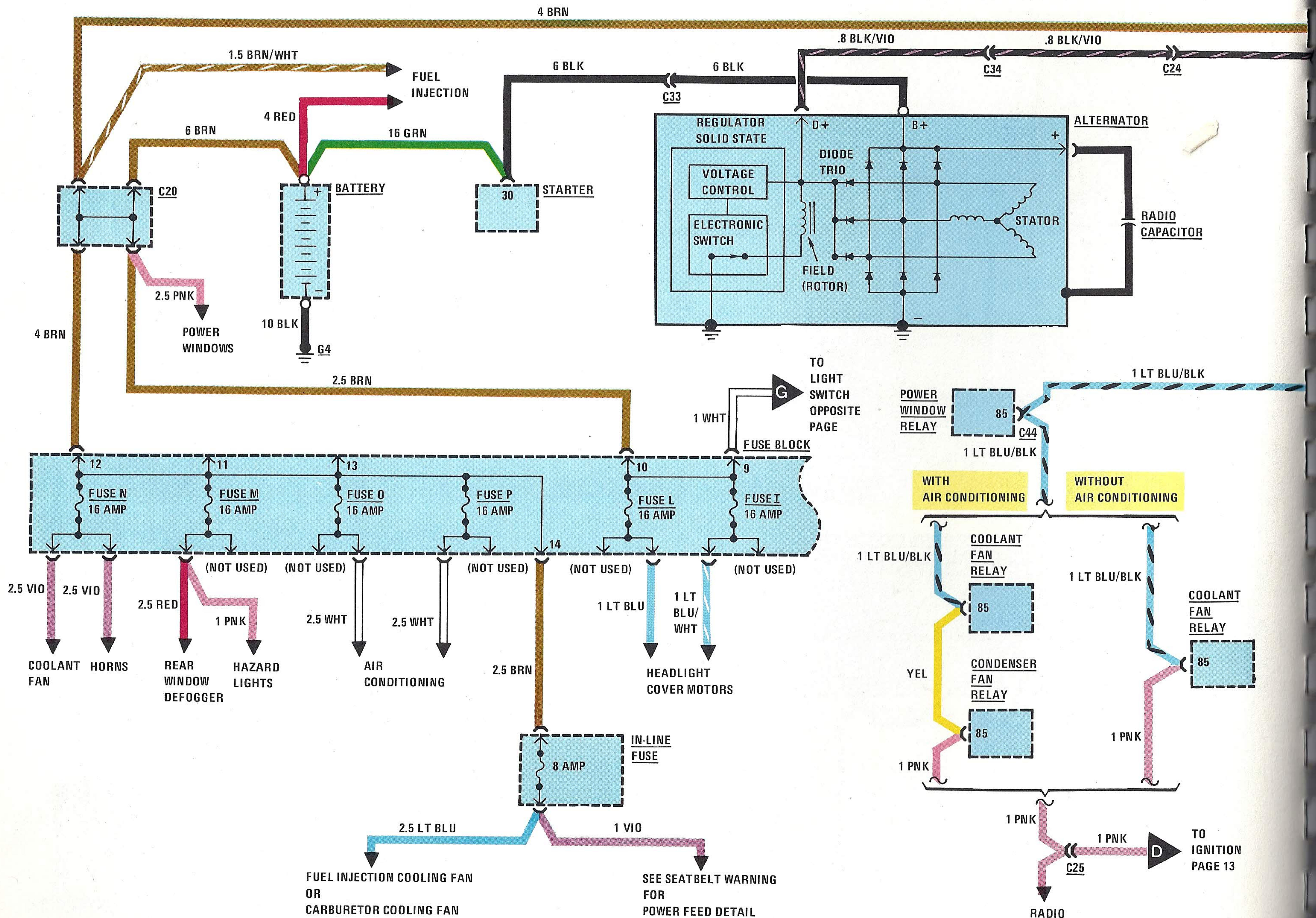

CHARGE/POWER DISTRIBUTION

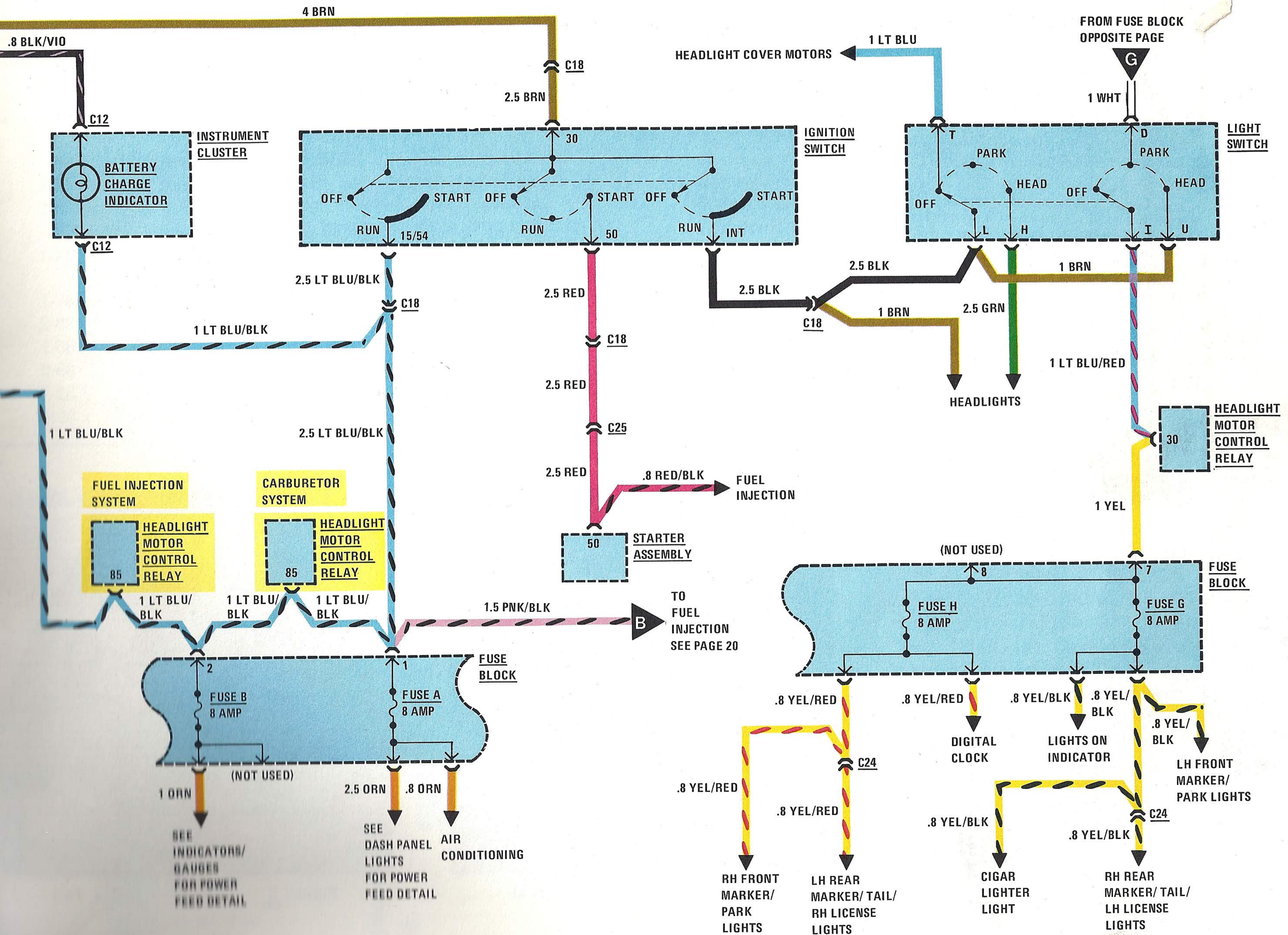

CIRCUIT OPERATION

Charge

With the IGNITION SWITCH in "Run," 12 volts are applied through C20, the BRN wire, IGNITION SWITCH terminals 30 and 15/54 and the BATTERY CHARGE INDICATOR.

If the ALTERNATOR is not working, current flows through the BATTERY CHARGE INDICATOR and the ALTERNATOR D+ terminal to ground. The bulb goes on.

If the ALTERNATOR is working, it powers all car electrical equipment and charges the BATTERY. Alternating current is generated by the stator as the field rotates. The rectifier bridges change the alternating current to direct current. Equal voltage is applied through terminal D+ to the other side of the indicator bulb. The indicator bulb does not go on.

The amount of DC voltage produced by the ALTERNATOR is controlled by the regulator. When the ALTERNATOR output voltage is low, the regulator increases current flowing through the field. This increases the ALTERNATOR output voltage (at terminal B+). Field current is supplied directly from the stator's output through the diode trio.

Power Distribution

These pages show circuits with common power feeds. Use these pages as a reference when you have a problem that can't be solved by looking at an individual circuit page.

COMPONENT LOCATION

| | | Page-Figure |
|-------------------------------------|--|-------------|
| Condenser Fan Relay | Attached to relay panel..... | 64-1 |
| Coolant Fan Motor Relay | Attached to relay panel..... | 64-1 |
| Fuse Block | Attached to top rear of relay panel..... | 64-1, 6-1 |
| Headlight Motor Control Relay | Attached to relay panel | |
| Ignition Switch..... | Attached to RH side of steering column | 41-1 |
| In-Line Fuse | Above relay panel | 39-2 |
| Light Switch | To left of steering column on dash panel.... | 41-1 |
| Power Window Relay | Attached to relay panel..... | 64-1 |
| Starter..... | Part of starter assembly | |
| C18 (4 cavities) | Behind instrument cluster | 47-1 |
| C20 (4 cavities) | To LH side of relay panel | 39-2 |
| C24 (12 cavities) | Above relay panel | 35-1 |
| C25 (12 cavities) | Above relay panel | 39-2 |
| C34 (1 cavity) | RH side of engine compartment..... | 32-2 |
| G4..... | Behind battery, attached to cowl..... | 59-4 |

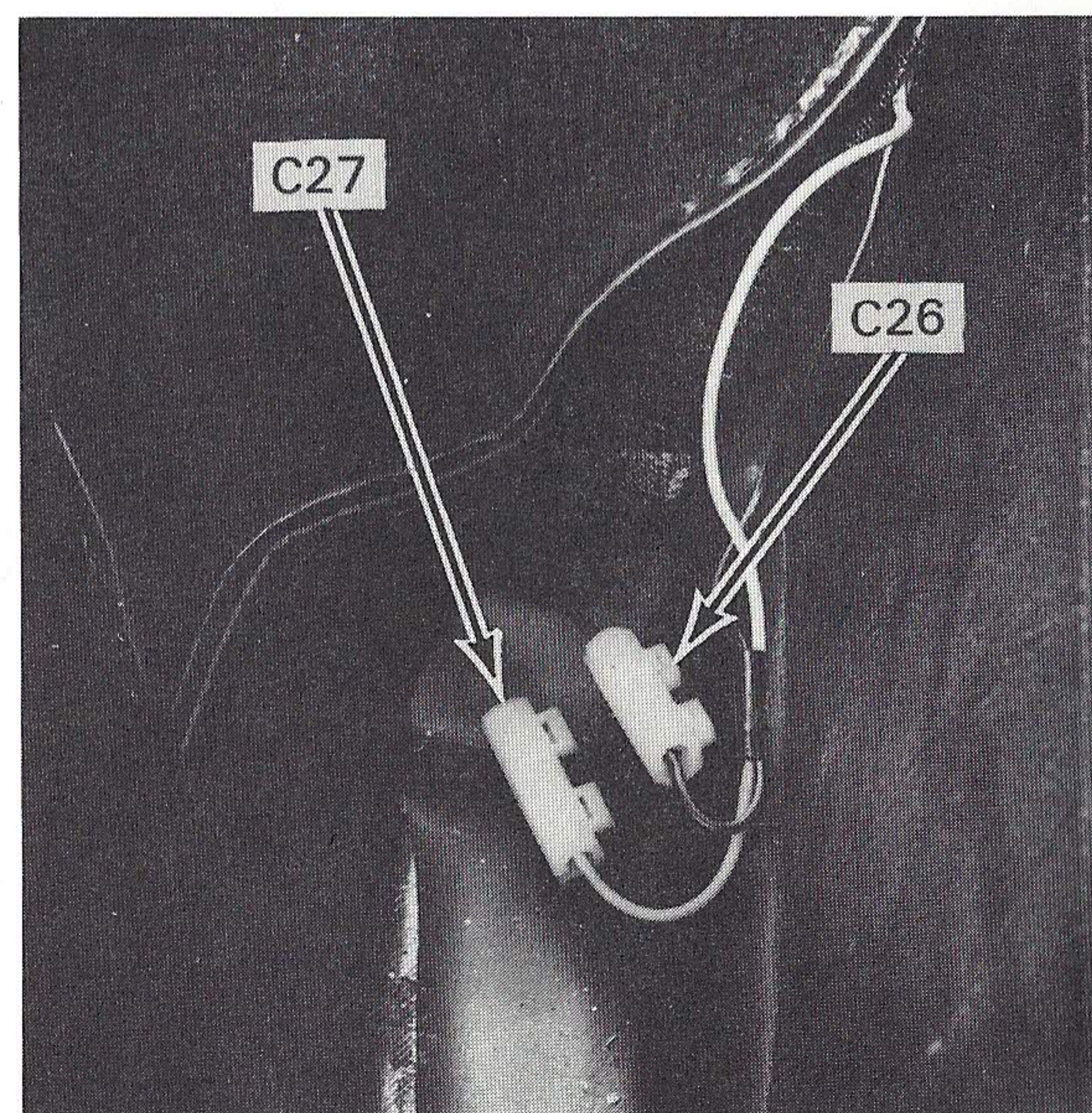

Figure 1 — Under Driver's Seat



Figure 2 — To Left of Spare Tire

HOT IN START OR RUN

D
FROM
POWER
DISTRIBUTION
SEE PAGE 10

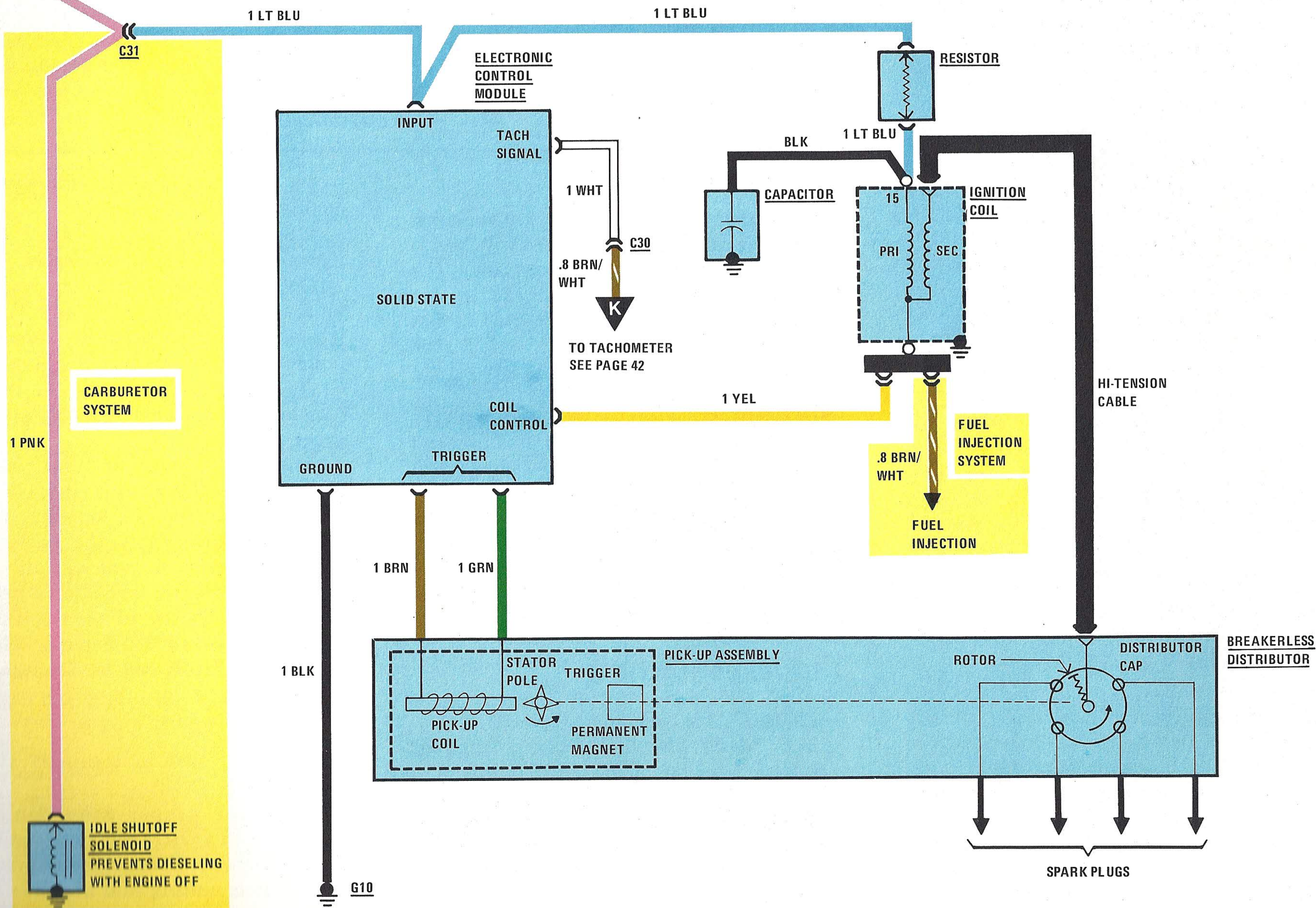

CIRCUIT OPERATION

The Marelli Ignition System consists of an IGNITION COIL, ELECTRONIC CONTROL MODULE, and a BREAKERLESS DISTRIBUTOR. Power is available to the Ignition System when the IGNITION SWITCH is in "Start" or "Run."

Ignition Coil

Voltage is applied from the IGNITION SWITCH through the RESISTOR to the primary coil. The coil current is regulated by the ELECTRONIC CONTROL MODULE, which is triggered by the PICK-UP ASSEMBLY. The PICK-UP ASSEMBLY sends impulses to the module. At the start of each impulse, the module grounds the IGNITION COIL primary through the BLK wire and to G10. When the primary coil circuit is switched on, a strong magnetic field is developed across the primary coil. At the end of each impulse, the circuit is switched off. The strong magnetic field collapses and induces a high voltage in the secondary coil. This high voltage is distributed to spark plugs through the distributor rotor and cap.

Electronic Control Module

The module switches the IGNITION COIL'S primary circuit on and off. It incorporates a constant current limiter to prevent damage to the coil primary circuit. The module also analyzes the impulses from the distributor's pick-up assembly to provide proper dwell time and spark timing regardless of engine rpm. The module also provides the rpm signal to the tachometer, and to the ELECTRONIC CONTROL UNIT (in cars with Fuel Injection)

COMPONENT LOCATION

| | | Page-Figure |
|----------------------------|--|-------------|
| Capacitor | Below RH side of rear window | 50-6 |
| Electronic Control Module. | Under panel on RH side of engine compartment.. | 50-6 |
| Idle Shutoff Solenoid..... | Connected to rear of carburetor | 50-3 |
| Ignition Coil | Below RH side of rear window..... | 15-1 |
| Resistor | Above electronic ignition | 15-2 |
| C30 (1 cavity) | Below ignition coil | 15-1 |
| C31 (1 cavity) | Below ignition coil | 15-1 |
| G10..... | Attached to coil mounting hardware | |

Breakerless Distributor

The distributor is driven by the camshaft of the engine. The distributor shaft has a trigger in place of a breaker cam. The PICK-UP ASSEMBLY mounted in the distributor is electrically connected to the ELECTRONIC CONTROL MODULE

Pick-Up Assembly

The assembly consists of a pick-up coil, stator pole, and a permanent magnet. The assembly creates a magnetic field. The trigger has four teeth, 90 degrees apart. As a tooth passes through the magnetic field, it causes an electrical impulse in the pick-up coil. This impulse is fed to the ELECTRONIC CONTROL MODULE for controlling the coil primary circuit.

TROUBLESHOOTING

NOTICE: The following **Special Notes** apply to the Marelli Electronic Ignition System:

- **Do Not** energize the ignition unless the coil support base is properly grounded.
- **Do Not** crank the engine with the coil wire disconnected.

— **Do Not** disconnect the coil wire with the engine running.

— **Do Not** start the engine with the instrument cluster disconnected.

— **Do Not** ground the control module lead to the tachometer (WHT and BRN/WHT wires), or use diagnostic equipment (or jumper wires) to ground the primary circuit.

— **Do Not** test for current or voltage by "flashing" terminals to each other or to ground.

— The leads to the distributor pick-up may be disconnected while the engine is running without damaging the system.

— **Do Not** disconnect the battery cables while the engine is running; although the ignition system can withstand a peak of 300 volts (for a period of microseconds), the charging system (alternator/electronic voltage regulator) **will** be damaged

IF STARTER CRANKS BUT ENGINE WILL NOT TURN OVER:

- Check for 12V at terminal 15 of the IGNITION COIL.
- Check for proper grounding of the IGNITION COIL support mounting using an ohmmeter. Connect meter between coil support mounting and negative terminal

of battery. Resistance should read .2 ohms or less.

- Check IGNITION COIL resistance with ohmmeter. First disconnect wires from coil. To measure primary coil, read between terminal 15 and terminal I. Reading should be 0.75 to 0.81 ohms. To measure secondary coil read between terminal I and output to distributor. Reading should be 10,000 to 11,000 ohms.
- Check distributor pick-up coil. Remove connector from the ELECTRONIC CONTROL MODULE and, with an ohmmeter, measure resistance of pick-up coil. The reading between the pins of the connector should be 700 to 800 ohms. Then move one of the meter leads to the distributor body to check pick-up insulator. Meter should read infinity (∞).
- Check the gap between stator pole and the teeth of the trigger with a non-magnetic feeler gauge. Reading should be 0.020-0.024 in. (0.5 to 0.6mm).
- Check the ELECTRONIC CONTROL MODULE (only after the pick-up coil has been checked and found to be good).

WARNING: Use insulated pliers to hold HI-TENSION CABLE while testing for spark. A high voltage shock is possible.

Disconnect the HI-TENSION CABLE from the distributor cap. Position the end of the cable a little less than 1/4 of an inch from the engine block. Rotate the engine manually and look for a spark as each tooth of the trigger passes the pick-up. This check can also be made with the distributor removed by manually rotating the distributor shaft.

IDLE SHUTOFF (Carburetor System)

CIRCUIT OPERATION

With the IGNITION SWITCH in "Start" or "Run," current flows through the IDLE SHUTOFF SOLENOID to ground. The solenoid operates and allows fuel to flow in the carburetor idle circuit. When the IGNITION SWITCH is turned to "Off," the solenoid does not operate and fuel flow is shut off to prevent dieseling.

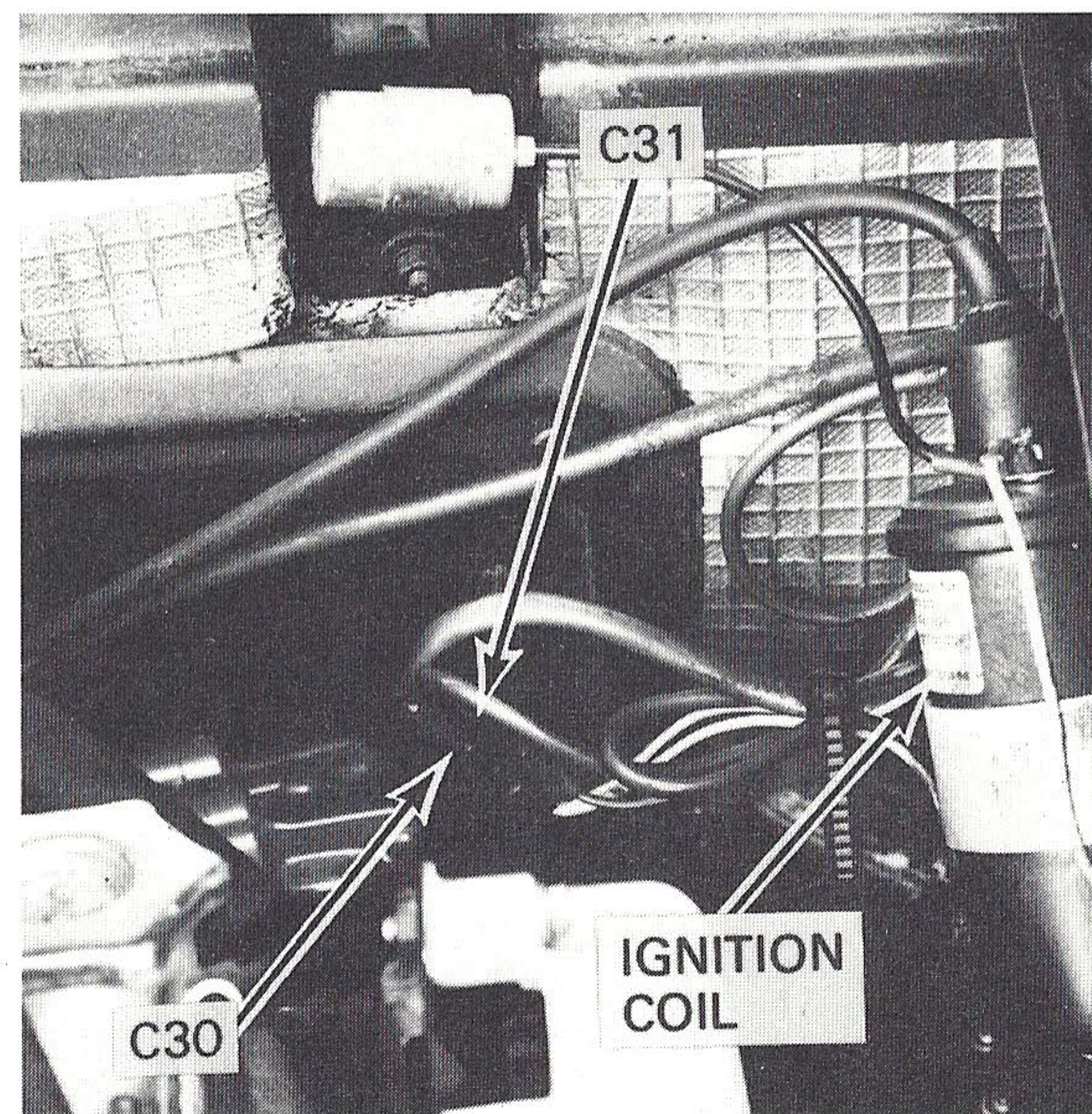

Figure 1 - RH Front of Engine Compartment Wall

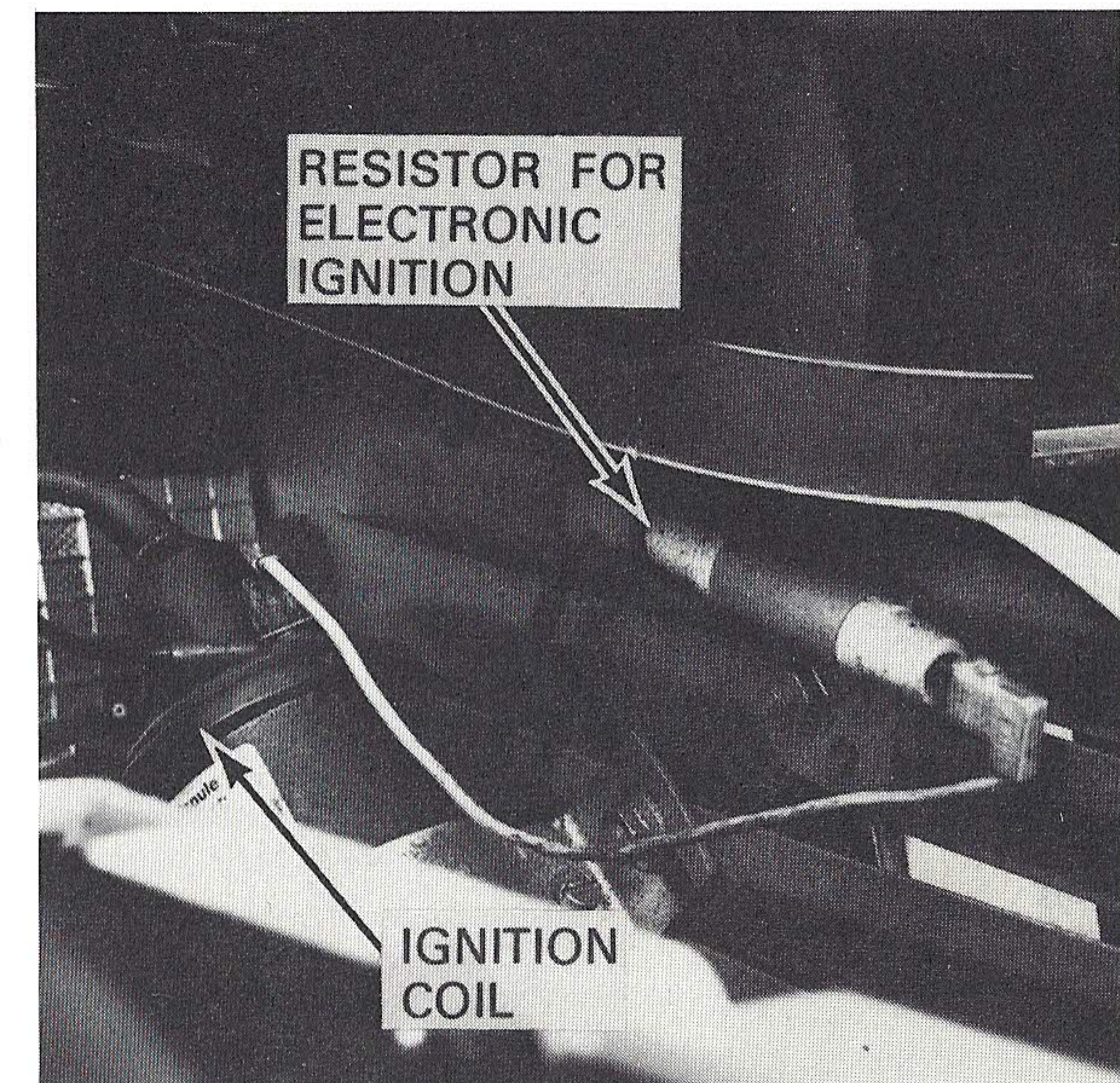

Figure 2 - RH Front of Engine Compartment Wall

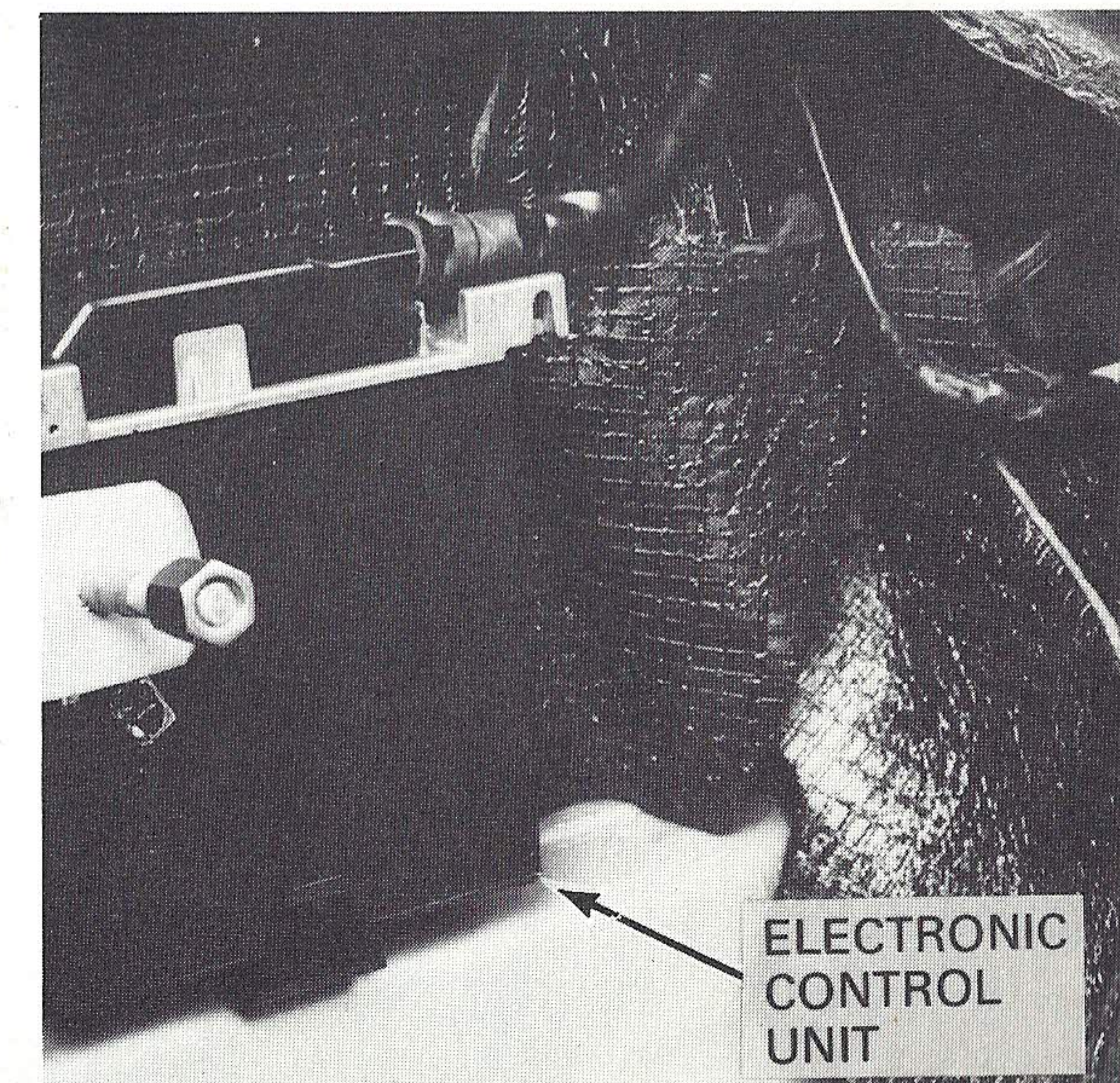
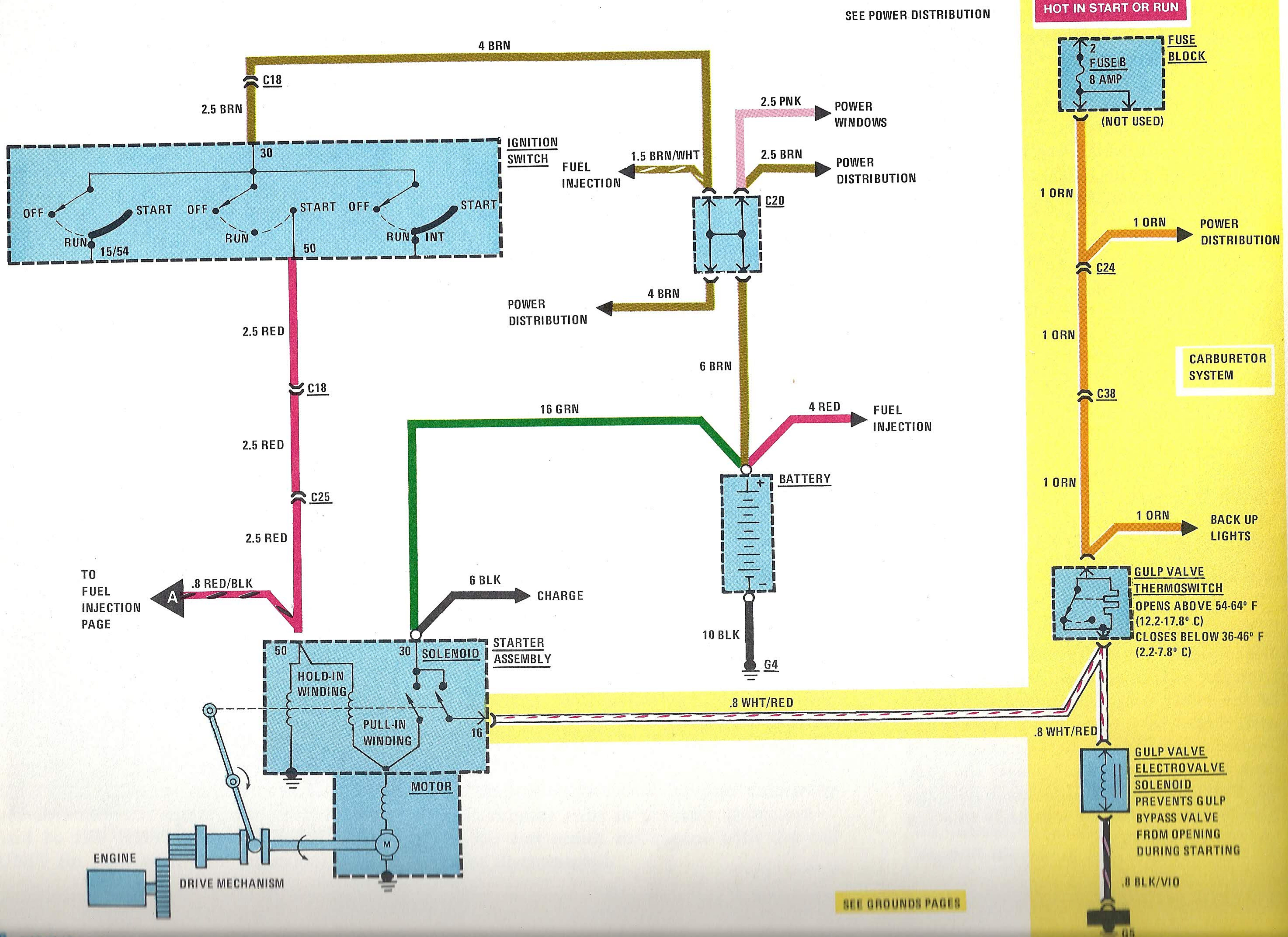

Figure 3 - Behind Spare Tire

STARTER



CIRCUIT OPERATION

Battery voltage is applied at all times to terminal 30 of the SOLENOID, and terminal 30 of the IGNITION SWITCH.

When the IGNITION SWITCH is moved to "Start," current flows through terminal 50 of the SOLENOID, and both the hold-in and pull-in windings (to ground). The hold-in and pull-in windings work together magnetically to pull in the shifter. Current through the pull-in winding also flows through the MOTOR. The MOTOR begins to turn slowly to insure easy meshing of the gear teeth. As the gears mesh, the SOLENOID contacts close. This applies full battery voltage directly to the MOTOR through terminal 30.

When the IGNITION SWITCH is released from "Start," current from the IGNITION SWITCH stops. Current from the BATTERY through the SOLENOID contacts now flows in the reverse direction through the pull-in winding, then continues in normal direction through the hold-in winding. The magnetic force of the hold-in winding is opposed and cancelled by the reverse current through the pull-in winding. The drive mechanism is spring-released and opens the SOLENOID contacts. Voltage to the MOTOR is cut off.

With Carburetor System

During starting, voltage is also applied from the STARTER ASSEMBLY, through the WHT/RED wire, to the GULP VALVE ELECTROVALVE SOLENOID, and to ground. This prevents the gulp bypass valve from opening. In "Start" or "Run," voltage is applied through FUSE B to the

COMPONENT LOCATION

| | | Page-Figure |
|--|--|-------------|
| Fuse Block | Attached to top rear of relay panel | 64-1 |
| Gulp Valve Electrovalve Solenoid | To right of coolant reservoir | 50-2 |
| Gulp Valve Thermostwitch.... | Above spark plug number four | |
| Ignition Switch..... | Attached to RH side of steering column | 41-1 |
| Starter Assembly..... | Lower LH side of engine | |
| C18 (4 cavities) | Behind instrument cluster | 47-1 |
| C20 (4 cavities) | To LH side of relay panel | 39-2 |
| C24 (12 cavities) | Above relay panel | 35-1 |
| C25 (12 cavities) | Above relay panel | 39-2 |
| C38 (1 cavity)..... | Above relay panel | |
| G4..... | Behind battery, attached to cowl..... | 59-4 |
| G5..... | To left of engine, attached to compartment wall..... | 39-3 |

GULP VALVE THERMOSWITCH. With ambient temperature below 36-46°F (2.2-7.8°C), the thermostwitch contacts are closed. Current flows through FUSE B, the thermostwitch, the GULP VALVE ELECTROVALVE SOLENOID, and to ground. The gulp bypass valve does not open. With temperature above 54-64°F (12.2-17.8°C), the thermostwitch opens, cutting off current to the solenoid. The gulp bypass valve opens. During starting, current always flows from the STARTER ASSEMBLY through the solenoid.

With Fuel Injection System

During starting, voltage is directed through the RED/BLK wire to the Fuel Injection circuit.

TROUBLESHOOTING

IF STARTER MOTOR DOESN'T RUN:

- Check BATTERY for full charge.
- Check that G4 is clean and tight.

- Check that STARTER ASSEMBLY terminal 30 and BATTERY connections are clean and tight.

IF GULP VALVE ELECTROVALVE DOESN'T ENERGIZE IN "START":

- Check that G5 is clean and tight.

IF GULP VALVE ELECTROVALVE DOESN'T ENERGIZE WITH AMBIENT TEMPERATURE BELOW 36-46°F (2.2-7.8°C):

- Check GULP VALVE THERMOSWITCH.

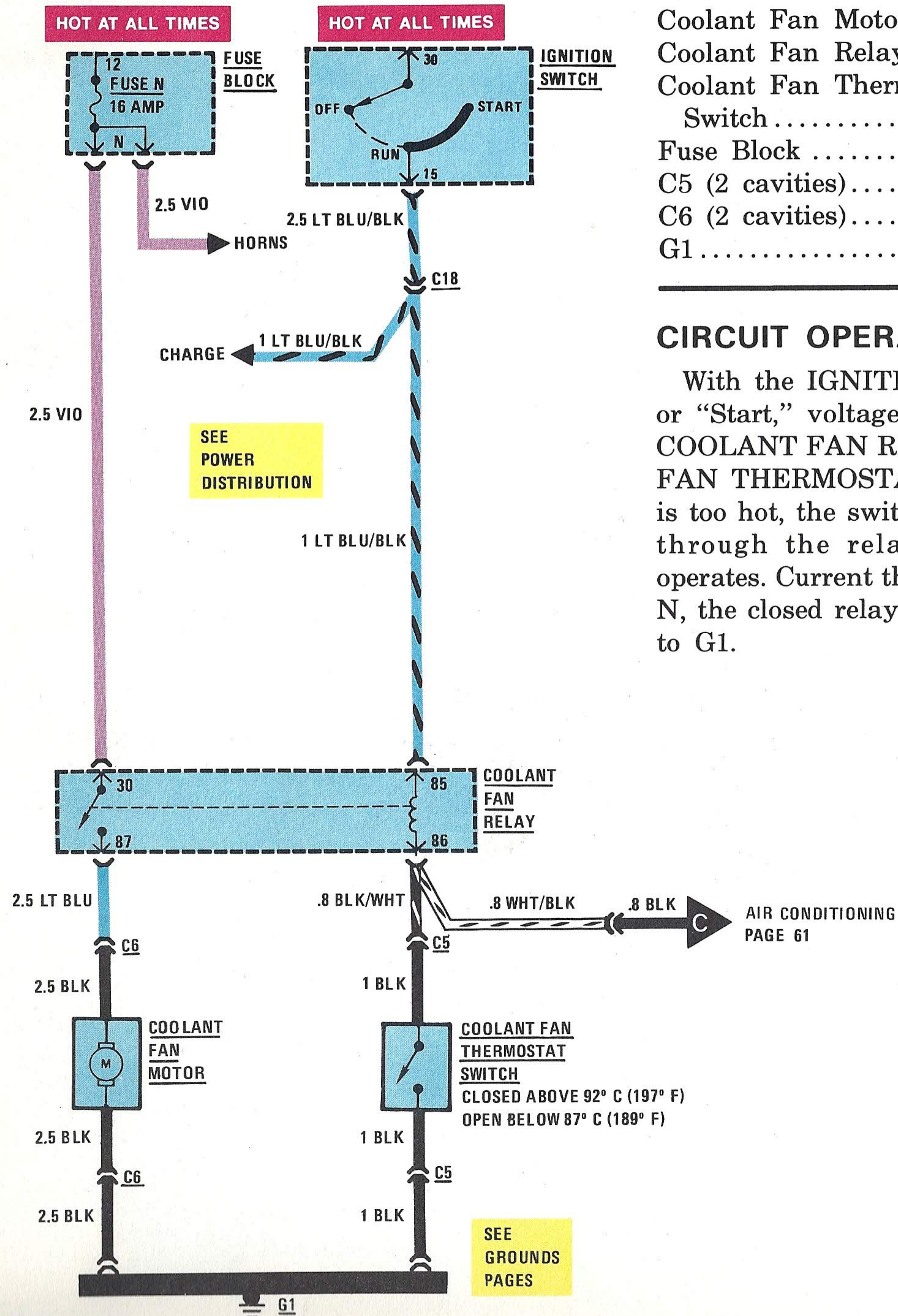

COMPONENT LOCATION

| | | |
|-------------------------------|-------------------------------------|------|
| Coolant Fan Motor | Behind radiator | |
| Coolant Fan Relay | Attached to relay panel | 64-1 |
| Coolant Fan Thermostat Switch | Rear LH side of radiator | 50-3 |
| Fuse Block | Attached to top rear of relay panel | 64-1 |
| C5 (2 cavities) | Behind LH center of radiator | 67-6 |
| C6 (2 cavities) | Behind radiator fan | 67-6 |
| G1 | Behind LH headlights | 27-1 |

CIRCUIT OPERATION

With the IGNITION SWITCH in "Run" or "Start," voltage is applied through the COOLANT FAN RELAY to the COOLANT FAN THERMOSTAT SWITCH. If coolant is too hot, the switch closes. Current flows through the relay coil and the relay operates. Current then flows through FUSE N, the closed relay contacts and the motor to G1.

TROUBLESHOOTING

IF COOLANT FAN MOTOR DOESN'T RUN:

- Check FUSE N by sounding HORN.
- Check continuity of COOLANT FAN THERMOSTAT SWITCH.

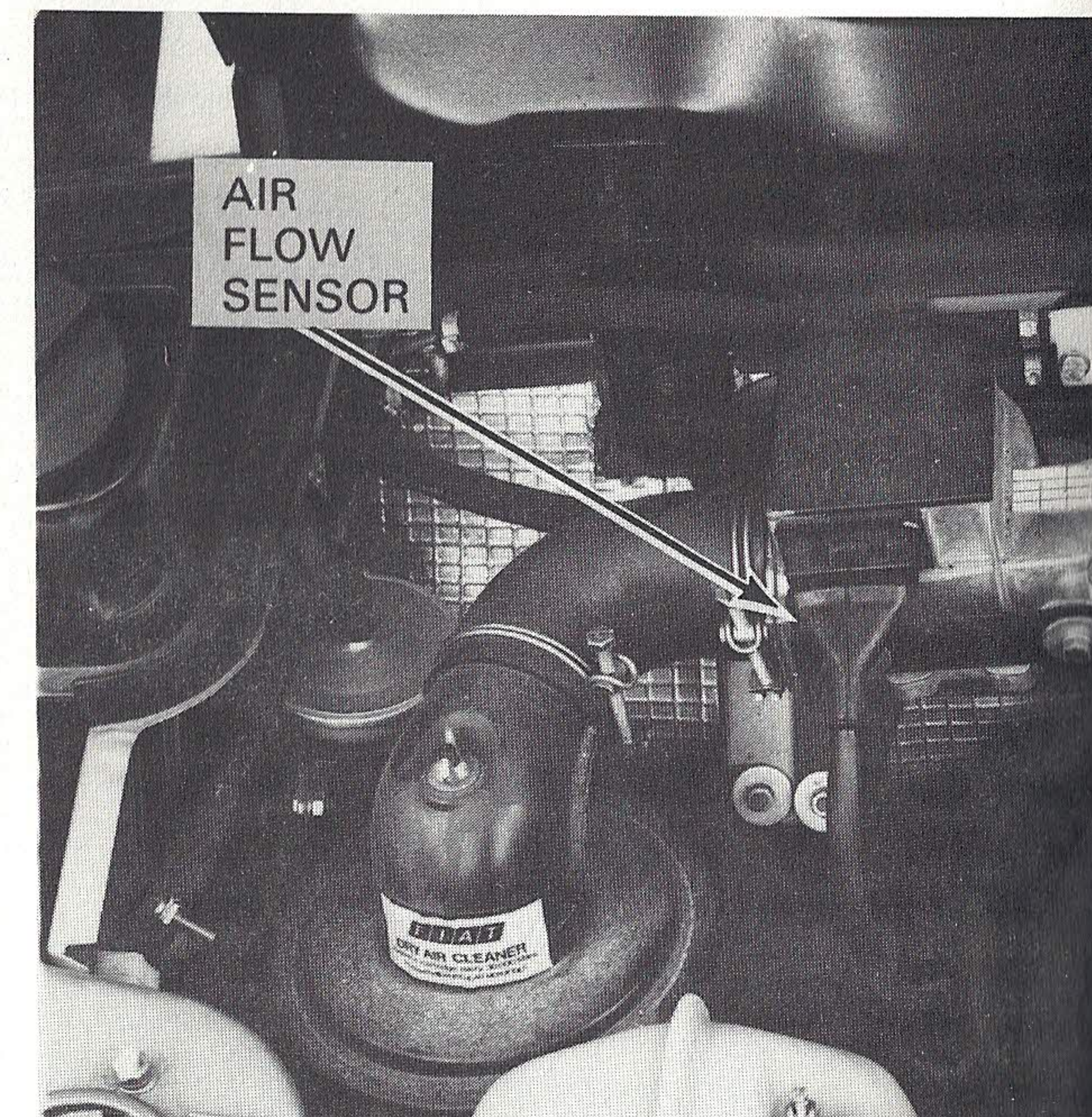
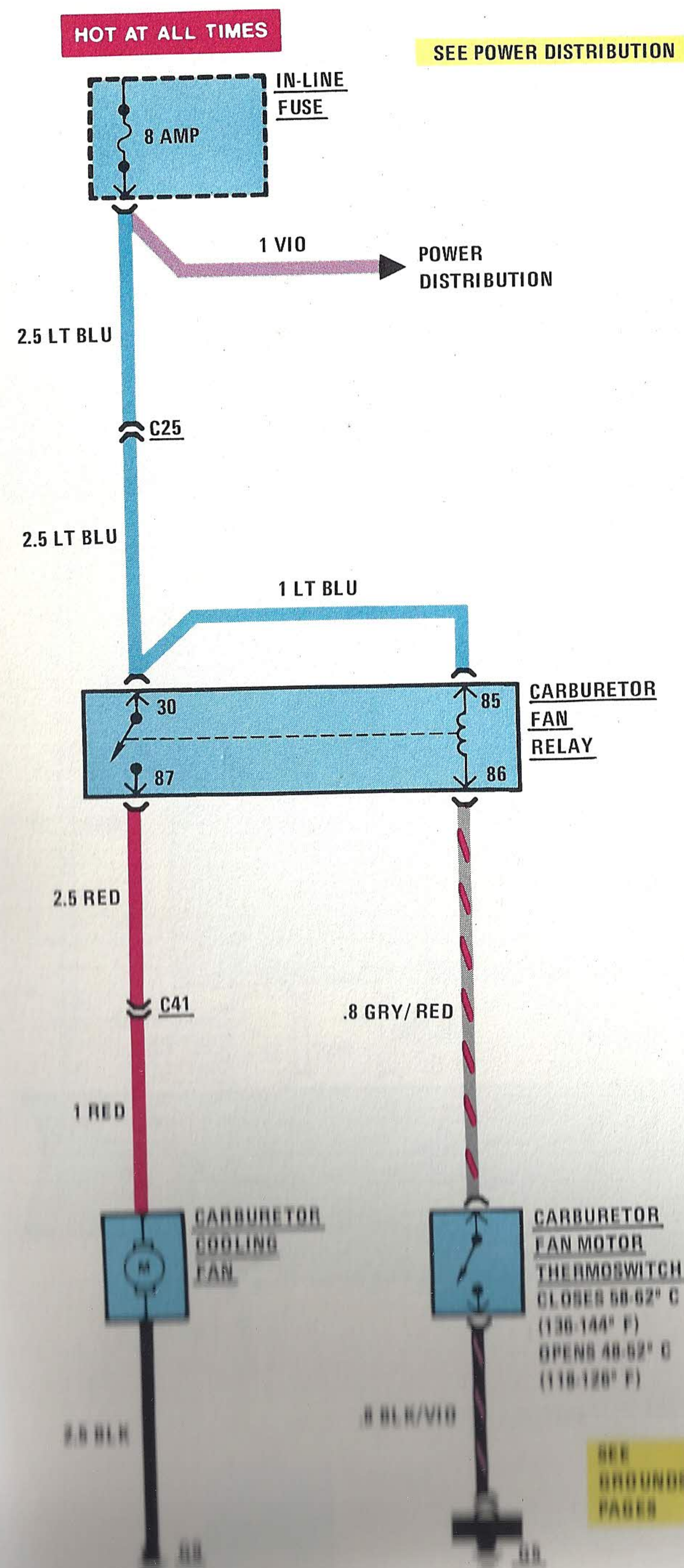

Figure 1 — LH Side of Engine Compartment



COMPONENT LOCATION

| | | |
|------------------------------|--|------|
| Carburetor Cooling Fan | Behind LH wheel well | |
| Carburetor Fan Motor | | |
| Thermo Switch | Connected to rear of carburetor | |
| Carburetor Fan Relay | Behind rear mat, to left of spare tire | 12-2 |
| In-Line Fuse | Above relay panel | 39-2 |
| C25 | Above relay panel | 39-2 |
| C41 | In front of park brake switch | 39-3 |
| G5 | To left of engine, attached to engine compartment wall | 39-3 |
| G9 | Near intake manifold carburetor fan motor | |

CIRCUIT OPERATION

Voltage is applied at all times to terminals 30 and 85 of the CARBURETOR FAN RELAY. When the carburetor temperature goes above 58°-62°C (136°-144°F), the CARBURETOR FAN MOTOR THERMOSWITCH closes causing current to flow through the IN-LINE FUSE, CARBURETOR FAN RELAY coil, and CARBURETOR FAN MOTOR THERMOSWITCH to ground. The relay operates, closing its contacts. Current flows through terminals 30 and 87 of the CARBURETOR FAN RELAY, and the CARBURETOR COOLING FAN to ground. The fan operates. When the carburetor temperature drops below 48°-52°C (118°-126°F), the CARBURETOR FAN MOTOR THERMOSWITCH opens. The relay contacts open and the CARBURETOR COOLING FAN stops running.

TROUBLESHOOTING

IF THE CARBURETOR COOLING FAN DOESN'T WORK:

- Check IN-LINE FUSE by noting if DIGITAL CLOCK works.
- Check that G5 and G9 are clean and tight.
- Use a jumper wire to ground terminal 86 of the CARBURETOR FAN RELAY. If the CARBURETOR COOLING FAN works, replace the CARBURETOR FAN MOTOR THERMOSWITCH. If the CARBURETOR COOLING FAN does not work with terminal 86 of the relay grounded, check for 12 volts at C41. If 12 volts is present, repair or replace CARBURETOR COOLING FAN. If 12 volts is not present, repair or replace CARBURETOR FAN RELAY.

SEE GROUNDING PAGES

FUEL INJECTION

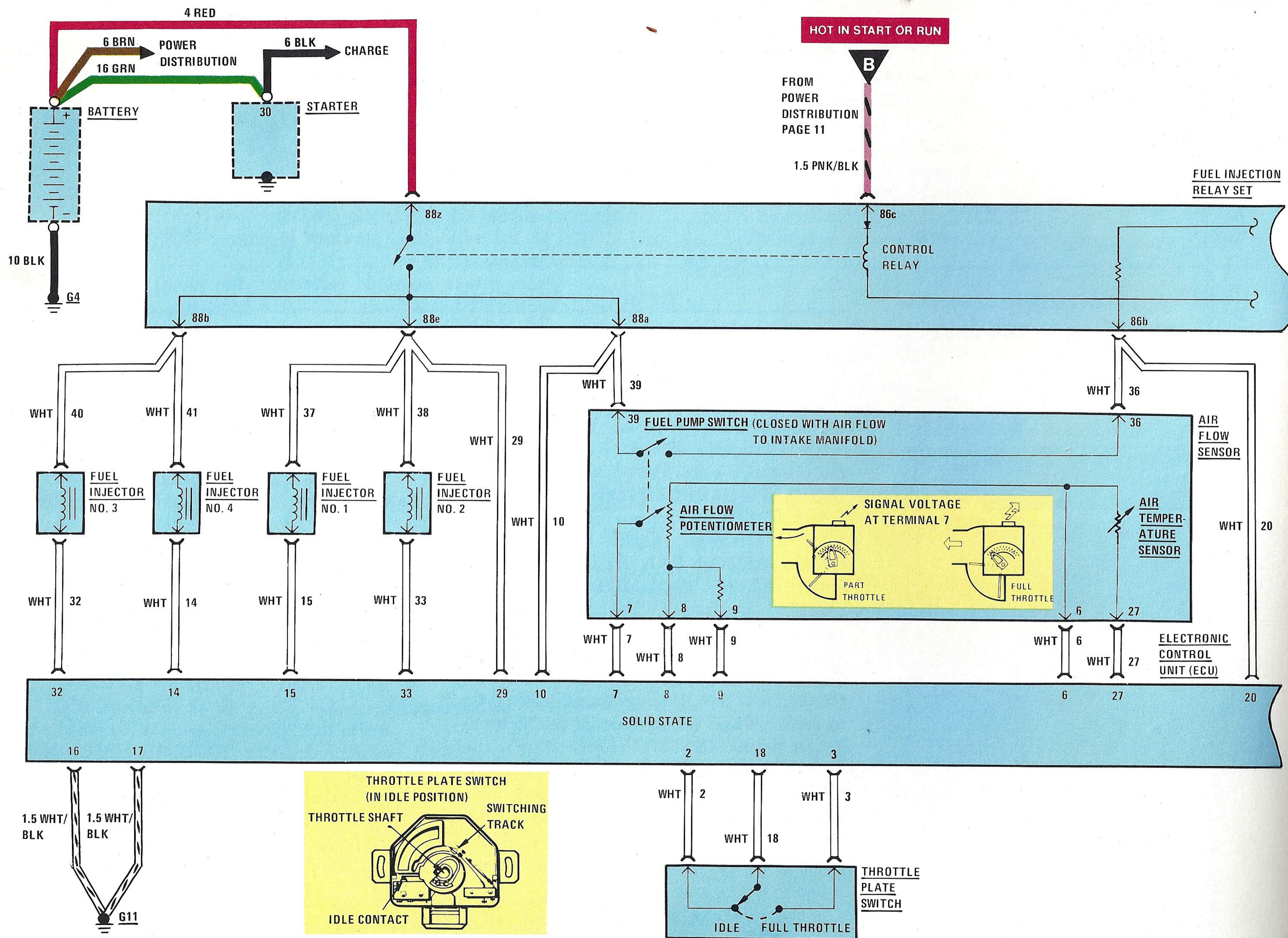

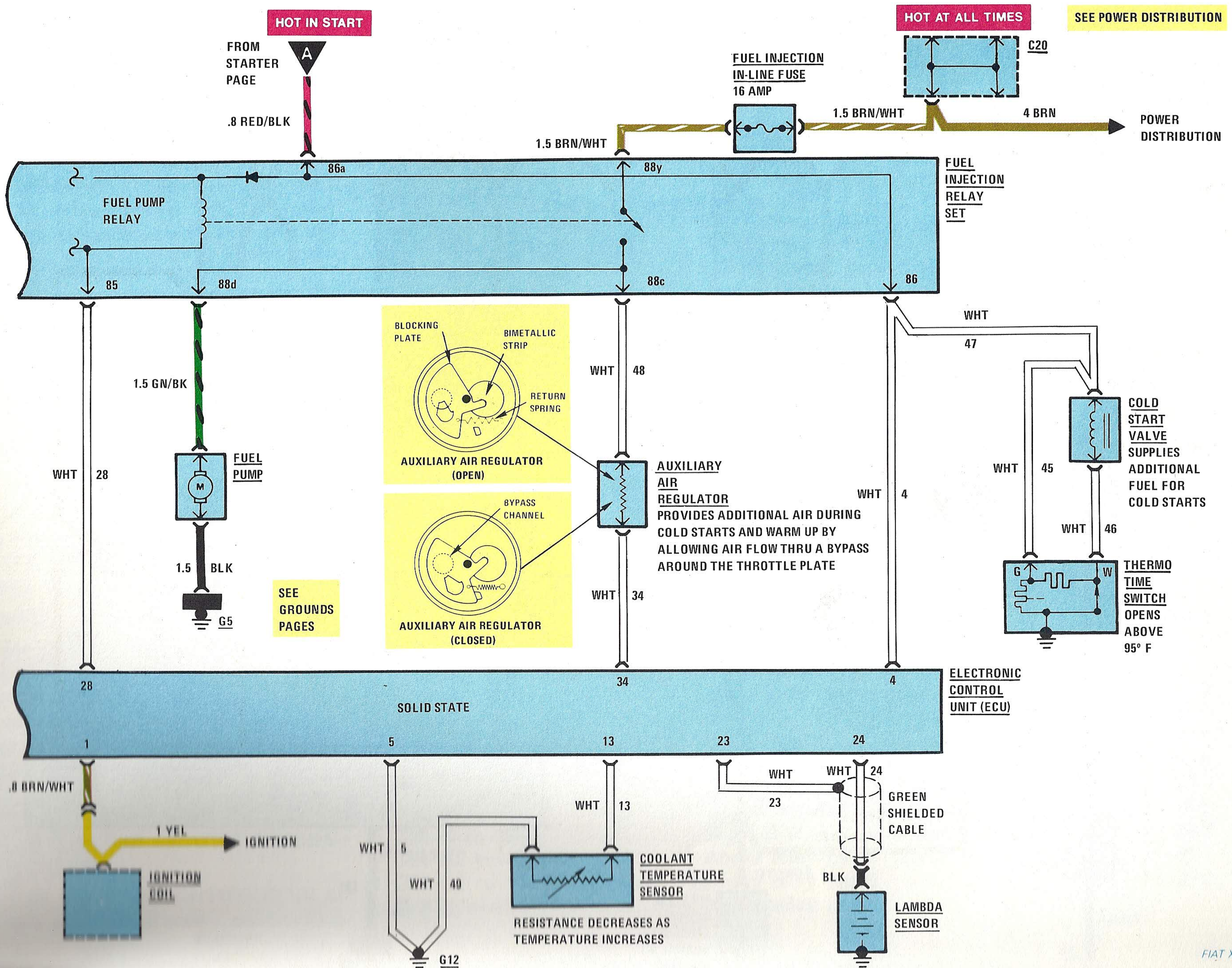

CIRCUIT OPERATION

The Fuel Injection System senses the amount of fuel needed for the proper air/fuel mixture. The fuel is sprayed into the air stream in the intake manifold. Fuel Injection is made up of three major systems: the fuel system, air system and electrical system.

A brief description of each major system will aid in understanding how the entire Fuel Injection System operates electrically.

Fuel System

The fuel system consists of four FUEL INJECTORS, one for each cylinder. The injectors deliver pulses of fuel at the correct pressure to the intake manifold and are controlled by the ELECTRONIC CONTROL UNIT (ECU).

The system also provides additional fuel for cold starting. This is done by the COLD START VALVE, which is controlled by the THERMO TIME SWITCH. The COLD START VALVE operates with the IGNITION SWITCH in "Start" and the THERMO TIME SWITCH closed.

Air System

The air system measures the amount of air drawn into the engine, as well as its temperature, and provides this data to the ECU as input signals. The system also provides bypass air circuits for cold starting and air conditioning.

The AIR FLOW SENSOR contains an AIR FLOW POTENTIOMETER, a FUEL PUMP SWITCH and an AIR TEMPERATURE SENSOR.

The AIR FLOW POTENTIOMETER is linked to a plate which senses air flow into

COMPONENT LOCATION

| | | Page-Figure |
|---------------------------------------|---|-------------|
| Air Flow Sensor | Above LH side of engine | 18-1 |
| Auxiliary Air Regulator | Front LH side of engine, below air flow sensor..... | 50-4 |
| Cold Start Valve | Connected to LH side of engine..... | 25-3 |
| Coolant Temperature Sensor | LH side of engine connected to coolant hose joint..... | 50-4 |
| Diode | Above relay panel | |
| Electronic Control Unit | Behind spare tire | 15-3 |
| Fuel Injection In-Line | | |
| Fuse | Above relay panel | 35-1 |
| Fuel Injection Relay Set | Behind rear mat, to left of spare tire | 12-2 |
| Fuel Injectors | Top of engine, between intake manifold and valve cover | 50-5 |
| | Behind LH wheel well | 53-2 |
| Fuel Injectors Fan Motor | | |
| Fuel Injectors Fan Motor Relay | Behind rear mat, to left of spare tire | 12-2 |
| Fuel Injectors Fan Motor Switch | Attached to RH rear of valve cover | |
| Fuel Pump..... | Below and in front of dry air cleaner | |
| Fuse Block | Attached to top rear of relay panel | 64-1, 6-1 |
| Ignition Coil | Below RH side of rear window | 15-1 |
| In-Line Fuse | Above relay panel | 35-1 |
| Lambda Sensor | Connected to rear of exhaust pipe, below exhaust manifold | 25-3 |
| | Behind center console | 25-2 |
| Lambda Sensor Switch Unit. | | |
| Oil Pressure Switch | Lower front center of engine | |
| Seatbelt Relay | Attached to relay panel..... | 64-1 |
| Seatbelt Timer | Attached to relay panel..... | 64-1 |
| Starter..... | Part of starter assembly | |
| Thermo Time Switch | Above spark plug number two..... | 33-2 |
| Throttle Plate Switch | In front of intake manifold | 50-5 |
| C12 (6 cavities) | Connected to LH rear of instrument cluster . | 27-2 |
| C14 (6 cavities) | Behind instrument cluster | 59-3 |
| C16 (8 cavities) | Behind instrument cluster | 47-1 |
| C17 (6 cavities) | To left of windshield washer reservoir | 25-1 |
| C20 (4 cavities) | Top LH side of relay panel | 39-2 |
| C24 (12 cavities) | Above relay panel | 35-1 |
| C25 (12 cavities) | Above relay panel | 39-2 |
| C38 (1 cavity) | Above relay panel | |

the engine. The potentiometer senses the position of the plate and sends a voltage signal to the ECU for fuel metering.

When air flow is present, the FUEL PUMP SWITCH closes. This energizes the fuel pump relay coil. The relay contacts close and the FUEL PUMP is operated.

The AIR TEMPERATURE SENSOR measures air temperature and provides an input signal to the ECU. The ECU uses the signal to adjust the amount of time each FUEL INJECTOR is open (to compensate for cold air intake).

The AUXILIARY AIR REGULATOR controls air flow through a bypass around the throttle plate. This provides additional air during cold starts and warm-up. The ECU responds to this additional air by metering more fuel to the engine, raising the idle speed.

Electrical System

The electrical system controls the flow of fuel in order to have the correct air/fuel ratio for all operating conditions. The ECU receives the input signals and computes the correct output signal to the control relay.

With the IGNITION SWITCH in "Start" or "Run," current flows through terminal 86c of the FUEL INJECTION RELAY SET (relay set), the coil of the control relay, terminals 28 and 5 of the ECU to G11. The control relay contacts close. Current then flows from the BATTERY through the contacts of the control relay, the FUEL INJECTORS, and the ECU to G11. Because the engine is not yet running, there is no air flow and the FUEL PUMP SWITCH remains open.

COMPONENT LOCATION

| | | Page-Figure |
|------------------------|--|-------------|
| (Chart continued) | | |
| C41 (1 cavity) | Near fuel injectors fan motor | 53-2 |
| C42 (4 cavities) | Behind digital clock | 59-2 |
| C51 (5 cavities) | Behind center console | 25-2 |
| G3 | Under dash panel, to left of steering column | |
| G5 | To left of engine, attached to engine compartment wall | 39-3 |
| G9 | Near fuel injectors fan motor | 53-2 |
| G11 | Attached to LH side of valve cover | |
| G12 | Attached to LH side of valve cover | |

With the IGNITION SWITCH in "Start," current also flows through terminal 86a of the relay set and follows three paths: 1) the coil of the fuel pump relay, terminal 85, and the ECU to G11; 2) terminal 86, and the ECU to G12; and 3) terminal 86 to the COLD START VALVE and the THERMO TIME SWITCH.

Path 1 causes the contacts of the FUEL PUMP RELAY to close. Current then flows through C20 (from the BATTERY), the FUEL INJECTION IN-LINE FUSE, the contacts of the fuel pump relay, terminal 88d of the relay set, and the FUEL PUMP, to G5. Current also flows through terminal 88c of the relay set, the AUXILIARY AIR REGULATOR, and the ECU to G11.

Path 2 provides a start signal to the ECU at terminal 4. The ECU is then allowed to ground the FUEL INJECTORS (through G11), allowing them to operate.

Path 3 powers the COLD START VALVE through the THERMO TIME SWITCH (when starting with the coolant temperature below 95°F). The switch remains closed and the COLD START VALVE operates, until: 1) the coolant temperature goes above 95°F; or 2) the current flow through the

heater in the switch generates enough heat to open the switch.

With the IGNITION SWITCH in "Run," current no longer flows from terminal 86a to operate the fuel pump relay. With the engine running, however, there is air flow to the intake manifold. This causes the contacts of the FUEL PUMP SWITCH to close. Current then flows from the BATTERY, through the closed contacts of the control relay, terminal 88a of the relay set, the FUEL PUMP SWITCH, terminal 86b of the relay set, the fuel pump relay coil, terminal 85 of the relay set, ECU terminal 28, and G11. The fuel pump relay contacts remain closed and the FUEL PUMP operates. If the engine stops or stalls, the FUEL PUMP SWITCH opens, stopping the FUEL PUMP.

The LAMBDA SENSOR is located in the exhaust system. It is an oxygen sensor which measures the oxygen concentration of the exhaust gases, and sends an input signal to the ECU.

The COOLANT TEMPERATURE SENSOR provides an input signal that tells the ECU to provide the extra fuel necessary

during warm-up.

The IGNITION COIL sends an input signal to the ECU that provides engine speed information. The ECU constantly controls the FUEL INJECTORS according to this signal. During deceleration, the IGNITION COIL also transmits a deceleration mode signal to the ECU to stop injection of fuel.

The THROTTLE PLATE SWITCH is located on the throttle shaft (which is operated by the accelerator pedal). The switch indicates whether the throttle is at idle, full throttle, or in between. The switch then signals this to the ECU.

Lambda Sensor Switch Unit

When the car is moving, the SPEEDOMETER sends pulses to the LAMBDA SENSOR SWITCH UNIT. The LAMBDA SENSOR SWITCH UNIT contact closes every 30,000 miles. This grounds the "EXH. GAS SENSOR" INDICATOR to remind the owner of the need to replace the LAMBDA SENSOR. When the engine is being started, the OIL PRESSURE SWITCH grounds the "EXH. GAS SENSOR" INDICATOR and OIL PRESSURE WARNING INDICATOR to test the bulbs.

Fuel Injectors Fan

The OIL PRESSURE SWITCH also grounds the FUEL INJECTORS FAN MOTOR SWITCH (fan motor switch). If the fan motor switch is closed, current flows through the IN-LINE FUSE, the FUEL INJECTORS FAN MOTOR RELAY (fan motor relay), the fan motor switch, and the OIL PRESSURE SWITCH. The fan motor relay operates, closing the relay contacts.

Current flows through fan motor relay contacts 30 and 87 to operate the FUEL INJECTORS FAN MOTOR. This keeps the FUEL INJECTORS from overheating when the engine stops after it is hot.

TROUBLESHOOTING

For troubleshooting, refer to the Fuel Injection Diagnosis Manual.

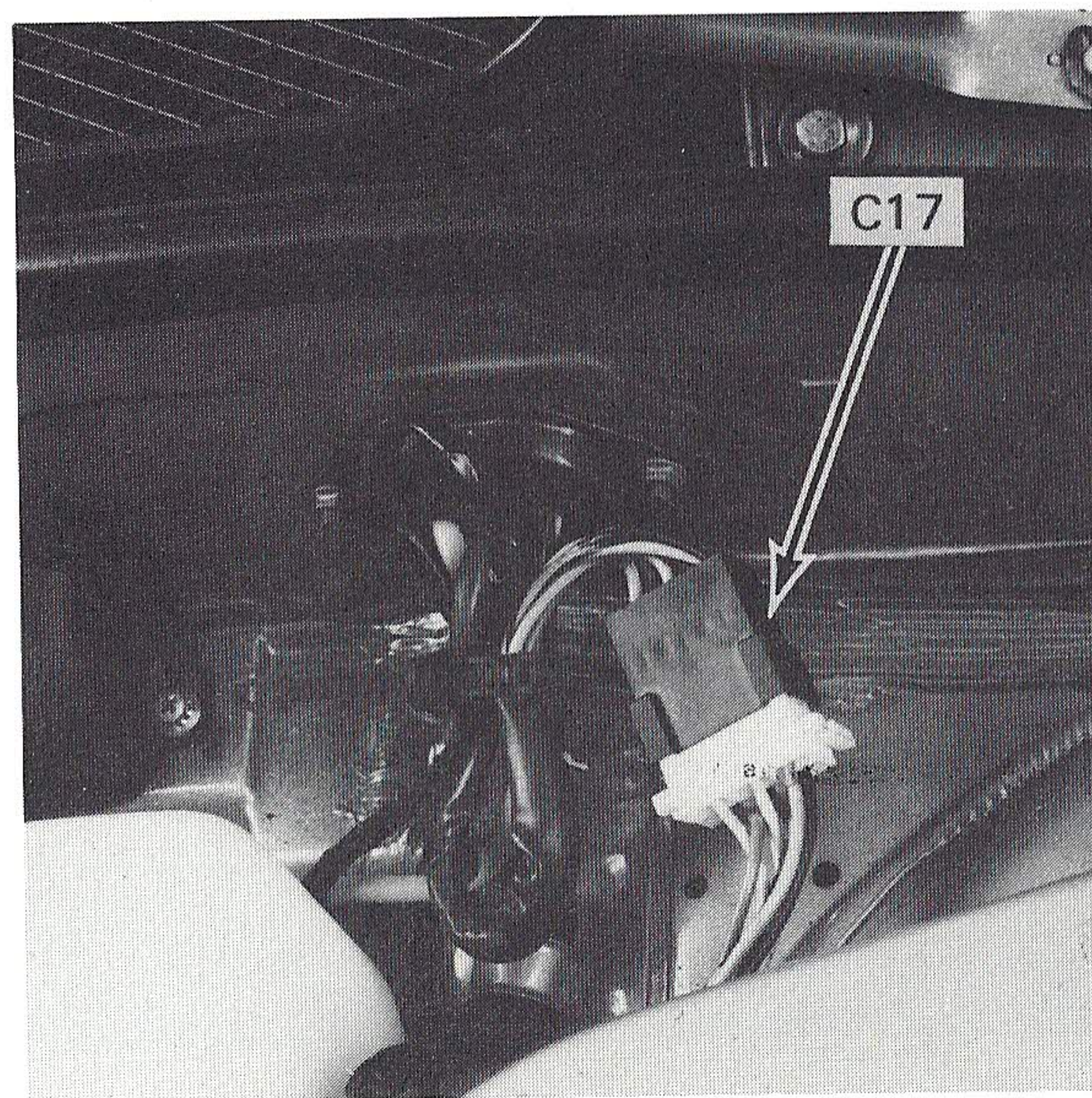

Figure 1 — LH Side of Cowl

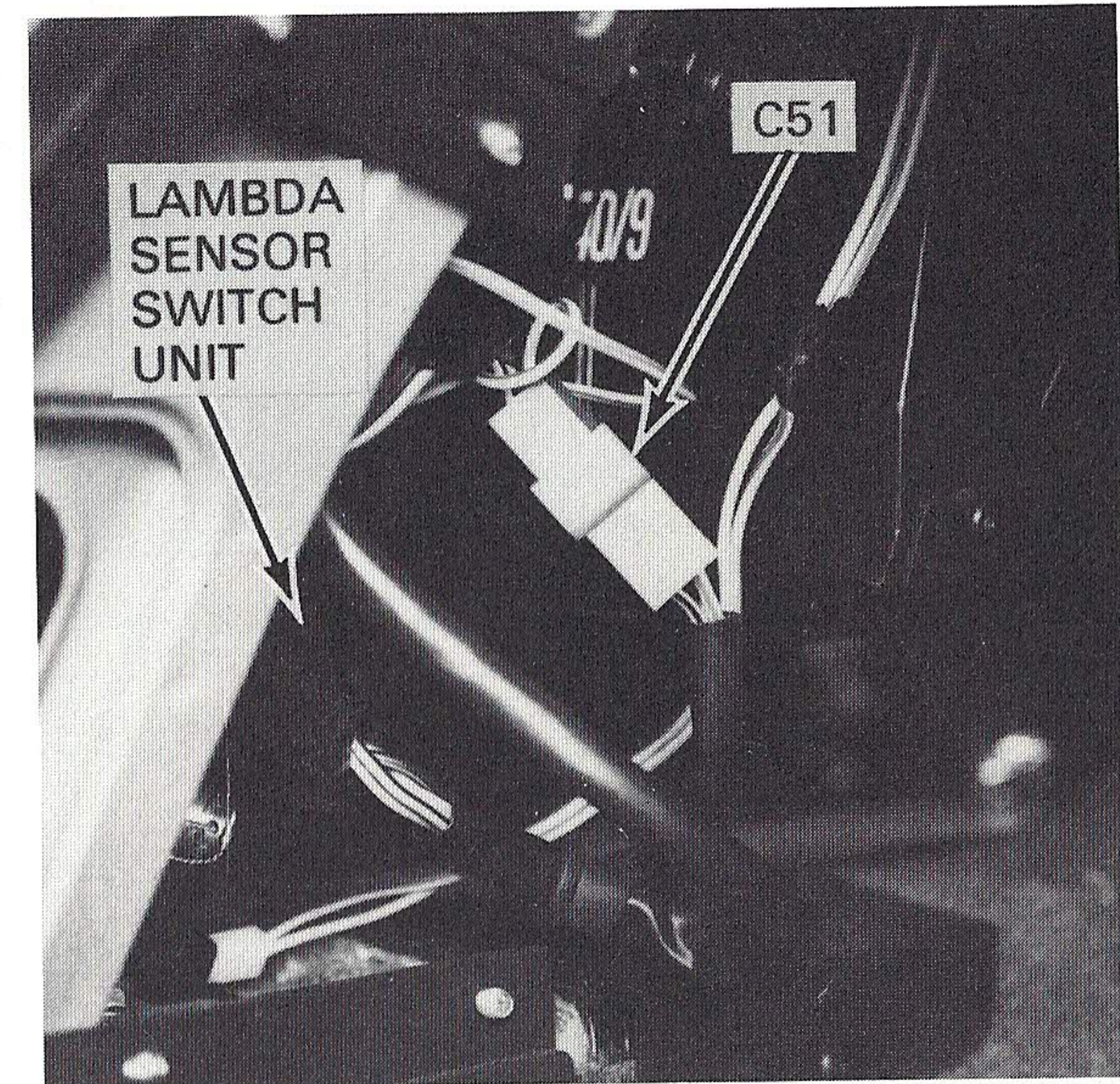

Figure 2 — Behind Center Console

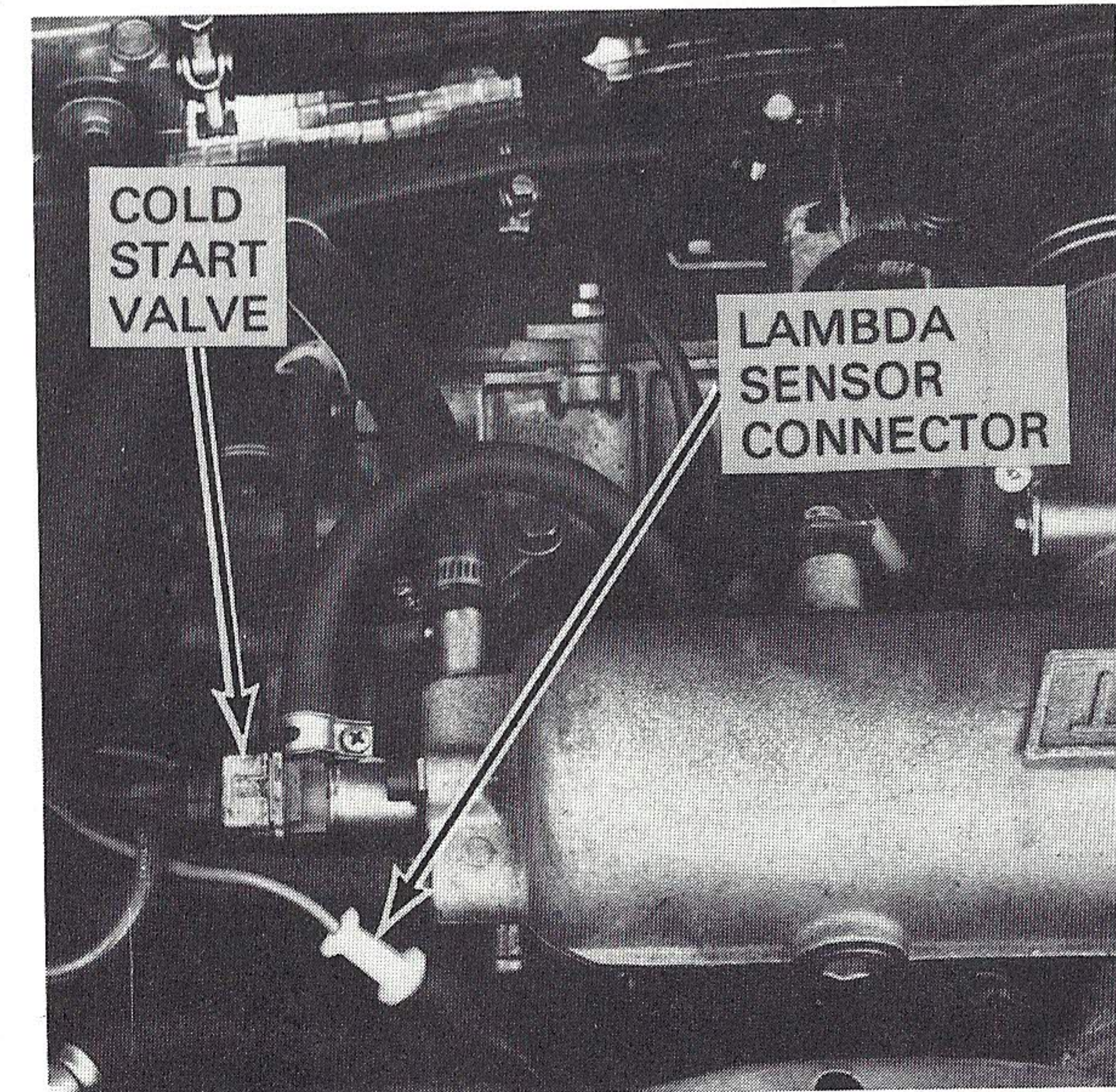
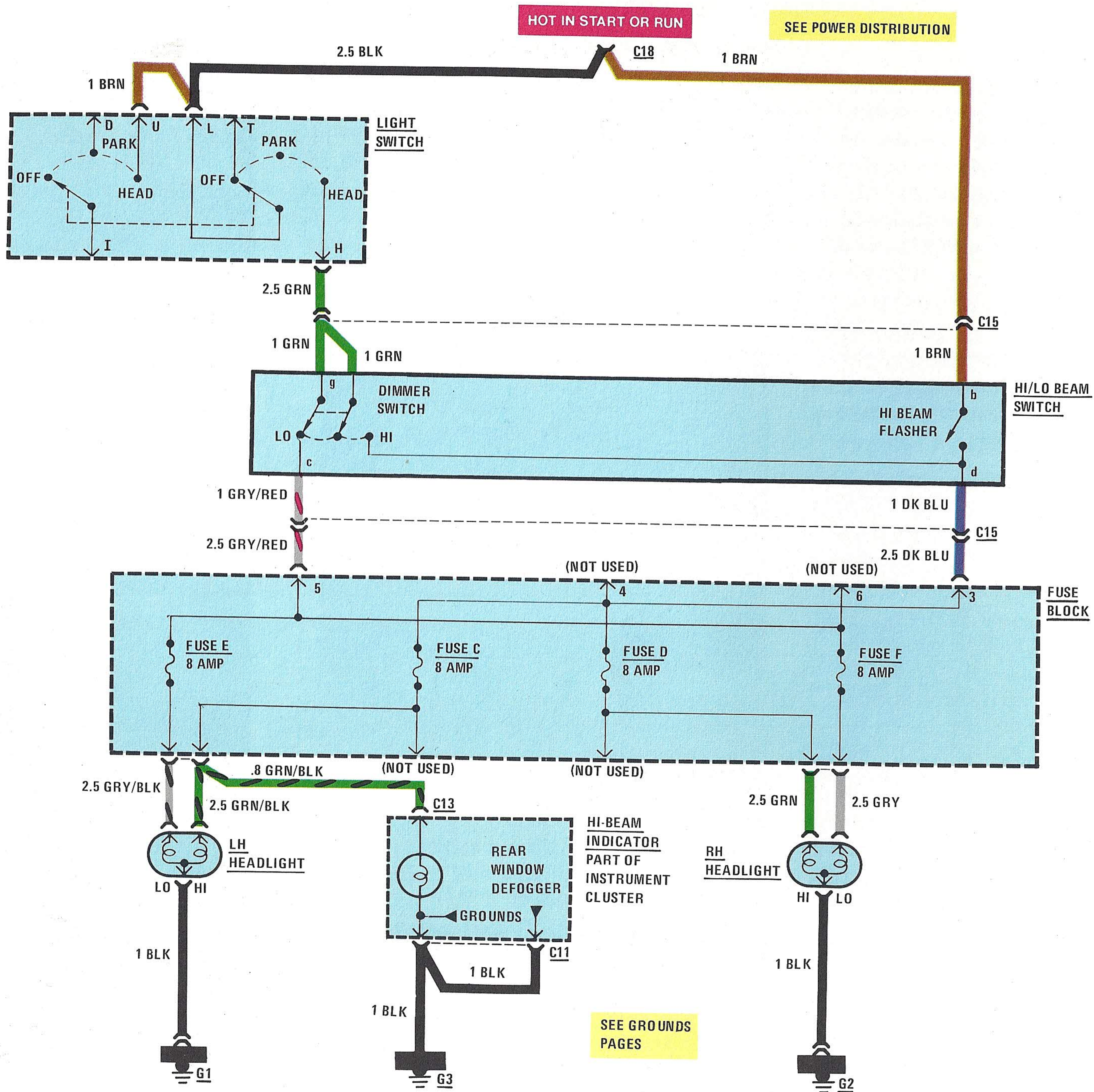

Figure 3 — LH Side of Intake Manifold

HEADLIGHTS



CIRCUIT OPERATION

With the IGNITION SWITCH in "Start" or "Run," voltage is applied to the LIGHT SWITCH and hi-beam flasher of the HI/LO BEAM SWITCH.

With the LIGHT SWITCH in "Head," the dimmer switch of the HI/LO BEAM SWITCH directs current through the FUSE BLOCK to either the "Lo" or "Hi" HEADLIGHT filaments and HI-BEAM INDICATOR. With the dimmer switch in "Lo," current flows through FUSES E and F, the "Lo" HEADLIGHT filaments and to ground. With the dimmer switch in "Hi," current flows through FUSES C and D, the "Hi" HEADLIGHT filaments (to ground) and the HI BEAM INDICATOR.

Voltage available through the BRN wire is used for the hi-beam flasher regardless of the position of the LIGHT SWITCH. With the flasher closed, current flows through the DK BLU wire, and to the "Hi" HEADLIGHT filaments in the same manner as with the dimmer switch in "Hi."

TROUBLESHOOTING

IF ONE HEADLIGHT DOESN'T WORK IN EITHER "HI" OR "LO":

• Check its ground.

IF THE "HI" OR "LO" FILAMENT OF ONE HEADLIGHT DOESN'T WORK:

• Check its FUSE.

• Check the lamp.

IF BOTH HEADLIGHTS DON'T WORK IN "LO":

• Check continuity of dimmer switch in "Lo."

COMPONENT LOCATION

| | | Page-Figure |
|------------------------|--|-------------|
| Fuse Block | Attached to top rear relay panel | 64-1 |
| C11 (5 cavities) | Connected to LH rear of instrument cluster . | 27-2 |
| C13 (8 cavities) | Connected to center rear of instrument cluster | 27-2 |
| C15 (5 cavities) | Behind instrument cluster | 47-1 |
| C18 (4 cavities) | Behind instrument cluster | 47-1 |
| G1 | Behind LH headlights | 27-1 |
| G2 | Behind RH headlights | 32-1 |
| G3 | Under dash panel, to left of steering column | |

IF BOTH HEADLIGHTS DON'T WORK IN "HI."

- Check dimmer switch by operating hi-beam flasher.

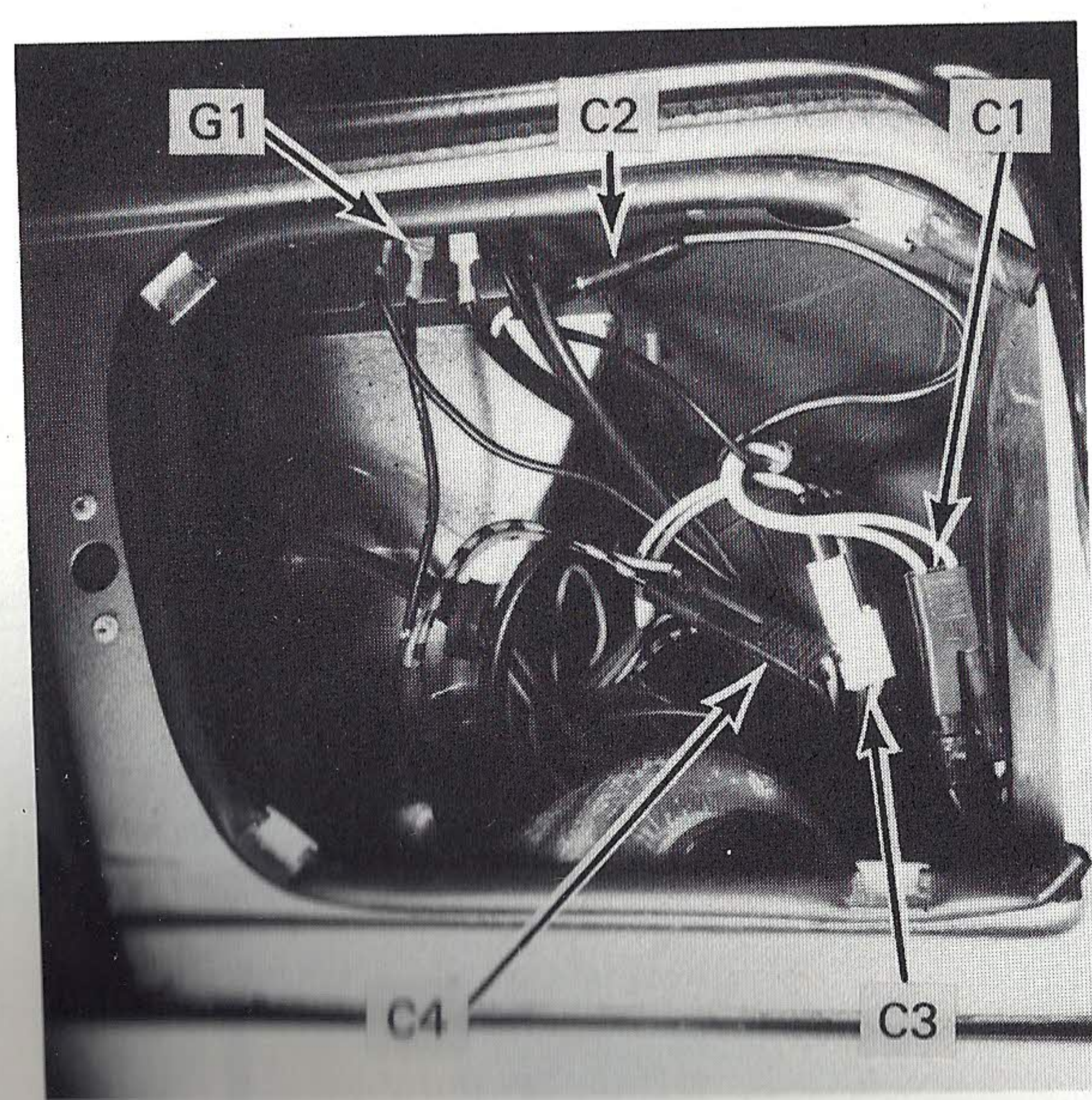

Figure 1 - Behind LH Headlight

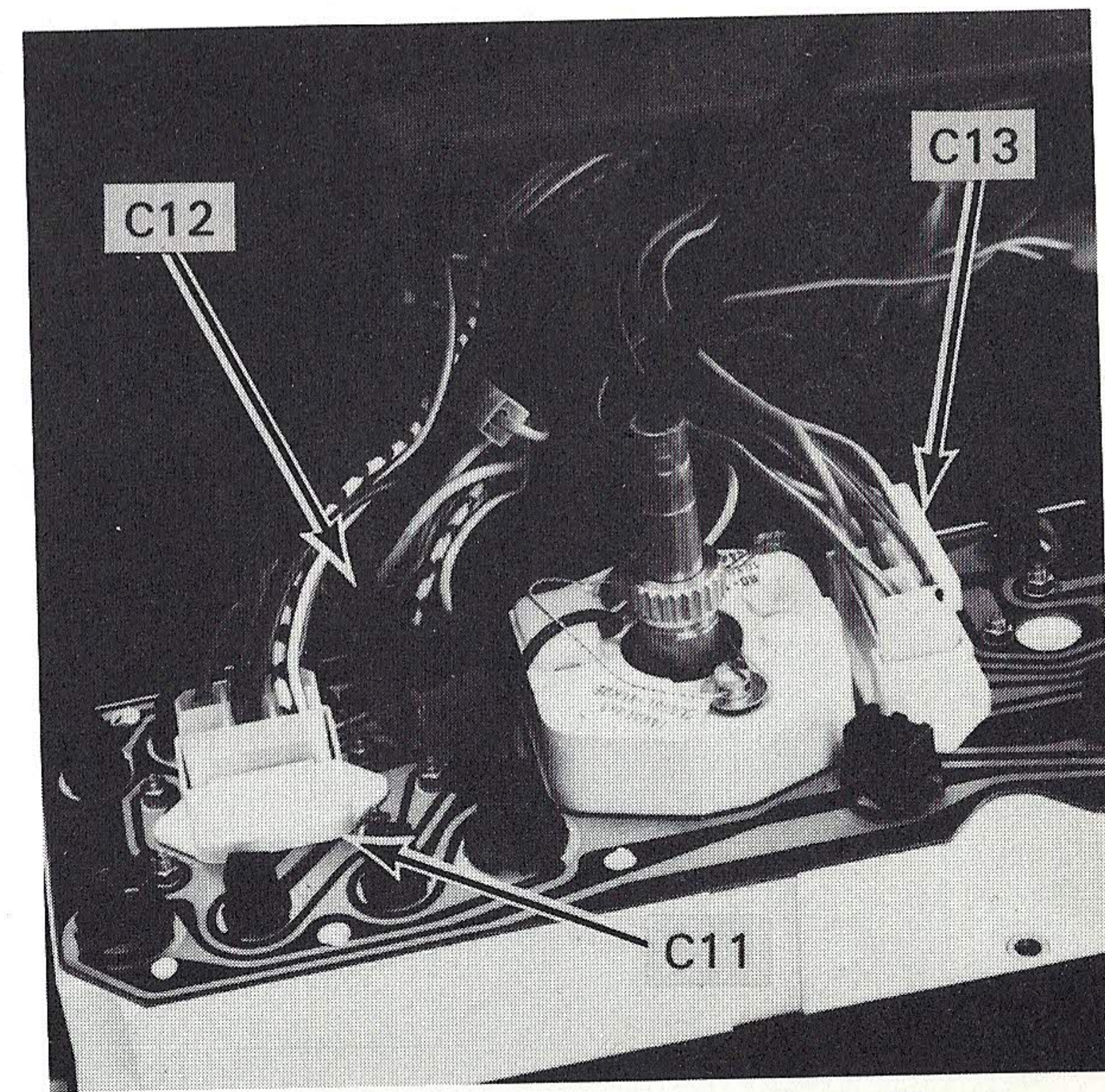
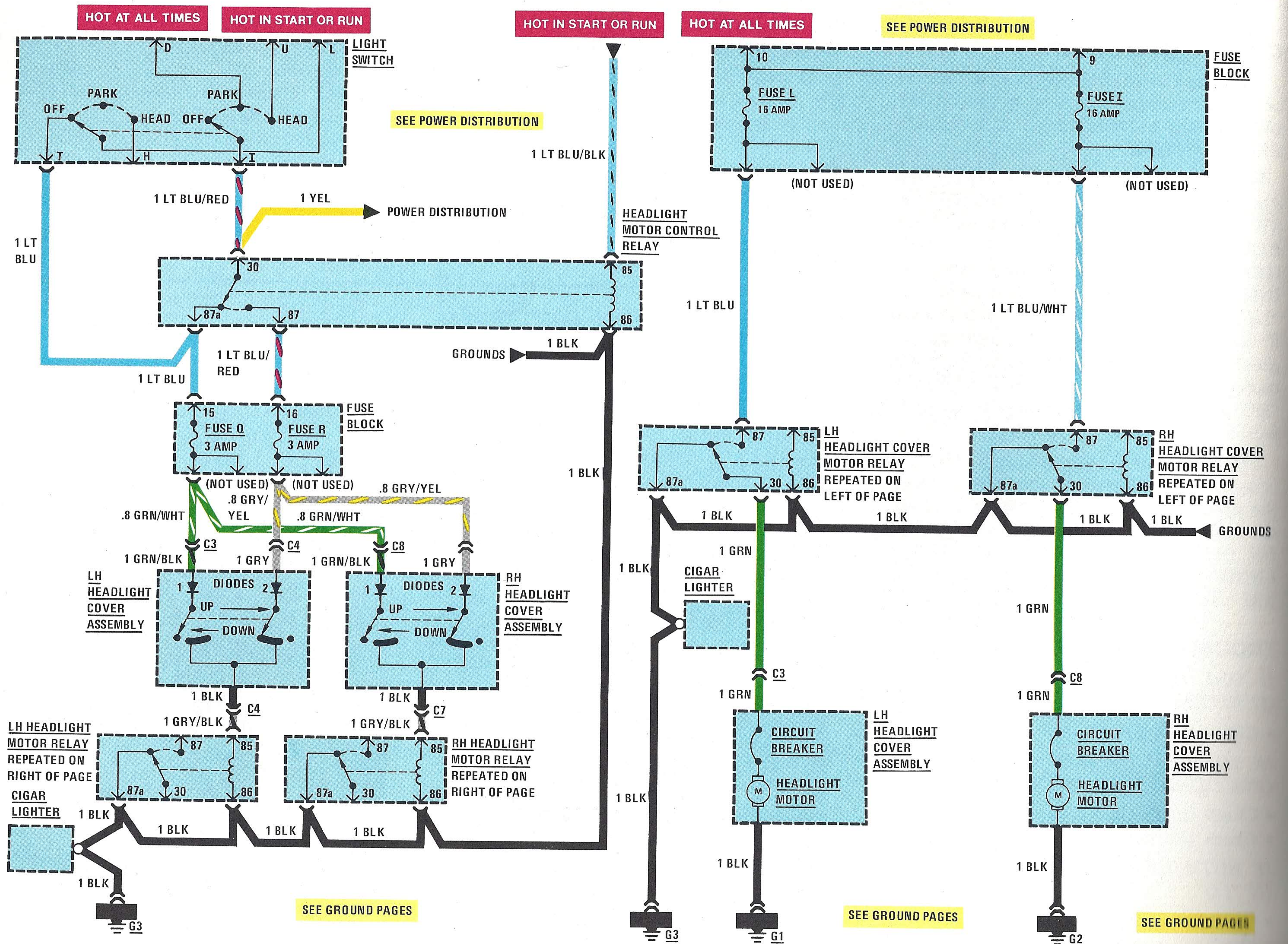

Figure 2 - Back of Instrument Cluster

HEADLIGHT COVER MOTORS



CIRCUIT OPERATION

Voltage is applied at all times to terminal D of the LIGHT SWITCH and FUSES L and I of the FUSE BLOCK. With the IGNITION SWITCH in "Start" or "Run," voltage is applied to terminals U and L of the LIGHT SWITCH and to terminal 85 of the HEADLIGHT MOTOR CONTROL RELAY.

With the IGNITION SWITCH in "Start" or "Run," current flows through the HEADLIGHT MOTOR CONTROL RELAY coil to ground. The relay is energized. If the LIGHT SWITCH is in "Park" or "Head," current flows through the LIGHT SWITCH (terminals D and I or U and I), terminals 30 and 87 of the HEADLIGHT MOTOR CONTROL RELAY and FUSE R. From FUSE R current divides to flow through diodes 2 and the contacts of the LH and RH HEADLIGHT ASSEMBLIES, and the LH and RH HEADLIGHT MOTOR RELAY coils to ground.

With the LH and RH HEADLIGHT MOTOR RELAYS energized, current flows through FUSE L and FUSE I, terminals 87 and 30 of the LH and RH HEADLIGHT MOTOR RELAYS, and the LH and RH HEADLIGHT MOTORS to ground G1. The headlight covers go up.

When the headlight covers are fully up, the switch in each HEADLIGHT ASSEMBLY opens the current path through diode 2. The LH and RH HEADLIGHT MOTOR RELAY coils are de-energized. Each motor stops when its GREEN wire is connected to ground by the HEADLIGHT MOTOR RELAY.

The headlight covers will close in the

COMPONENT LOCATION

| | | |
|-------------------------------------|---|--------------------------|
| Fuse Block | Attached to top rear of relay panel | Page-Figure 64-1, 6-1 |
| Headlight Motors | Part of headlight cover assemblies | |
| Headlight Motor Control Relay | Attached to relay panel | 64-1 |
| Headlight Motor Relays | Attached to relay panel | 64-1 |
| C3 (2 cavities) | Behind LH headlight | 27-1 |
| C4 (2 cavities) | Behind LH headlight | 27-1 |
| C7 (2 cavities) | Behind RH headlight | 32-1 |
| C8 (2 cavities) | Behind RH headlight | 32-1 |
| G1 | Behind LH headlight | 27-1 |
| G2 | Behind RH headlight | 32-1 |
| G3 | Under LH side of dash panel, near steering column | |

same way when the LIGHT SWITCH is turned "Off" (if the IGNITION SWITCH is in "Start" or "Run") beginning with current flowing from LIGHT SWITCH terminal T.

If the IGNITION SWITCH is turned to "Off" with the LIGHT SWITCH in "Head," the covers will remain up. If the IGNITION SWITCH is turned to "Off" with the LIGHT SWITCH in "Park," current flows through the LIGHT SWITCH, terminals 30 and 87a of the HEADLIGHT MOTOR CONTROL RELAY, FUSE Q, diode 1 and the contacts of the LH and RH HEADLIGHT ASSEMBLIES and the LH and RH HEADLIGHT

MOTOR RELAY coils to ground. Current then flows through FUSES L and I, motor relay contacts and HEADLIGHT MOTORS to G1 and G2. The headlight covers go down.

When the headlight covers are fully down, the switches in each HEADLIGHT COVER ASSEMBLY open the current paths through each diode 1. The MOTOR RELAY coils are de-energized. Each motor stops when its GREEN wire is connected to ground by the HEADLIGHT MOTOR RELAY.

Headlight Cover Operation Table

| Ignition Switch | Light Switch | Headlight Covers |
|------------------|--------------|------------------|
| "Off" | "Off" | closed |
| "Off" | "Park" | closed |
| "Start" or "Run" | "Park" | open |
| "Start" or "Run" | "Head" | open |
| "Off" | "Head" | closed |
| "Start" or "Run" | "Off" | closed |

CIRCUIT OPERATION

Turn

With the IGNITION SWITCH in "Start" or "Run," voltage is applied through FUSE A and terminals T and D of the HAZARD SWITCH to the "+" (positive) terminal of the TURN/HAZARD FLASHER. With the TURN SWITCH in "R," current flows through the VIO wires, TURN SWITCH, and LT BLU wires to both the RH FRONT TURN/PARK LIGHT (to G2) and RH REAR TURN LIGHT (to G7). The TURN/HAZARD FLASHER opens and closes the circuit, flashing the lights. The flasher also directs current through the TURN INDICATOR to G3. With the TURN SWITCH in "L," similar current flow takes place to the LH lights.

Hazard

Voltage is applied at all times through Fuse M to terminal V of the HAZARD SWITCH. With the HAZARD SWITCH in "Hazard," current flows through terminal D, the TURN/HAZARD FLASHER, both HAZARD SWITCH terminals I and L, and the REAR TURN LIGHTS and FRONT TURN/PARK LIGHTS to G1, G8, G7 and G2. The flasher opens and closes the circuit as it does for the turn signals, flashing the lights and TURN INDICATOR. Current also flows through the HAZARD INDICATOR to G3.

TROUBLESHOOTING

Turn Lights

IF ALL TURN LIGHTS AND TURN INDICATOR DON'T GO ON:

- Check FUSE A by operating the HEATER FAN MOTOR.

COMPONENT LOCATION

| | | Page-Figure |
|---------------------------|--|-------------|
| Fuse Block | Attached to top rear of relay panel | 64-1, 6-1 |
| Hazard Switch | Upper portion of center console | 41-1 |
| Turn/Hazard Flasher | Attached to top RH side of relay panel | 35-1 |
| Turn Switch | Upper LH side of steering column | 41-1 |
| C1 (2 cavities) | Behind LH headlight | 27-1 |
| C9 (2 cavities) | Behind RH headlight | 32-1 |
| C13 (8 cavities) | Connected to center rear of instrument cluster | 27-2 |
| C14 (6 cavities) | Behind instrument cluster | 59-3 |
| C24 (12 cavities) | Above relay panel | 35-1 |
| G1 | Behind LH headlights | 27-1 |
| G2 | Behind RH headlights | 32-1 |
| G3 | Under dash panel, to left of steering column | |
| G7 | Attached behind RH license plate light | 32-2 |
| G8 | Attached behind RH license plate light | 35-2 |

- Check flasher and C14 by operating HAZARD SWITCH.

- Check for continuity between terminals T and D of HAZARD SWITCH.

IF EITHER REAR TURN LIGHT DOESN'T GO ON:

- Check bulb.

IF BOTH REAR TURN LIGHTS DON'T GO ON:

- Check C24.

IF EITHER FRONT TURN/PARK LIGHT DOESN'T GO ON:

- Check bulb.
- Check that G1 (for LH light) or G2 (for RH light) is clean and tight.

IF ONLY THE PARK OR TURN FILAMENT OF THE TURN/PARK LIGHT WORKS:

- Check the bulb.

Hazard Lights

IF HAZARD LIGHTS DO NOT GO ON:

- Check FUSE M by operating REAR WINDOW DEFOGGER.
- Check flasher by operating TURN LIGHTS.
- Check for continuity between terminals V and D of HAZARD SWITCH.

Indicators (Turn and Hazard)

IF ONLY HAZARD INDICATOR DOES NOT GO ON IN "HAZARD":

- Check continuity between terminal U and C13.

IF BOTH INDICATORS DON'T GO ON IN "HAZARD":

- Check that G3 is secure.

FRONT PARK/FRONT MARKER LIGHTS

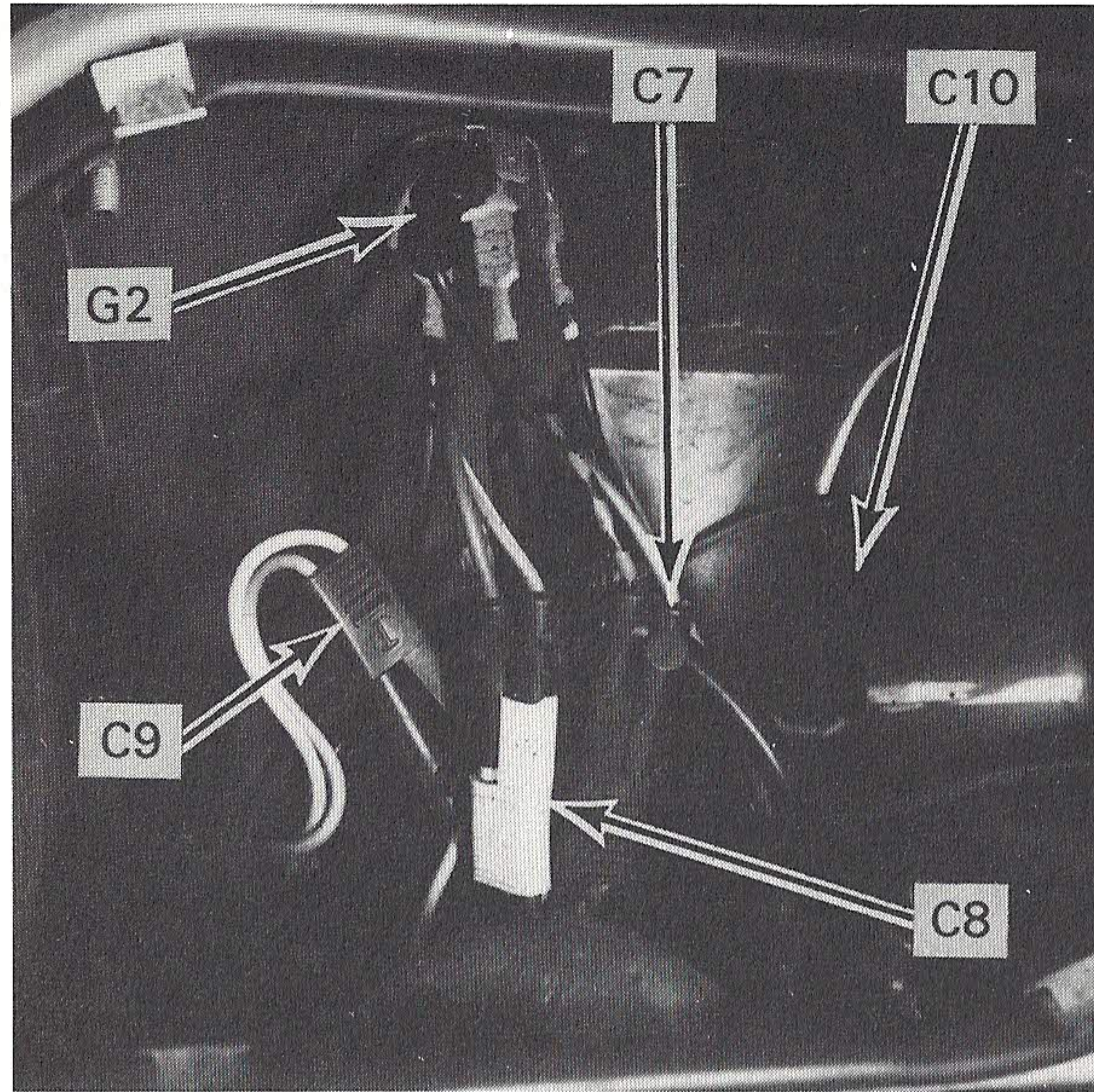

Figure 1 - Behind RH Headlight

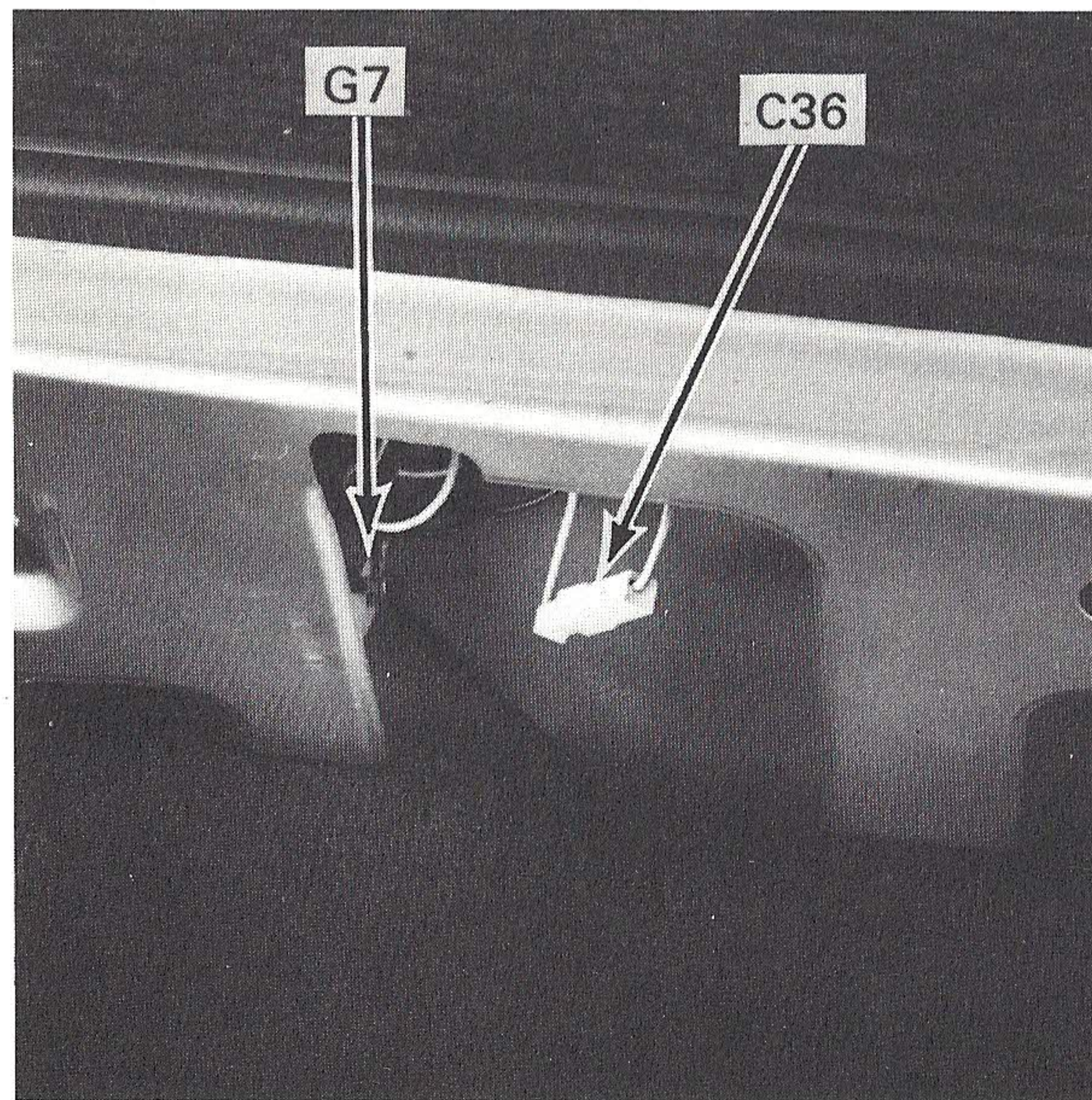
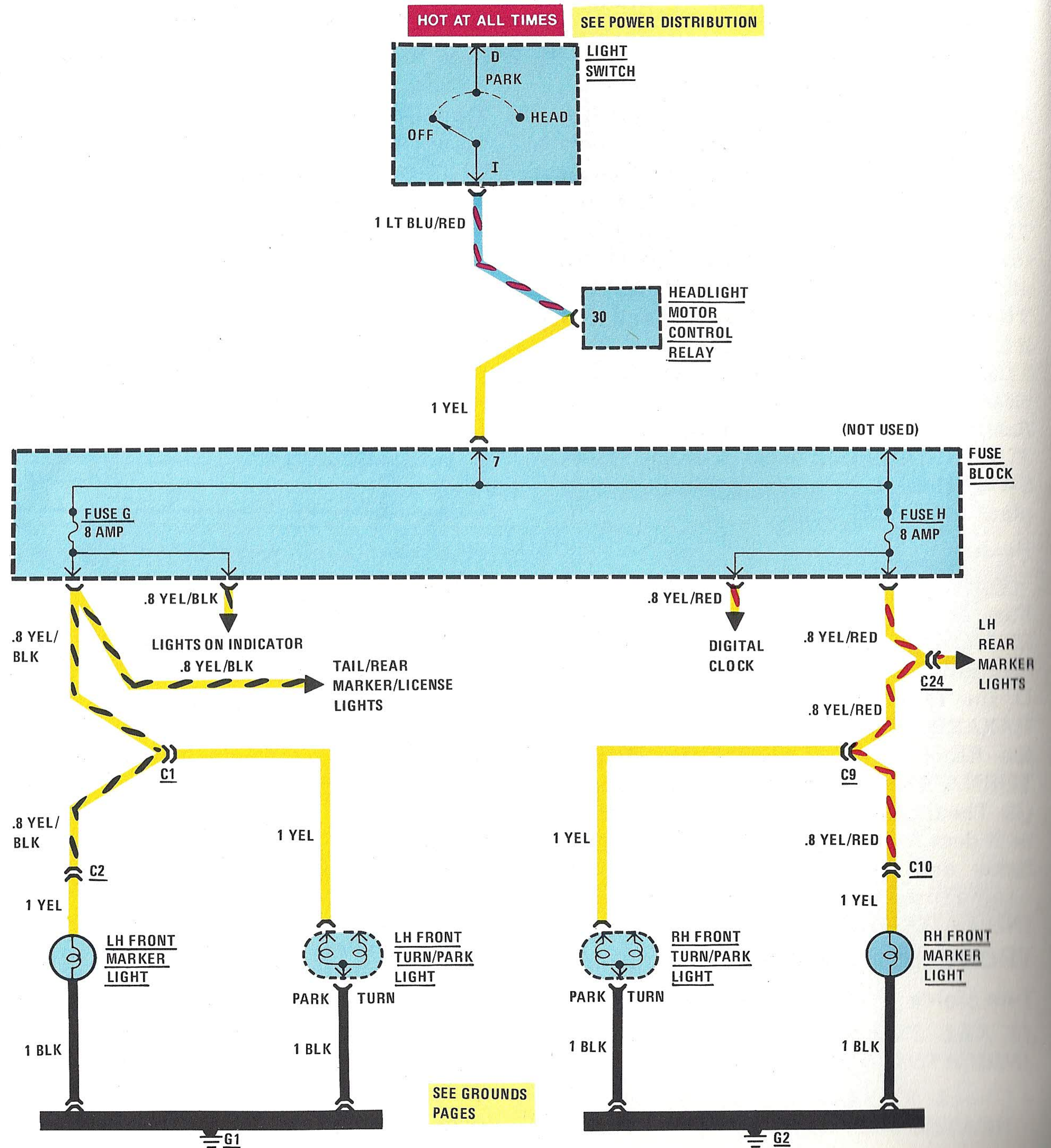

Figure 2 - Behind RH License Plate Assembly (LH Similar)



CIRCUIT OPERATION

Voltage is applied to the "Park" position of the LIGHT SWITCH at all times. With the switch in "Park," current flows through FUSES G and H, each FRONT MARKER and FRONT TURN/PARK LIGHT to G1 and G2.

Voltage is applied to the "Head" position of the LIGHT SWITCH only when the IGNITION SWITCH is in "Start" or "Run." This means that the lights will not go on with the LIGHT SWITCH in "Head" unless the IGNITION SWITCH is in "Start" or "Run."

TROUBLESHOOTING

IF FRONT MARKER OR FRONT PARK LIGHTS DON'T GO ON IN "PARK":

- Check continuity of LIGHT SWITCH by observing LIGHTS-ON INDICATOR.

IF FRONT MARKER OR PARK LIGHTS DON'T GO ON IN "HEAD":

- Check continuity of LIGHT SWITCH (headlights go on).

IF ONLY THE TURN PORTION OF A TURN/PARK LIGHT WORKS:

- Check the bulb.

COMPONENT LOCATION

| COMPONENT LOCATION | | Page-Figure |
|------------------------------|---|-------------|
| Fuse Block | Attached to top rear of relay panel | 64-1, 6-1 |
| Headlights Motor Relay | Attached to relay panel | 64-1 |
| C1 (2 cavities) | Behind LH headlight | 33-1 |
| C2 (1 cavity) | Behind LH headlight | 33-1 |
| C9 (2 cavities) | Behind LH headlight | 32-1 |
| C10 (1 cavity) | Behind LH headlight | 32-1 |
| C30 (1 cavity) | Below ignition coil | 15-1 |
| G1 | Behind LH headlight | 33-1 |
| G2 | Behind LH headlight | 32-1 |

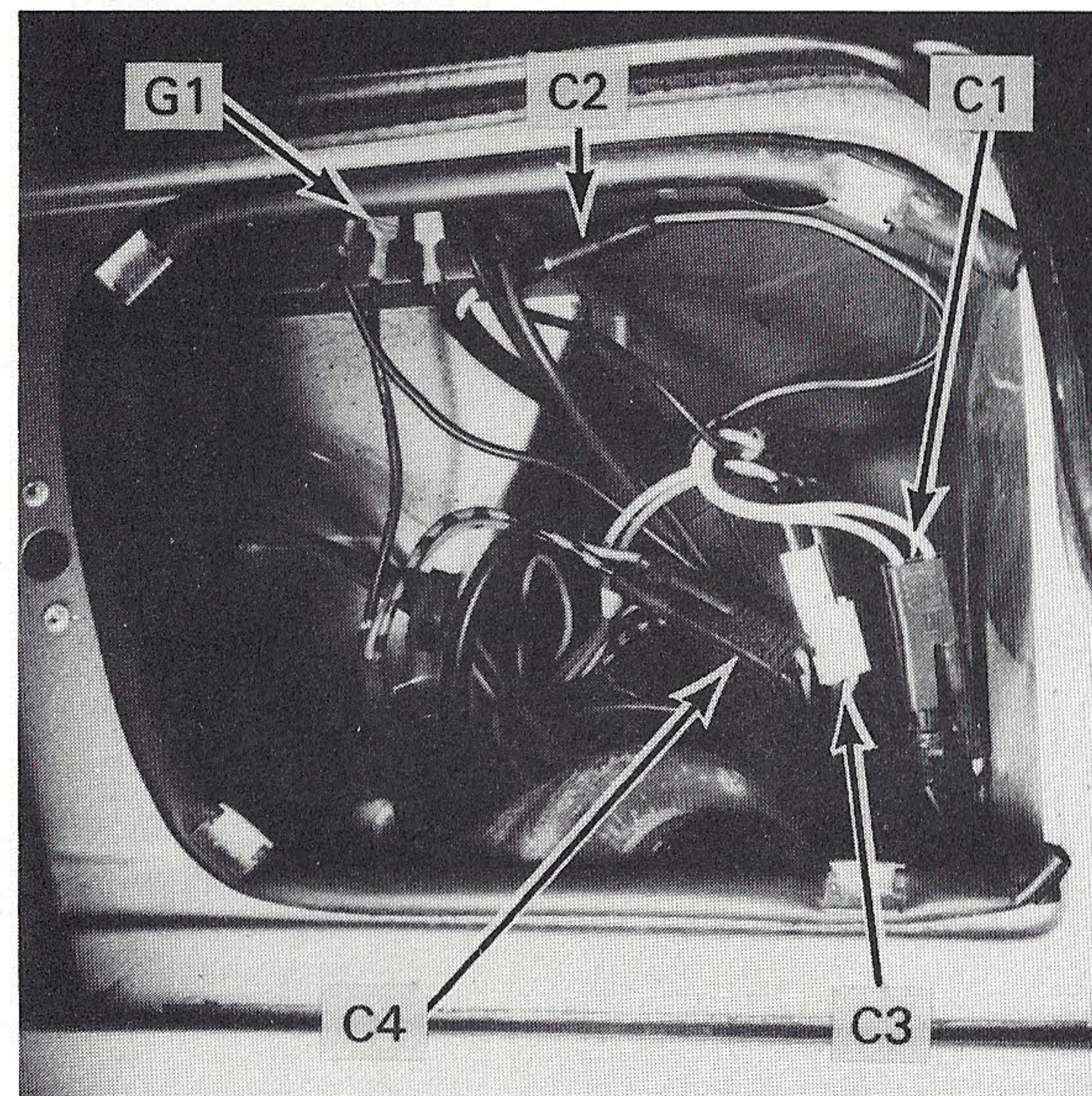

Figure 1 - Behind LH Headlight

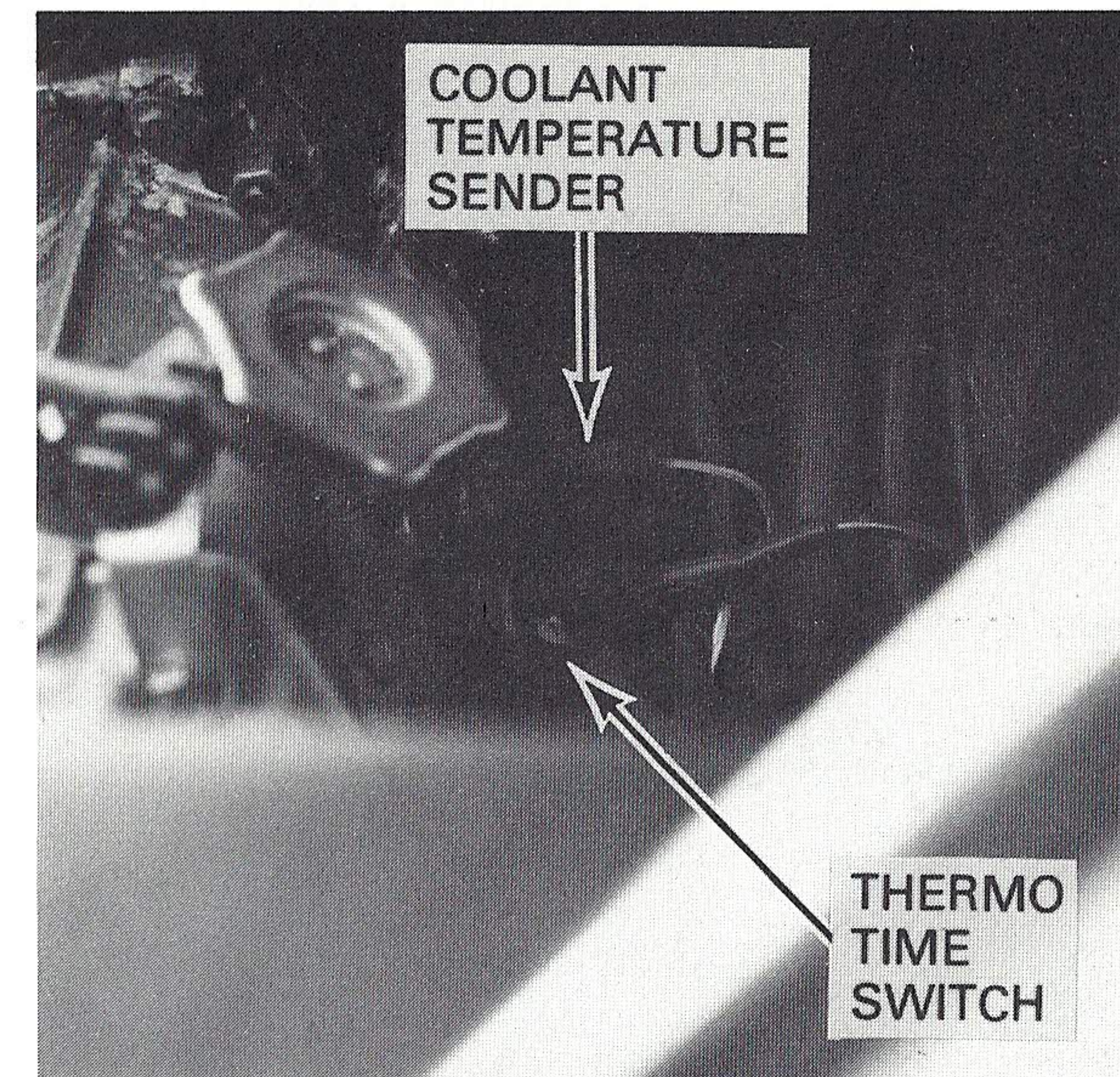
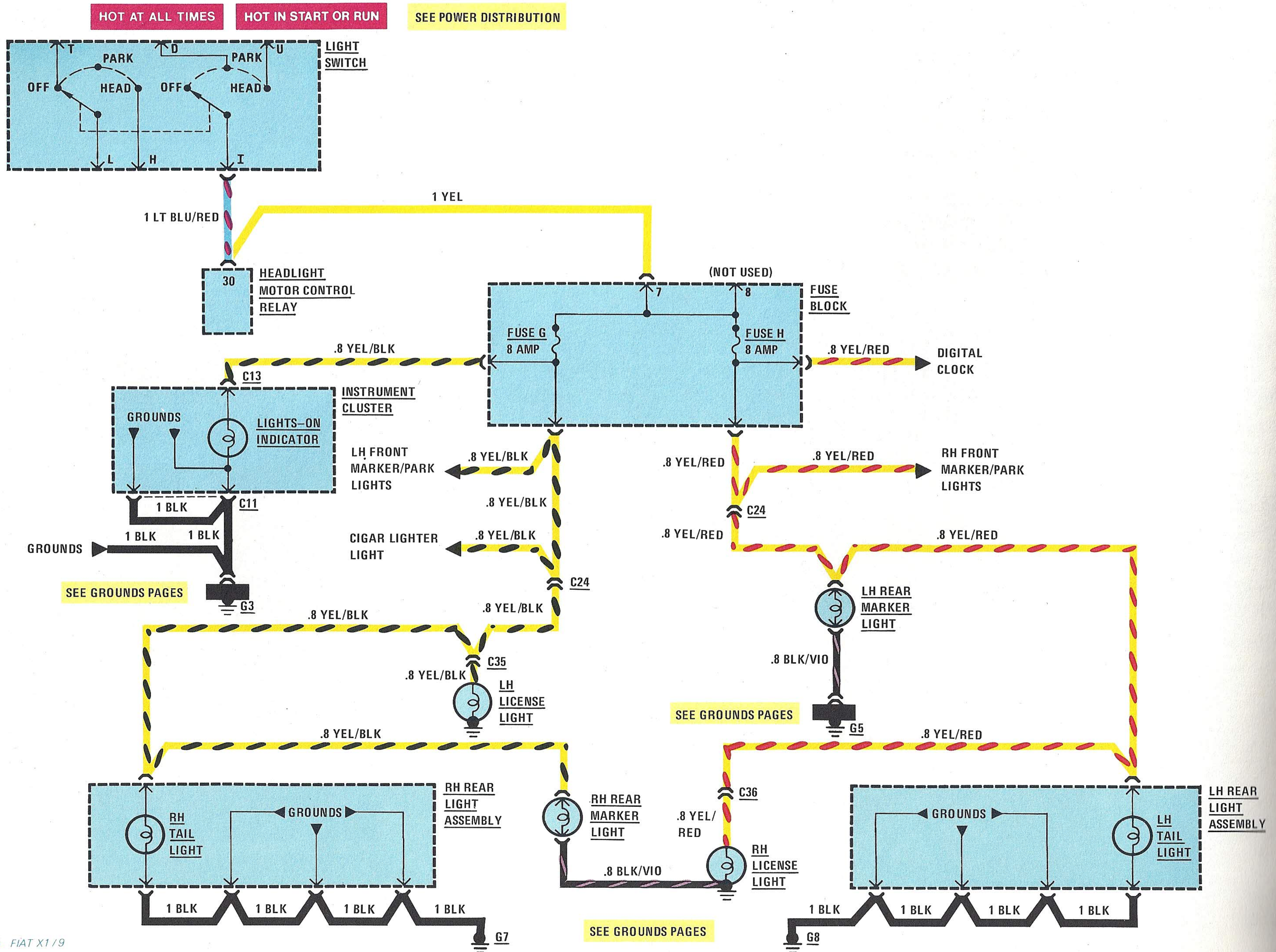

Figure 2 - Front Side of Engine

REAR MARKER/TAIL/LICENSE LIGHTS



CIRCUIT OPERATION

Voltage is applied to the "Park" position of the LIGHT SWITCH at all times. With the switch in "Park," current flows through FUSE G and LIGHTS-ON INDICATOR (to G3), and the LH LICENSE LIGHT (to case ground), the RH TAIL LIGHT (to G7), and the RH REAR MARKER LIGHT (to case ground at the RH LICENSE LIGHT). Current also flows through FUSE H, the LH REAR MARKER LIGHT (to G5), the LH TAIL LIGHT (to G8), and the RH LICENSE LIGHT (to case ground).

Voltage is applied to the "Head" position of the LIGHT SWITCH only when the IGNITION SWITCH is in "Start" or "Run." This means that the lights will not go on or stay on with the LIGHT SWITCH in "Head" unless the IGNITION SWITCH is in "Start" or "Run."

TROUBLESHOOTING

IF LIGHTS-ON INDICATOR DOESN'T GO ON:

- Check that G3 is clean and tight.
- Check that FUSE BLOCK connectors are tight.

IF ALL SIX LIGHTS AND INDICATOR DON'T GO ON:

- Check continuity of LIGHT SWITCH by operating FRONT MARKER LIGHTS.

IF INDICATOR GOES ON BUT ONE OR MORE REAR LIGHTS DO NOT:

- Check FUSE H.
- Check that connectors and ground are tight.

COMPONENT LOCATION

| | | Page-Figure |
|------------------------------|--|-------------|
| Fuse Block | Attached to top rear of relay panel | 64-1, 6-1 |
| Headlights Motor Relay | Attached to relay panel | 64-1 |
| Light Switch | LH side of dash panel | 41-1 |
| C11 (12 cavities) | Connected to LH rear of instrument cluster . | 27-2 |
| C13 (11 cavities) | Connected to center rear of instrument cluster | 27-2 |
| C24 (5 cavities) | Above relay panel | 35-1 |
| C35 (3 cavities) | Behind LH license plate light | 35-2 |
| C36 (7 cavities) | Behind RH license plate light | 32-2 |
| G3 | Under dash panel, to left of steering column | |
| G5 | To left of engine, attached to engine compartment wall | 39-3 |
| G7 | Attached behind RH license plate light | 32-2 |
| G8 | Attached behind LH license plate light | 35-2 |

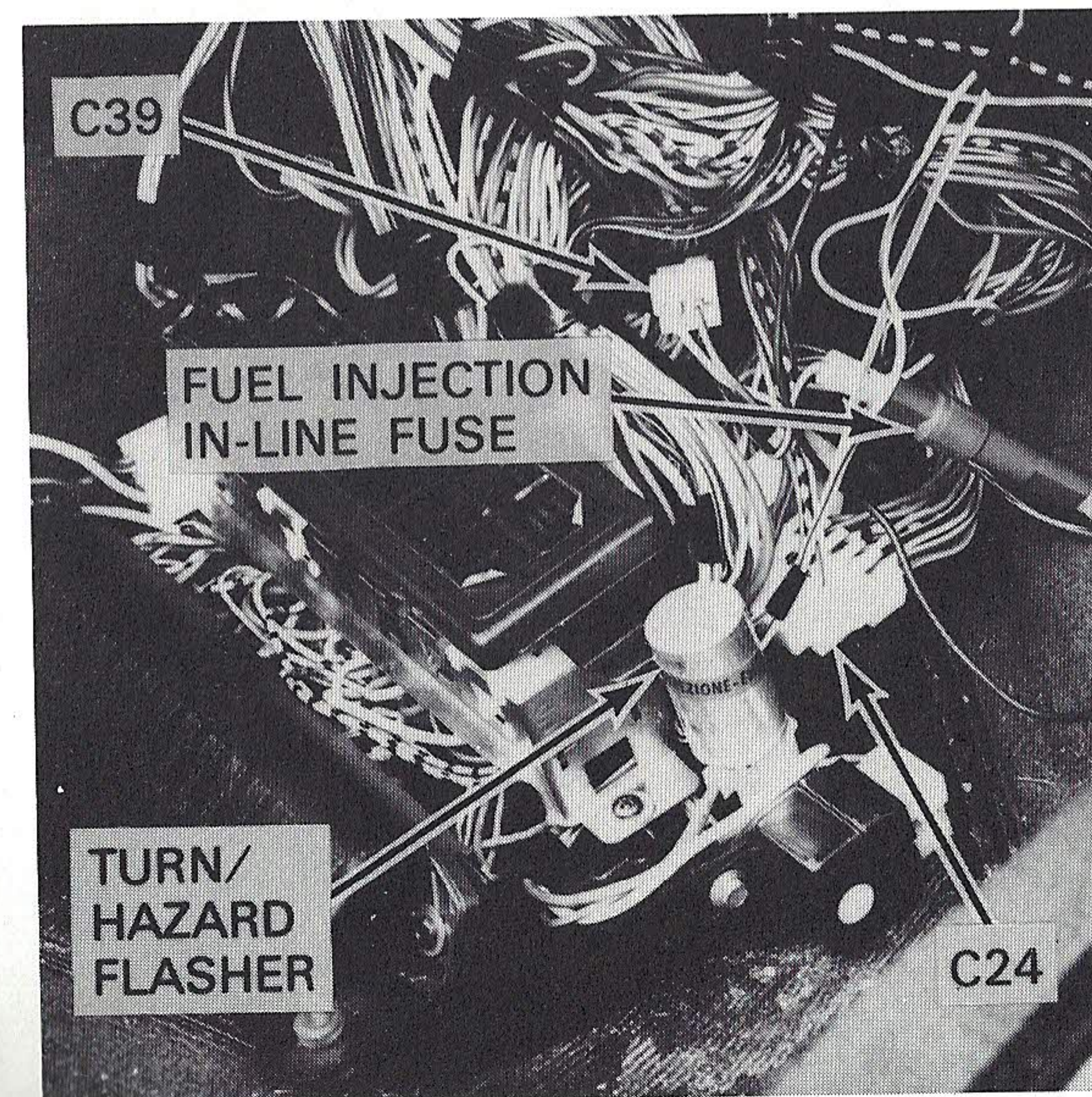

Figure 1 - Top RH Side of Relay Panel

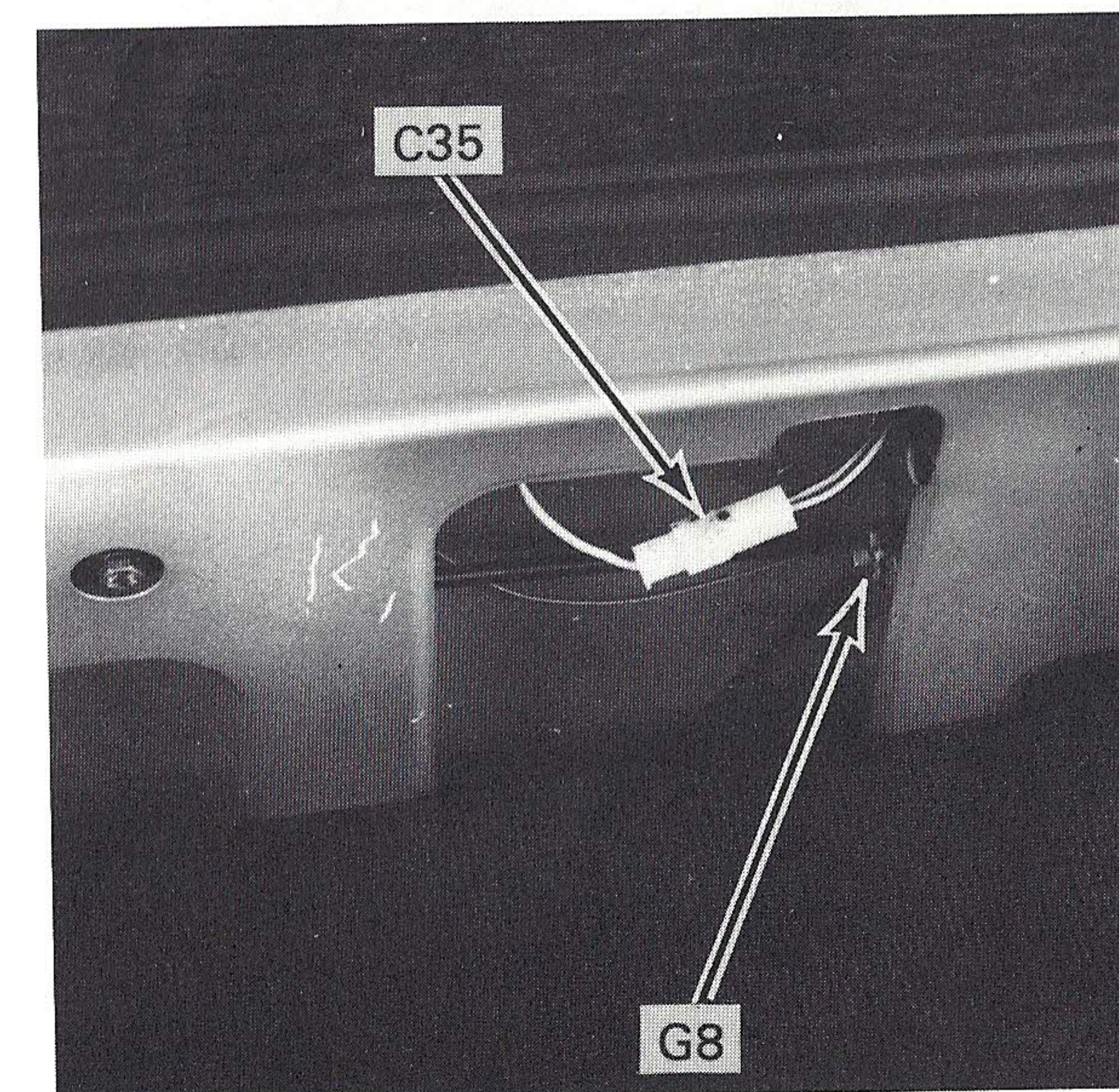
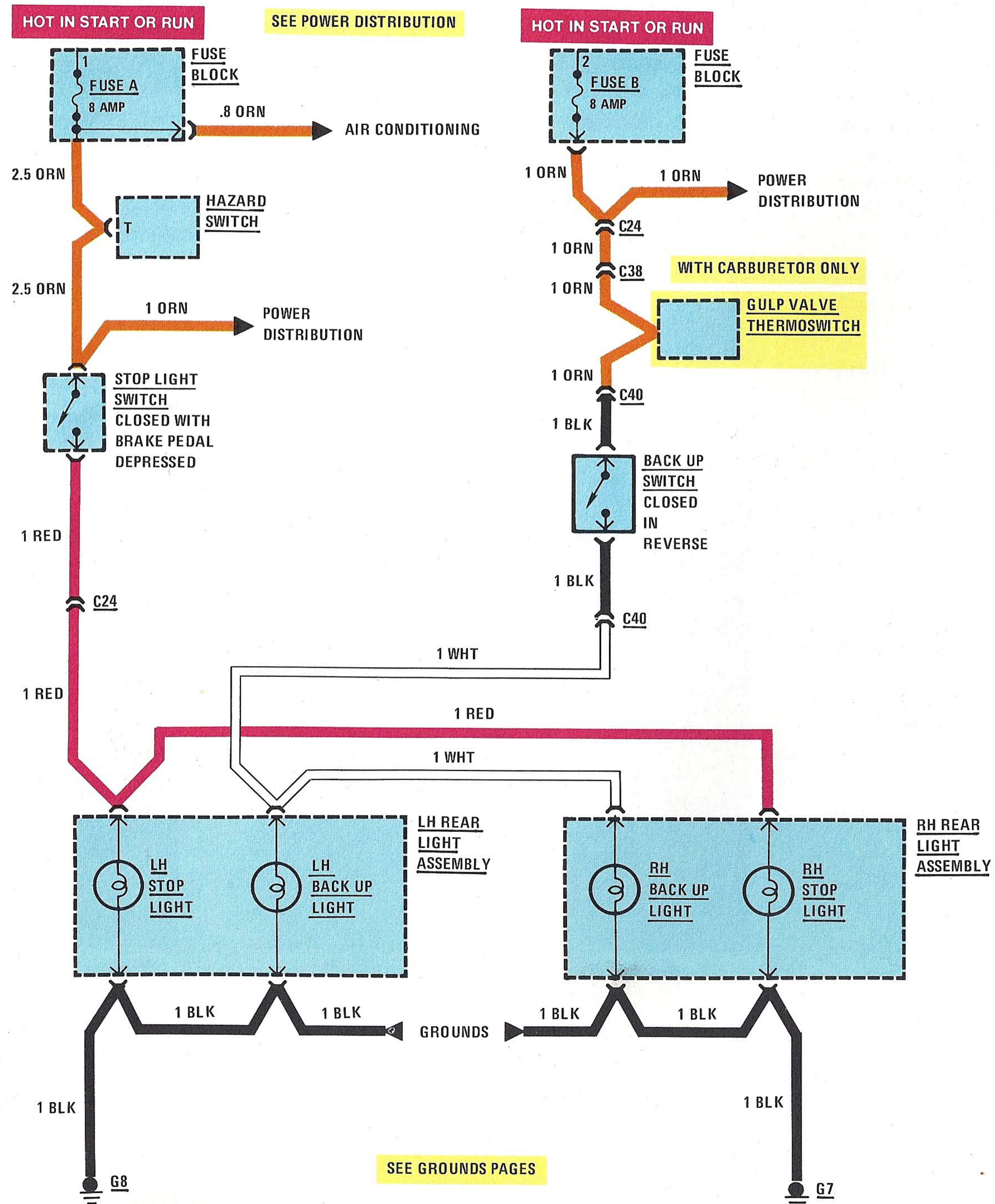

Figure 2 - Behind LH License Plate Light

BACK UP/STOP LIGHTS



CIRCUIT OPERATIONS

With the IGNITION SWITCH in "Run" or "Start," voltage is applied through FUSE A to the STOP LIGHT SWITCH. With the brake pedal depressed, the switch closes. Current flows through the STOP LIGHTS to G8 and G7. In "Start" or Run," voltage is also applied through FUSE B to the BACK UP SWITCH. When the transmission is shifted to "Reverse," the BACK UP SWITCH closes and current flows through the BACK UP LIGHTS to G8 and G7.

TROUBLESHOOTING

IF BOTH STOP LIGHTS DO NOT GO ON:

- Check FUSE A by operating HEATER FAN.
- Check continuity of STOP LIGHT SWITCH.

IF BOTH BACK UP LIGHTS DO NOT GO ON:

- Check FUSE B by operating Windshield Wipers.
- Check continuity of BACK UP SWITCH.

IF BOTH LH LIGHTS DO NOT GO ON:

- Check that G8 is clean and tight.

IF BOTH RH LIGHTS DO NOT GO ON:

- Check that G7 is clean and tight.

COMPONENT LOCATION

| | | Page-Figure |
|-------------------------|--|-------------|
| Back Up Switch | Connected to front of transmission | |
| Fuse Block | Attached to top rear of relay panel | 64-1 |
| Hazard Switch | Upper part of center console | 41-1 |
| Stop Light Switch..... | Attached to brake pedal support | 37-1 |
| C24 (12 cavities) | Above relay panel | 35-1 |
| C38 (1 cavities) | Above relay panel | |
| C40 (2 cavities) | Front LH side of engine | 37-2 |
| G7..... | Attached behind RH license plate light | 32-2 |
| G8..... | Attached behind LH license plate light | 35-2 |

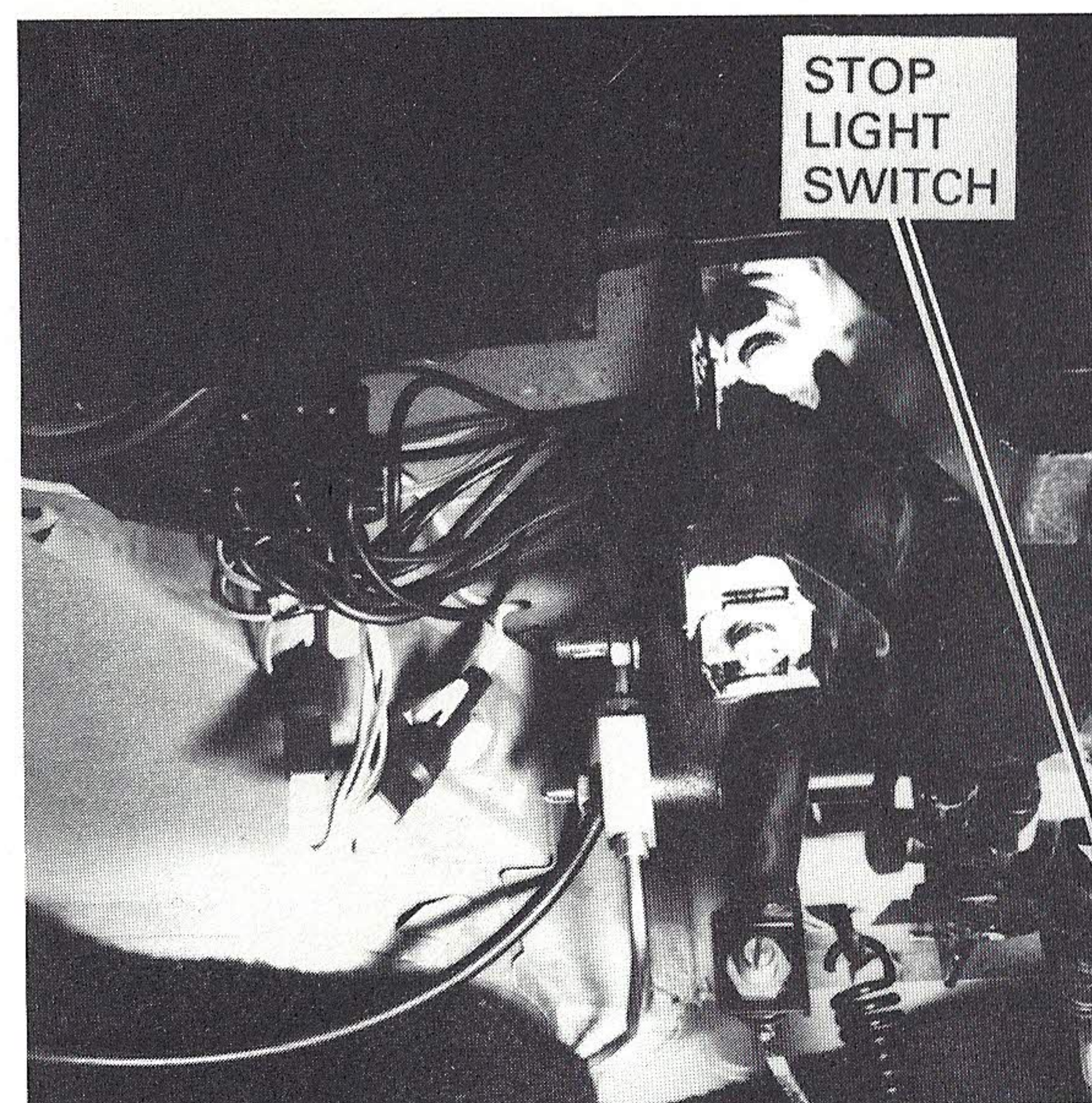

Figure 1 - Below LH Side of Dash Panel

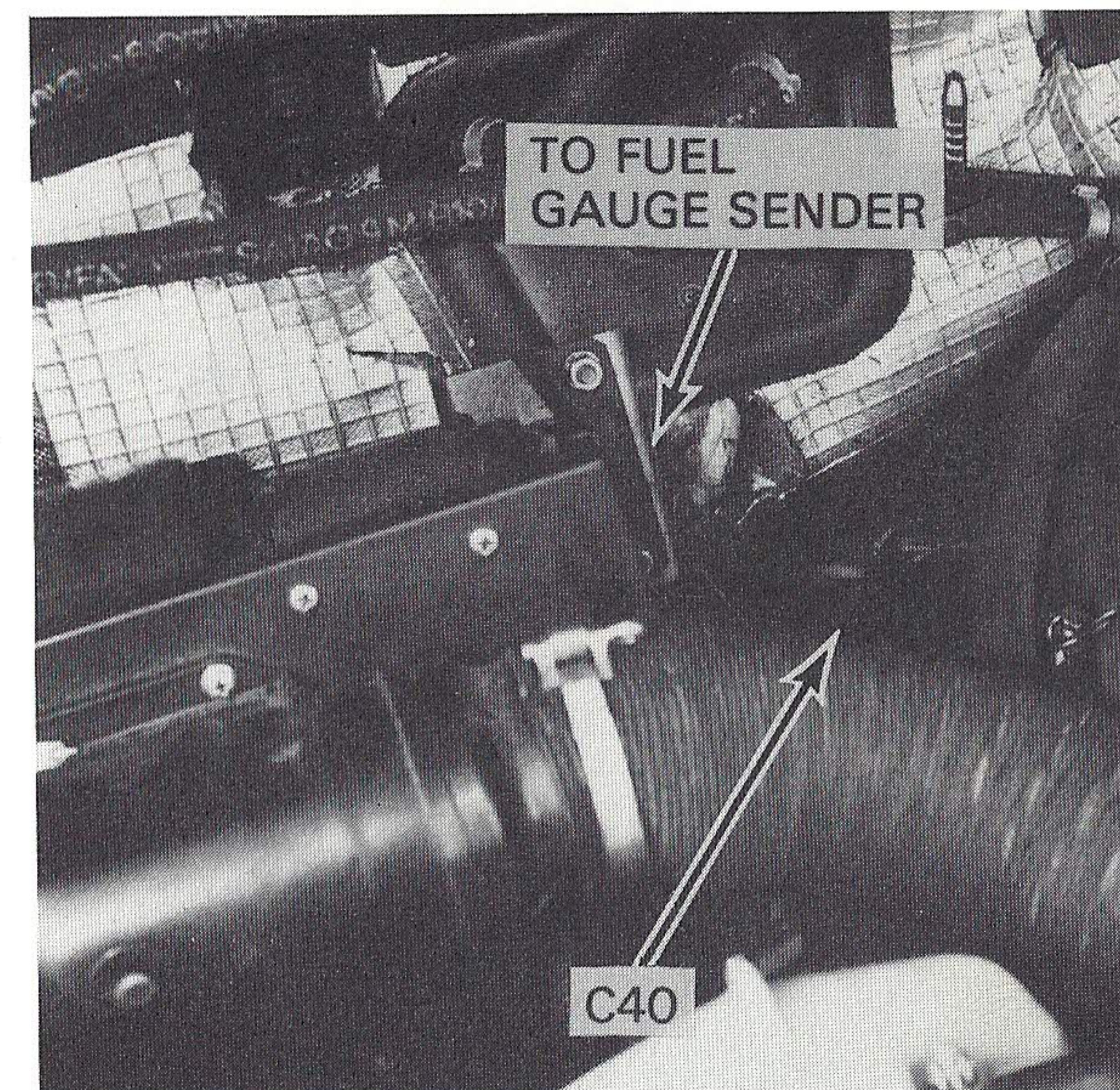
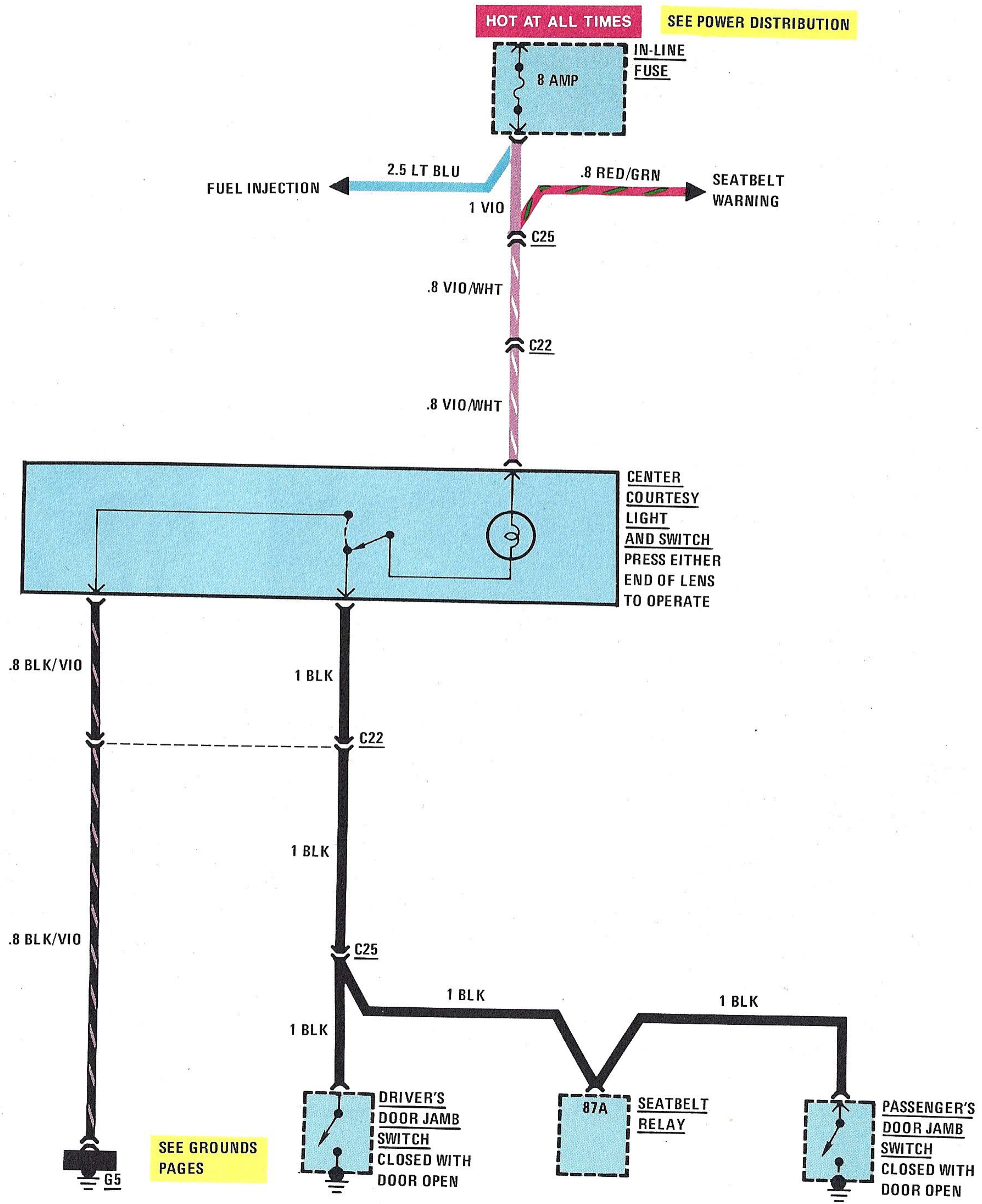

Figure 2 - Front LH Corner of Engine Compartment

COURTESY LIGHTS



CIRCUIT OPERATIONS

Voltage is applied at all times through the IN-LINE FUSE to the COURTESY LIGHT. The light includes a switch which grounds the bulb through G5, or the light can be operated through the LH or RH DOOR JAMB SWITCH.

TROUBLESHOOTING

IF CENTER COURTESY LIGHT DOES NOT WORK THROUGH ITS OWN SWITCH:

- Check IN-LINE FUSE.
- Check in-line connectors.
- Check G5.

IF LIGHT DOES NOT WORK THROUGH DOOR SWITCHES:

- Check case grounds.
- Check continuity of switches.



Figure 1 - RH Door Jamb (LH Similar)

COMPONENT LOCATION

| | | Page-Figure |
|---------------------------------------|--|-------------|
| Center Courtesy Light and Switch..... | Rear center section of roof | |
| Door Jamb Switches | In door jamb | 39-1 |
| In-Line Fuse | Above relay panel | 39-2 |
| Seatbelt Relay..... | Attached to relay panel | |
| C22 (3 cavities) | Behind rear mat, to left of spare tire | |
| C25 (12 cavities) | Above relay panel | 39-2 |
| G5..... | To left of engine, attached to engine compartment wall | 39-3 |

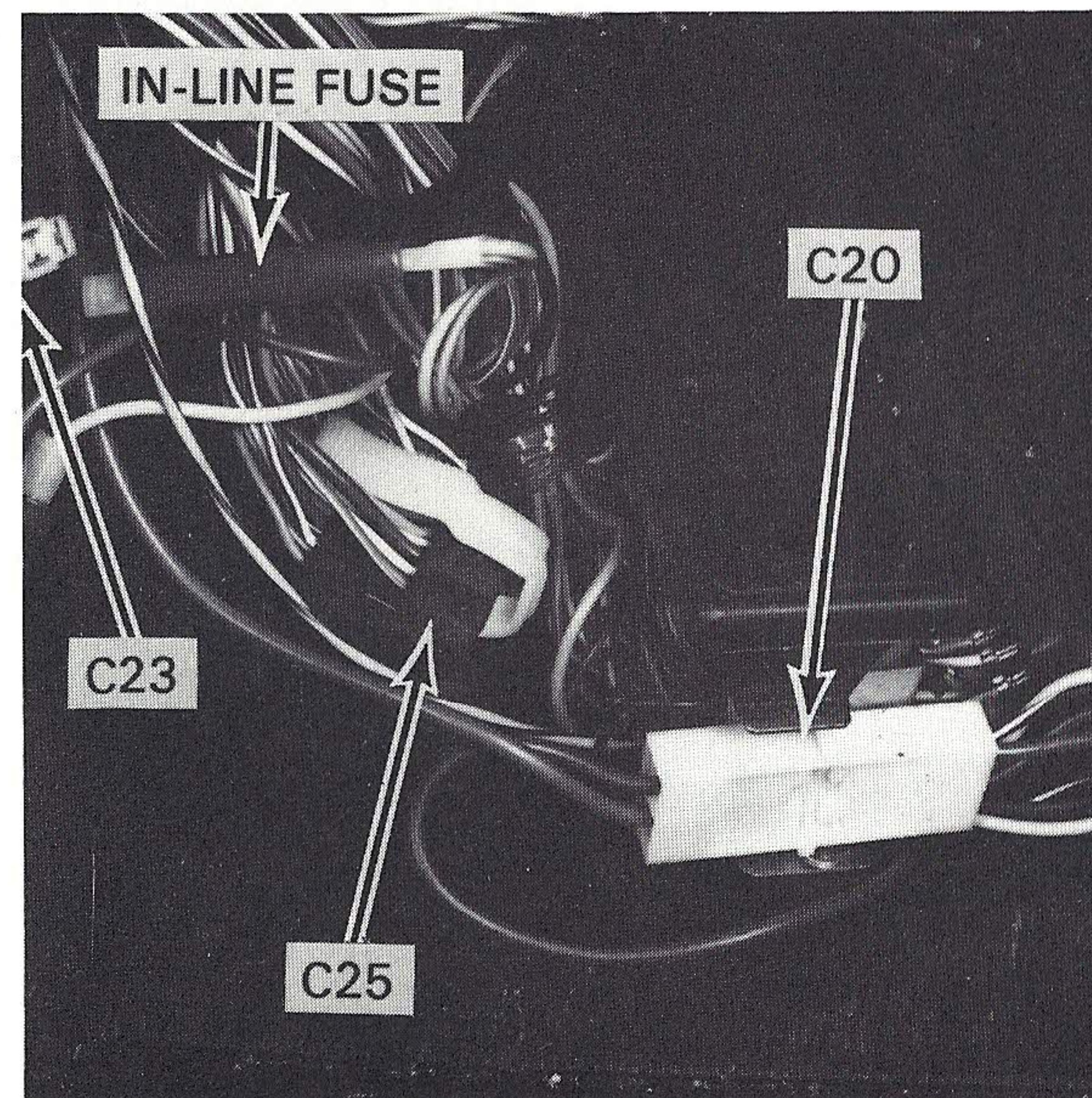

Figure 2 - LH Side of Relay Panel

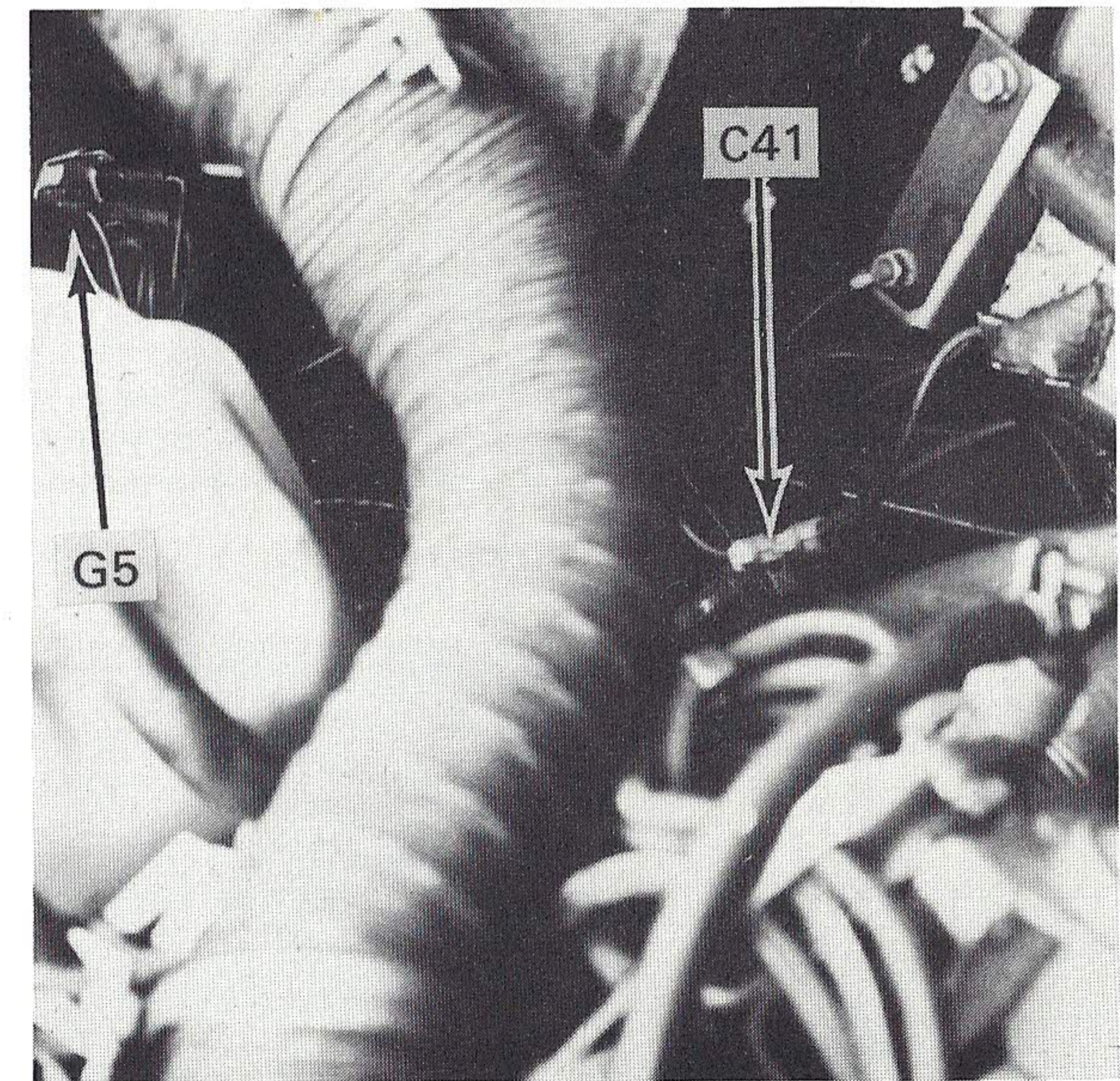
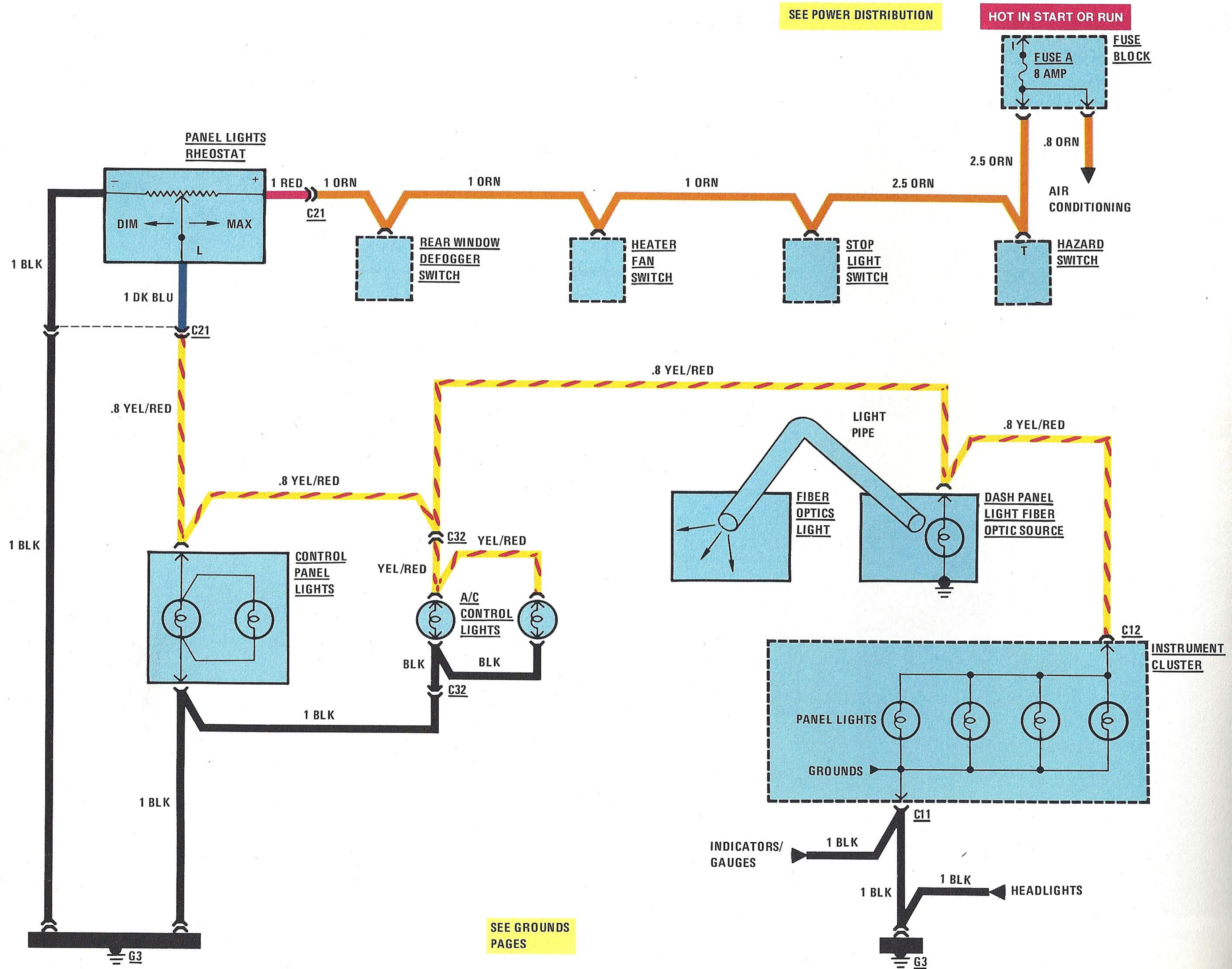

Figure 3 - LH Wall of Engine Compartment

DASH PANEL LIGHTS



CIRCUIT OPERATION

With the IGNITION SWITCH in "Start" or "Run," current flows through FUSE A, the PANEL LIGHTS RHEOSTAT, the CONTROL PANEL LIGHTS, A/C CONTROL LIGHTS and INSTRUMENT CLUSTER panel lights to G3. At the same time, current also flows through the DASH PANEL LIGHT FIBER OPTIC SOURCE to case ground. The rheostat allows the lights to be dimmed.

TROUBLESHOOTING

IF NO LIGHTS GO ON:

- Check FUSE A.
- Check continuity of PANEL LIGHTS RHEOSTAT.

IF ONLY DASH PANEL LIGHT FIBER OPTIC SOURCE GOES ON:

- Check that G3 is clean and tight.

COMPONENT LOCATION

Page-Figure

| | | |
|------------------------|--|------|
| Dash Panel Light Fiber | | |
| Optic Source | Attached behind center console..... | 55-2 |
| Fuse Block | Attached to top rear of relay panel..... | 64-1 |
| Hazard Switch | Upper portion of center console | 41-1 |
| Heater Fan Switch..... | Upper LH corner of center of dash panel.... | 41-1 |
| Rear Window Defogger | | |
| Switch..... | Upper portion of center console | 41-1 |
| Stop Light Switch..... | Attached to brake pedal support | 37-1 |
| C11 (5 cavities) | Connected to LH rear of instrument cluster . | 27-2 |
| C12 (6 cavities) | Connected to LH rear of instrument cluster . | 27-2 |
| C32 (2 cavities) | Behind radio..... | 59-2 |
| G3..... | Under dash panel, to left of steering column | |

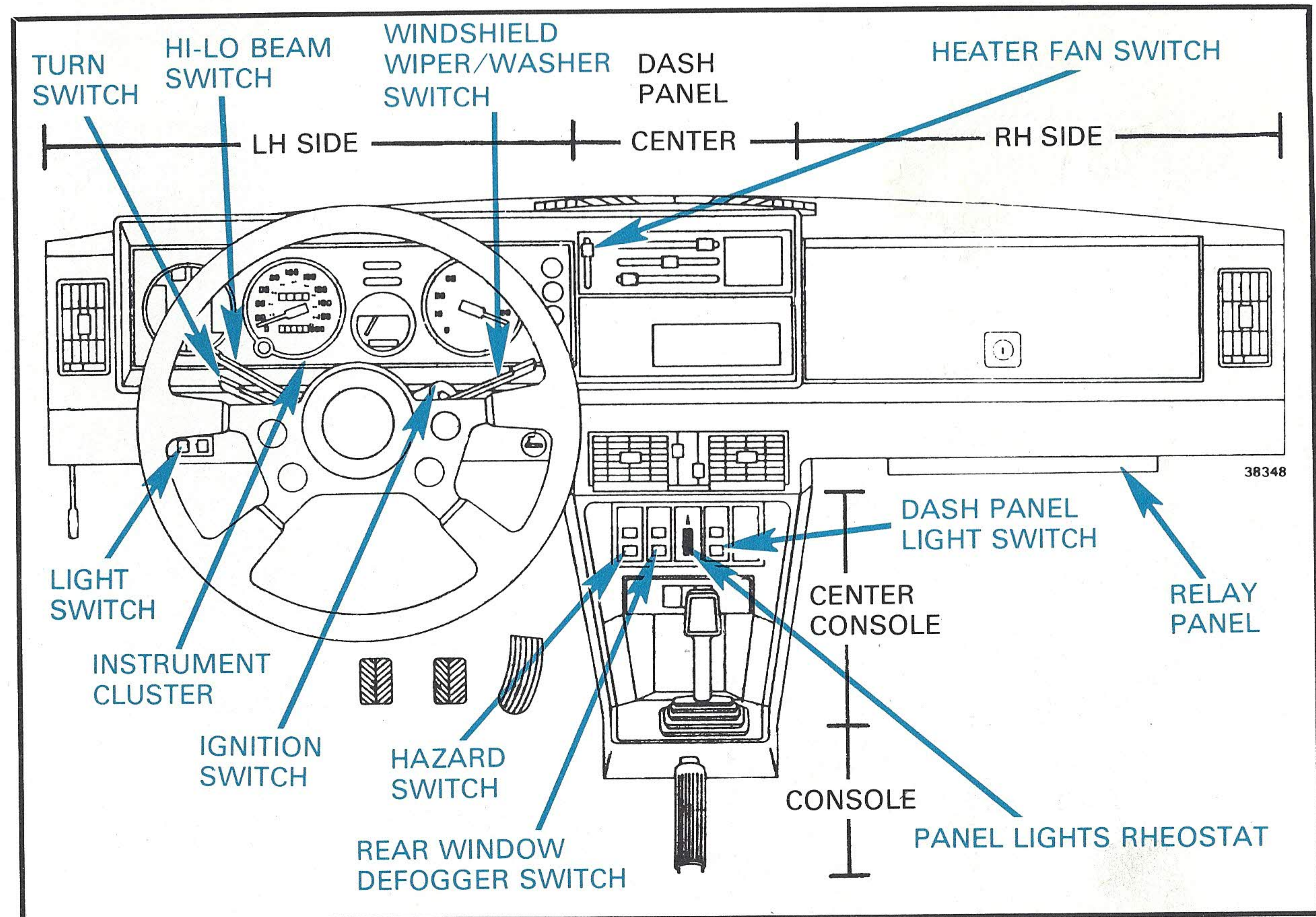
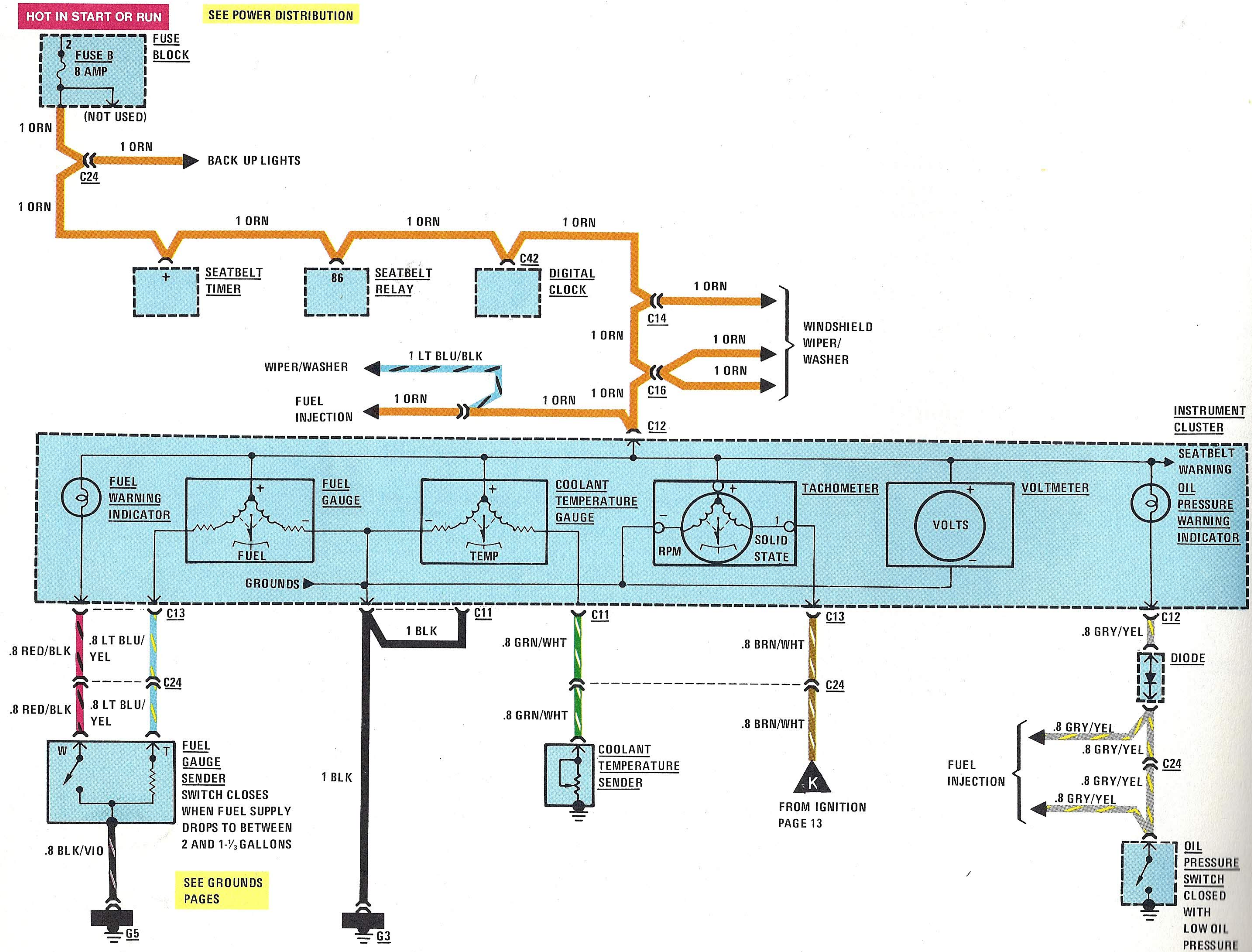

Figure 1 - Dash Panel Locations

INDICATORS/GAUGES



CIRCUIT OPERATION

Gauges

With the IGNITION SWITCH in "Start" or "Run," current flows through FUSE B, the FUEL GAUGE, COOLANT TEMPERATURE GAUGE, TACHOMETER, and the VOLTMETER. The gauges each include two magnetic coils which pull on a pointer in opposite directions. The balancing effect of the two coils prevents errors that would result from varying car voltage. In each gauge, current through one coil also flows through a sender. The sender controls the pointer by changing the amount of current flowing through that coil.

In the solid state TACHOMETER, the IGNITION COIL primary pulses are changed to a varying voltage, which moves the pointer.

Indicators

With the IGNITION SWITCH in "Start" or "Run," voltage is applied to the FUEL WARNING and OIL PRESSURE WARNING INDICATORS. Voltage is applied through the FUEL WARNING INDICATOR to terminal W of the FUEL GAUGE SENDER. When fuel is low, the switch inside the sender grounds the indicator and the bulb goes on. Voltage is applied through the OIL PRESSURE WARNING INDICATOR to the OIL PRESSURE SWITCH. When the switch closes, the INDICATOR bulb goes on.

TROUBLESHOOTING

IF FUEL GAUGE AND COOLANT TEMPERATURE GAUGE DON'T WORK:

• Check FUSE B by operating WINDSHIELD WIPERS.

COMPONENT LOCATION

Page-Figure

| | | |
|------------------------------|--|-----------|
| Coolant Temperature Sender.. | Front of engine, above starter motor | |
| Diode | Above relay panel | |
| Fuel Gauge Sender | Connected to top LH side of fuel tank..... | 43-1 |
| Fuse Block | Attached to top rear of relay panel | 64-1, 6-1 |
| Oil Pressure Switch | Lower front center of engine | |
| Seatbelt Relay | Attached to relay panel..... | 64-1 |
| Seatbelt Timer | Attached to relay panel..... | 64-1 |
| C11 (3 cavities) | Connected to LH rear of instrument cluster. | 57-1 |
| C12 (3 cavities) | Connected to LH rear of instrument cluster. | 57-1 |
| C13 (3 cavities) | Connected to center rear of instrument cluster | 57-1 |
| C14 (3 cavities) | Behind instrument cluster | 59-3 |
| C16 (3 cavities) | Behind instrument cluster | 47-1 |
| C24 (3 cavities) | Above relay panel | 35-1 |
| C42 (3 cavities) | Behind digital clock | 59-2 |
| G5 | To left of engine, attached to engine compartment wall | 39-3 |

IF ONE GAUGE DOESN'T WORK:

- Check its sender by disconnecting it. If its

pointer then goes to maximum, the sender is probably broken.

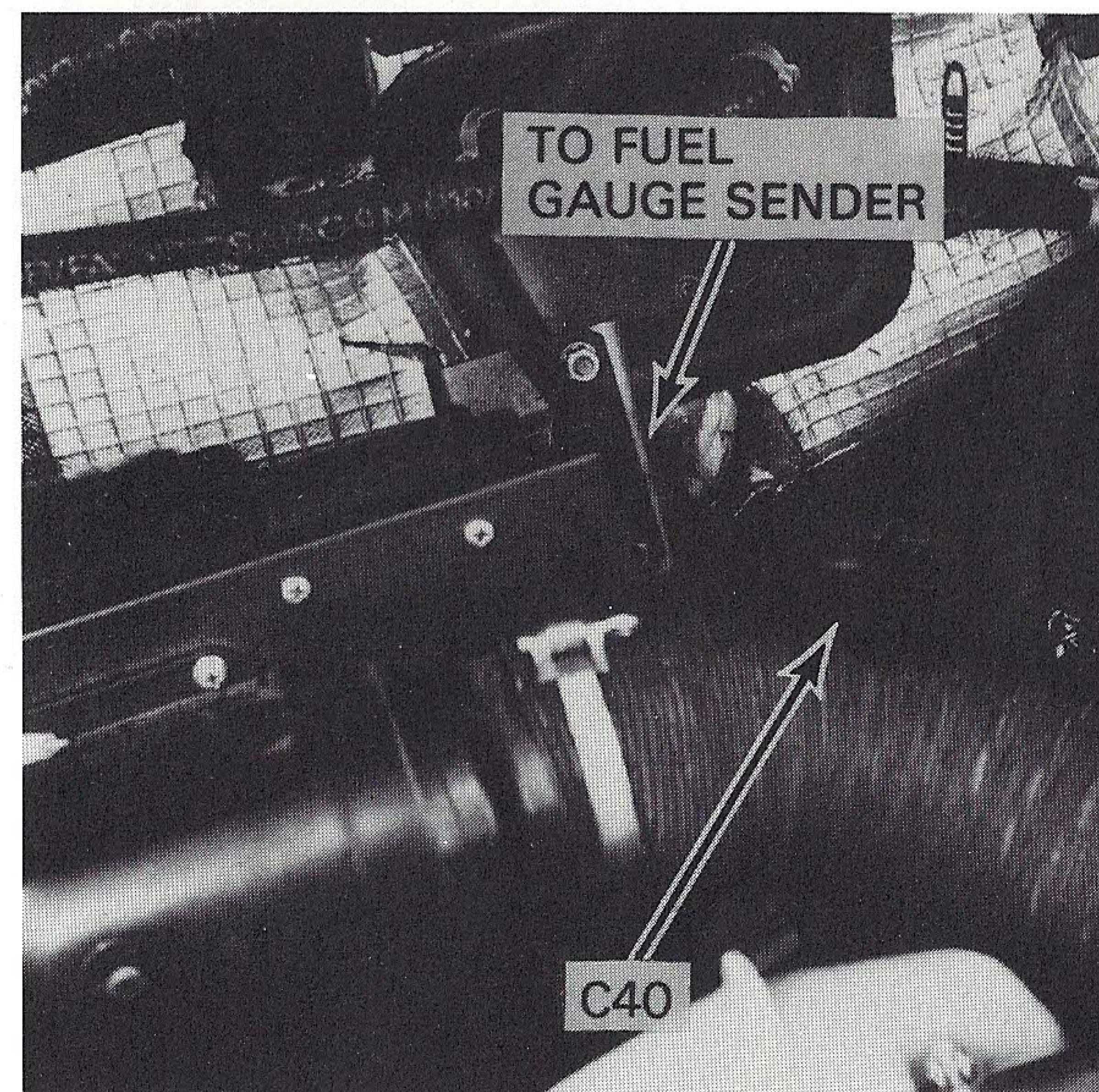

Figure 1 - Front LH Corner of Engine Compartment

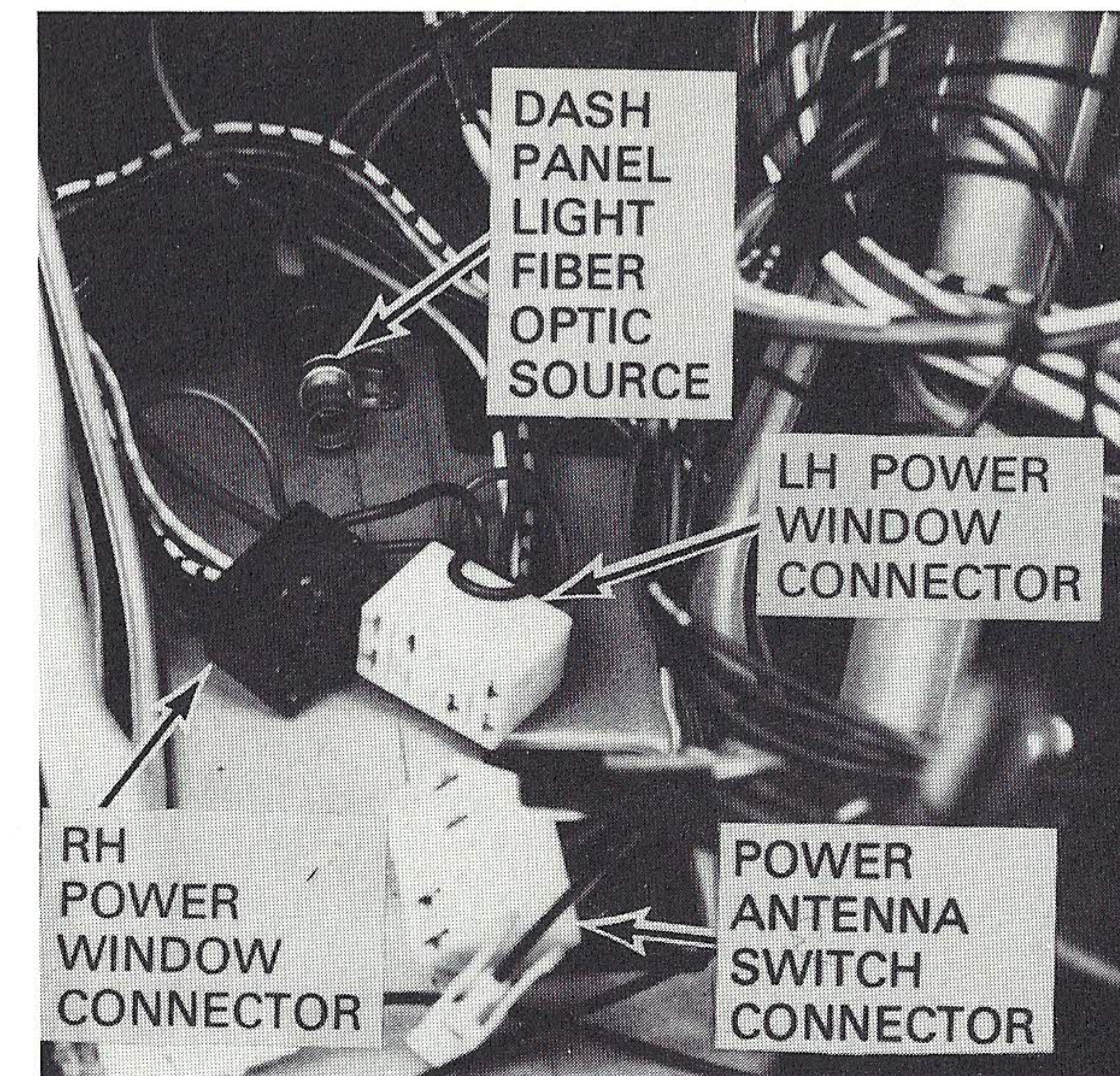

Figure 2 - Behind Center of Dash Panel

SEE POWER DISTRIBUTION

HOT AT ALL TIMES

HOT IN START OR RUN

SEE POWER DISTRIBUTION

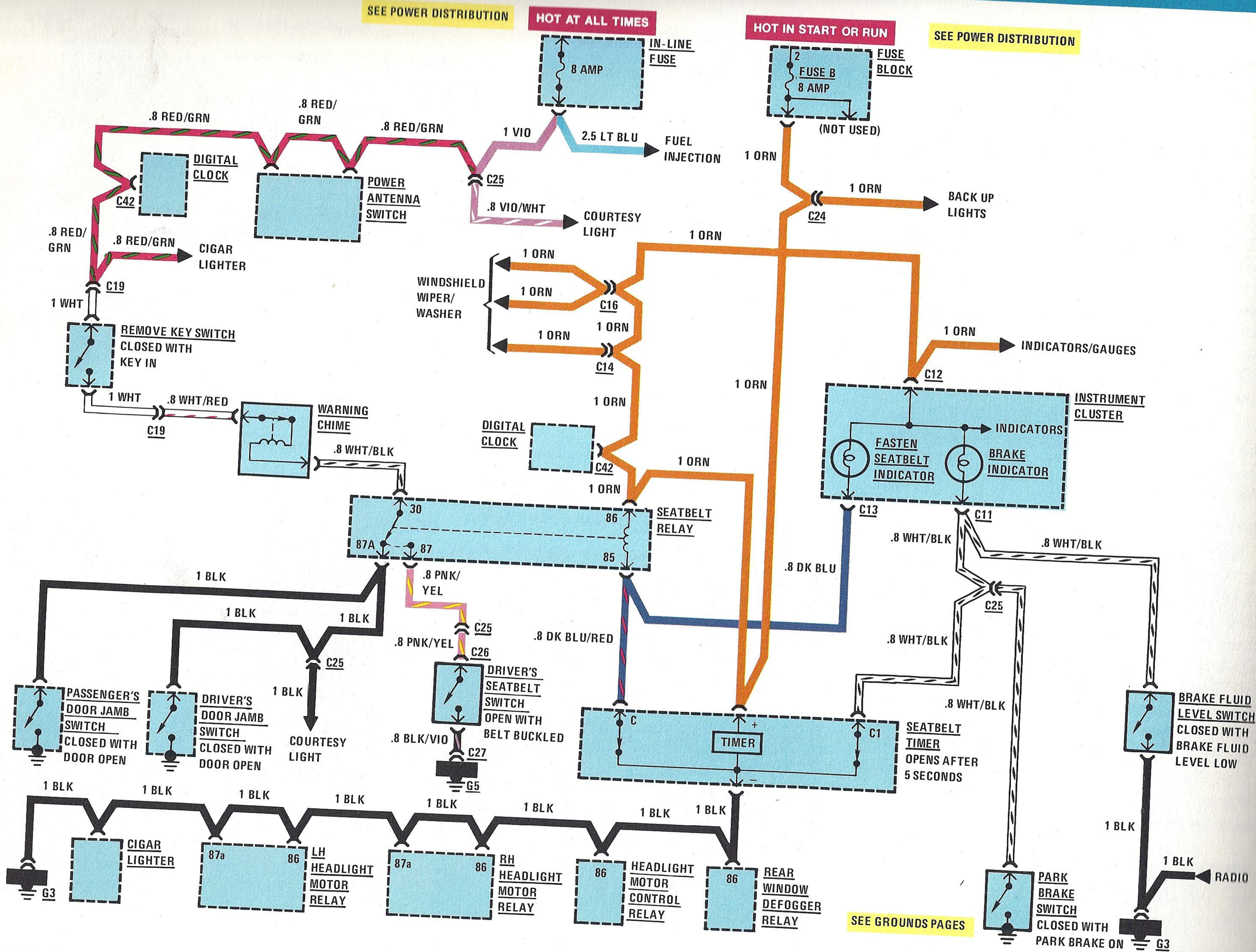

CIRCUIT OPERATION

Remove Key Warning

Voltage is applied at all times through the IN-LINE FUSE to the REMOVE KEY SWITCH. If the key is in the IGNITION SWITCH, the voltage is applied through the WARNING CHIME, terminals 30 and 87a of the SEATBELT RELAY, and the BLK wires to the DOOR JAMB SWITCHES. When either door is opened, its DOOR JAMB SWITCH closes. This grounds the circuit and the WARNING CHIME sounds.

Seatbelt Warning

When the IGNITION SWITCH is turned to "Start" or "Run," current follows three paths through FUSE B to ground: 1) to (but not through) the plus (+) terminal of the SEATBELT TIMER, to (but not through) terminal 86 of the SEATBELT RELAY, the ORN wire, through the FASTEN SEATBELT INDICATOR, the DK BLU wire, to (but not through) terminal 85 of the SEATBELT RELAY, the DK BLU/RED wire, through the SEATBELT TIMER, and to ground (G3); 2) through the plus (+) terminal of the SEATBELT TIMER to G3; and 3) to (but not through) the plus (+) terminal of the SEATBELT TIMER, the ORN wire, through the SEATBELT RELAY coil, DK BLU/RED wire and SEATBELT TIMER to ground. The first path lights the indicator. The second path operates the timer and opens the other two paths after about five seconds. The FASTEN SEATBELT INDICATOR will go off after 5 seconds regardless of the seatbelt switch. The third path operates the relay and pulls in the relay contacts. If the DRIVER'S SEATBELT SWITCH is closed, it grounds the WARNING CHIME. The

COMPONENT LOCATION

| | | Page-Figure |
|-------------------------------------|--|-------------|
| Brake Fluid Level Switch | Inside brake fluid reservoir..... | 46-1 |
| Door Jamb Switches | In door jambs | 39-1 |
| Driver's Seatbelt Switch..... | Part of driver's seatbelt assembly | 46-2 |
| Fuse Block | Attached to top rear of relay panel | 64-1, 6-1 |
| Headlight Motor Control Relay | Attached to relay panel..... | 64-1 |
| In-Line Fuse | Above relay panel | 47-2 |
| LH Headlight Motor Relay .. | Attached to relay panel..... | 64-1 |
| Park Brake Switch..... | Attached to base of handbrake assembly | 46-2 |
| Power Antenna Switch | Part of center console | 55-2 |
| Rear Window Defogger Relay | Attached to relay panel | 64-1 |
| Remove Key Switch | Part of ignition switch..... | 41-1 |
| RH Headlight Motor Relay .. | Attached to relay panel..... | 64-1 |
| Seatbelt Relay | Attached above relay panel | |
| Seatbelt Timer | Attached to relay panel..... | 64-1 |
| Warning Chime | Upper RH dash panel | |
| C11 (5 cavities) | Connected to LH rear of instrument cluster | 57-1 |
| C12 (6 cavities) | Connected to LH rear of instrument cluster . | 57-1 |
| C13 (8 cavities) | Connected to center rear of instrument cluster | 57-1 |
| C16 (8 cavities) | Behind instrument cluster | 47-1 |
| C19 (2 cavities) | Behind instrument cluster | 47-1 |
| C24 (12 cavities) | Above relay panel | 35-1 |
| C25 (12 cavities) | Above relay panel | 47-2 |
| C26 (1 cavity) | Behind driver's seat | 12-1 |
| C27 (1 cavity) | Behind driver's seat | 12-1 |
| C42 (4 cavities) | Behind digital clock | 59-2 |
| G3..... | Under dash panel, to left of steering column | |
| G5..... | To left of engine, attached to engine compartment wall | 39-3 |

WARNING CHIME sounds until the belt is buckled or the timer opens the current path.

CIGAR LIGHTER/CLOCK

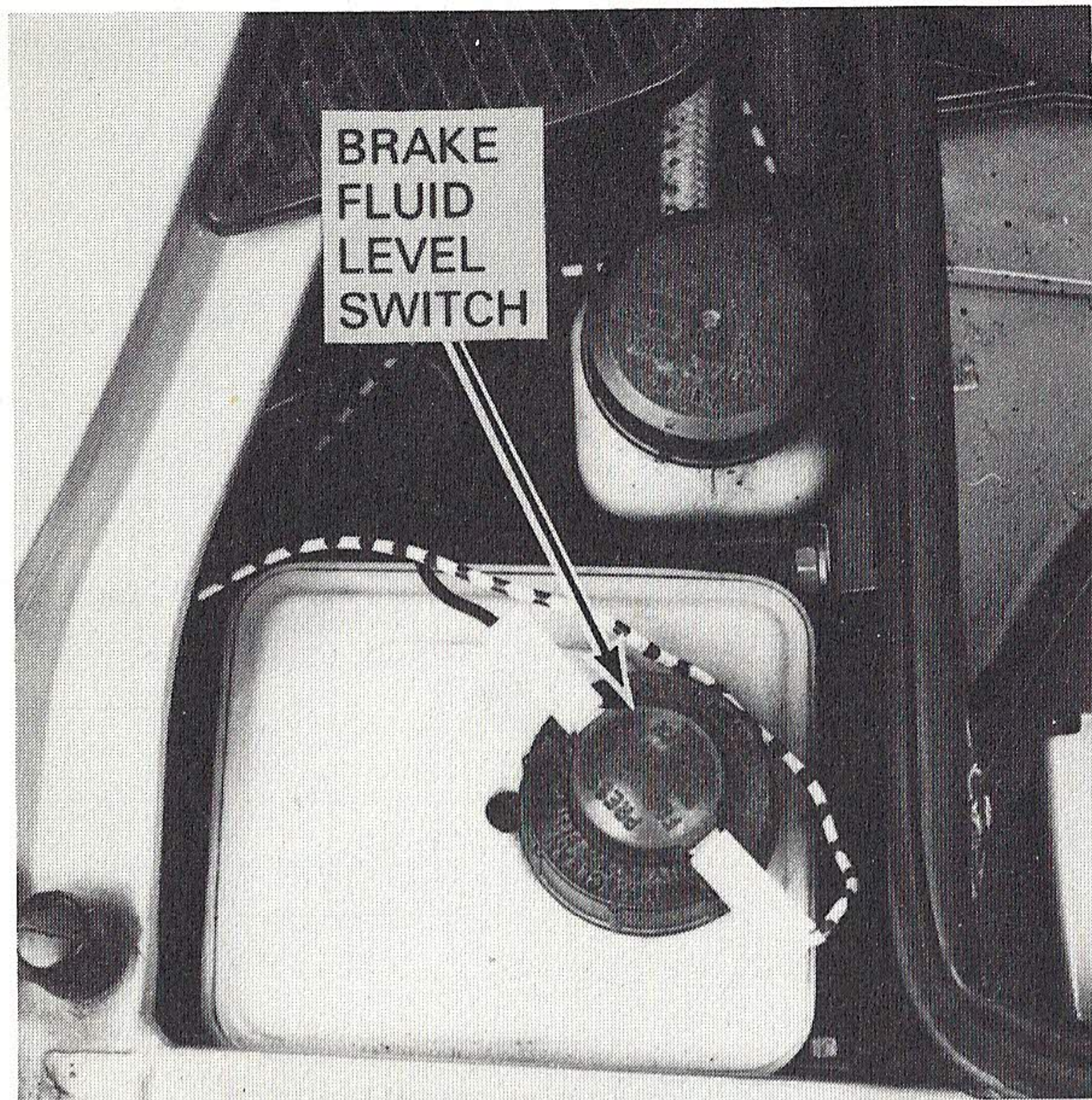

Figure 1 - RH Side of Cowl

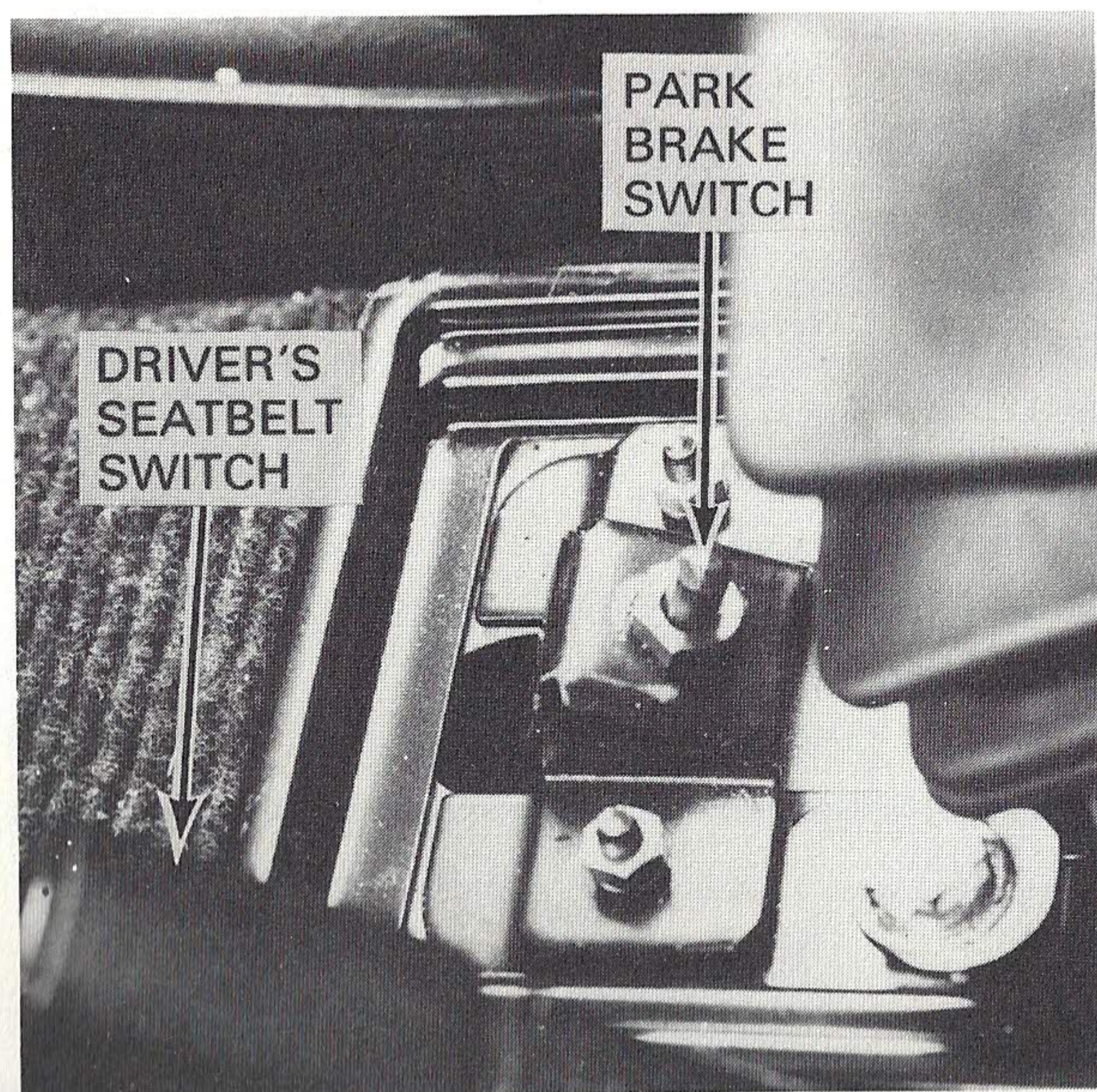
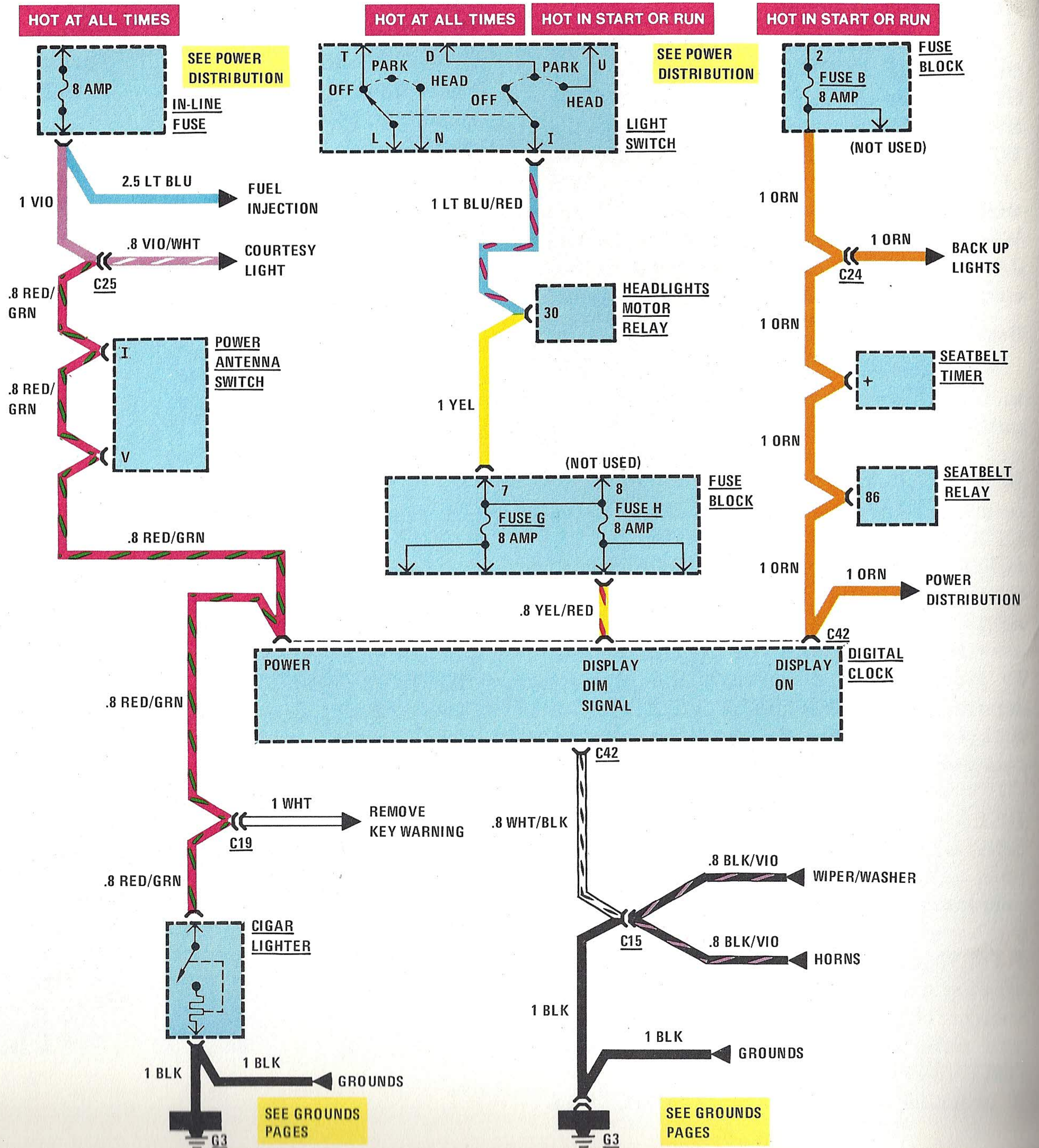

Figure 2 - Base of Park Brake



CIRCUIT OPERATION

Voltage is available at all times through the IN-LINE FUSE to the DIGITAL CLOCK and the CIGAR LIGHTER. When the CIGAR LIGHTER is operated, it is grounded through G3.

Current flows at all times through the IN-LINE FUSE, the power terminal of the DIGITAL CLOCK, and to ground. The clock operates, but does not display the time. With the IGNITION SWITCH in "Start" or "Run," current flows through FUSE B, the display-on terminal of the clock, and to ground. The clock displays the time. With the LIGHT SWITCH in "Park" or "Head," current flows through the LIGHT SWITCH, FUSE H, the display-dim-signal terminal, and to ground. The clock display dims.

TROUBLESHOOTING

IF CLOCK DOES NOT DISPLAY THE TIME WITH IGNITION SWITCH IN "START" OR "RUN":

- Check IN-LINE FUSE by operating CENTER COURTESY LIGHT.
- Check FUSE B by operating WINDSHIELD WIPERS.
- Check that G3 is clean and tight.

IF CLOCK RUNS BUT DISPLAY DOES NOT DIM WITH LIGHT SWITCH IN "PARK" OR "HEAD":

- Check FUSE H by observing RH FRONT MARKER/PARK LIGHTS.

COMPONENT LOCATION

| | | Page-Figure |
|------------------------------|--|-------------|
| Fuse Block | Attached to top rear of relay panel | 64-1, 6-1 |
| Headlights Motor Relay | Attached to relay panel | 64-1 |
| In Line Fuse | Above relay panel | 47-2 |
| Power Antenna Switch | Part of center console | 55-2 |
| Seatbelt Relay | Attached to relay panel | 64-1 |
| Seatbelt Timer | Attached to relay panel | 64-1 |
| C15 (5 cavities) | Behind instrument cluster | 47-1 |
| C19 (5 cavities) | Behind instrument cluster | 47-1 |
| C24 (5 cavities) | Above relay panel | 35-1 |
| C25 (5 cavities) | Above relay panel | 47-2 |
| C42 (5 cavities) | Behind digital clock | 59-2 |
| G3 | Under dash panel, to left of steering column | |

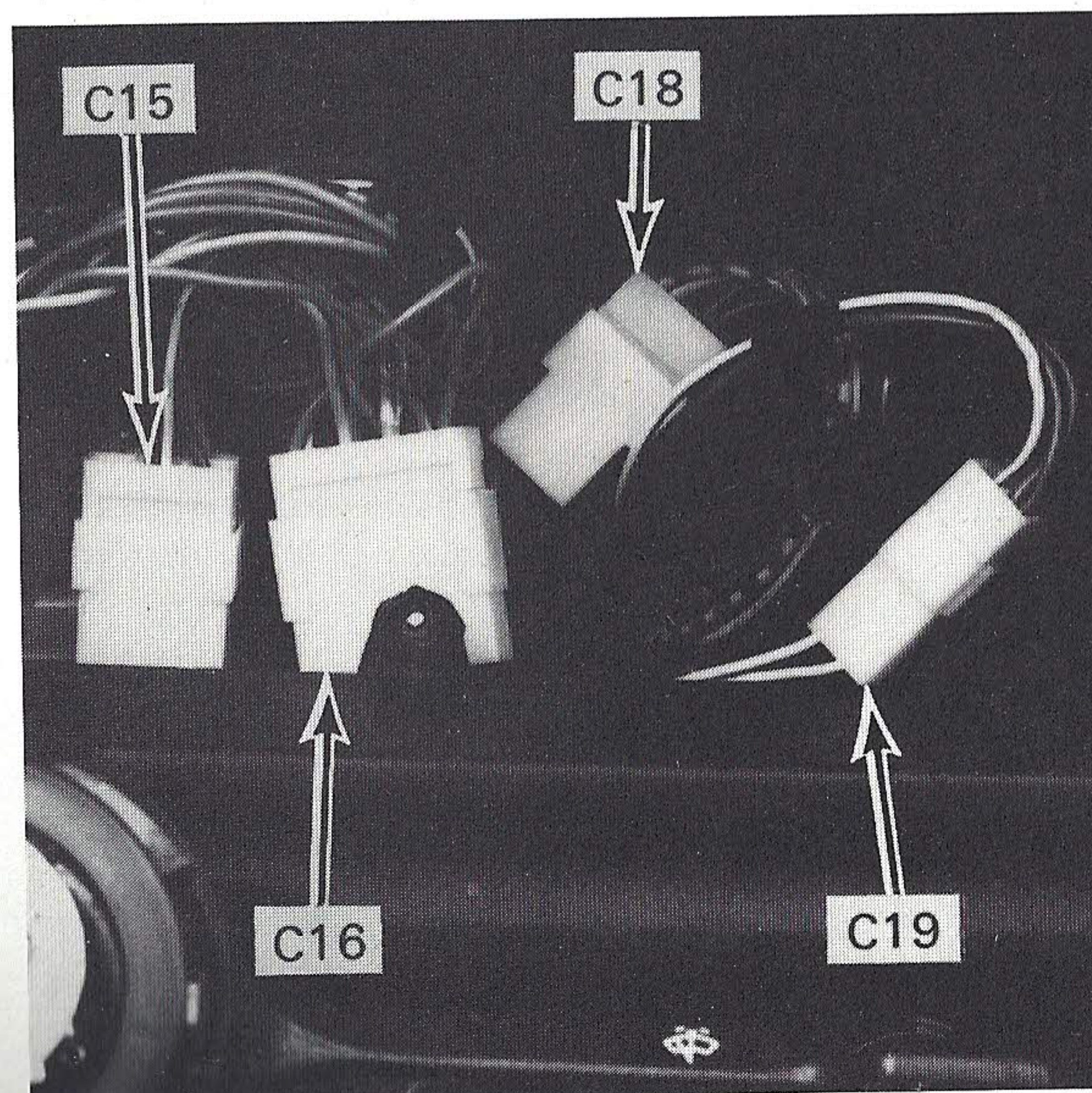

Figure 1 - Behind Instrument Cluster

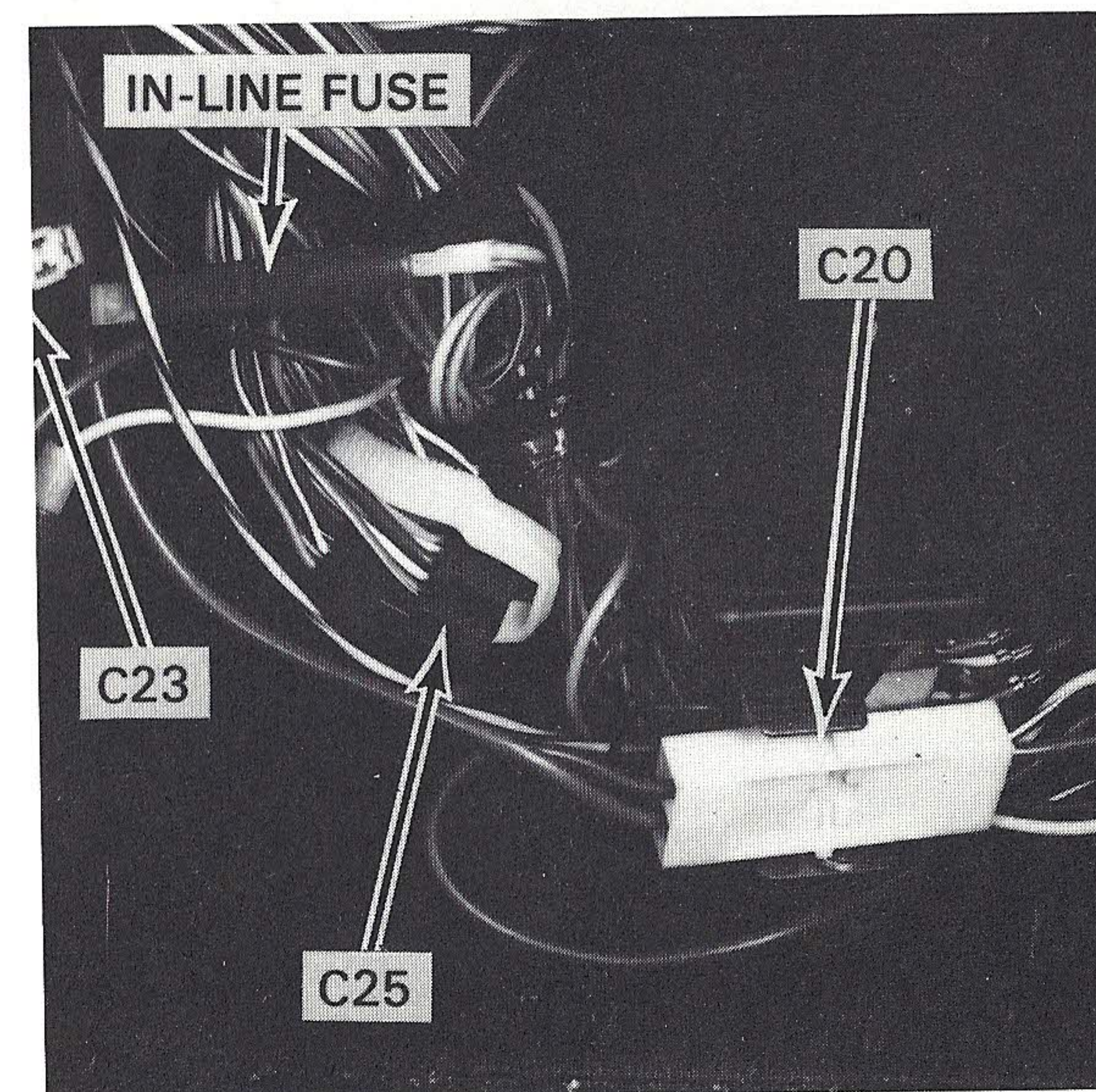
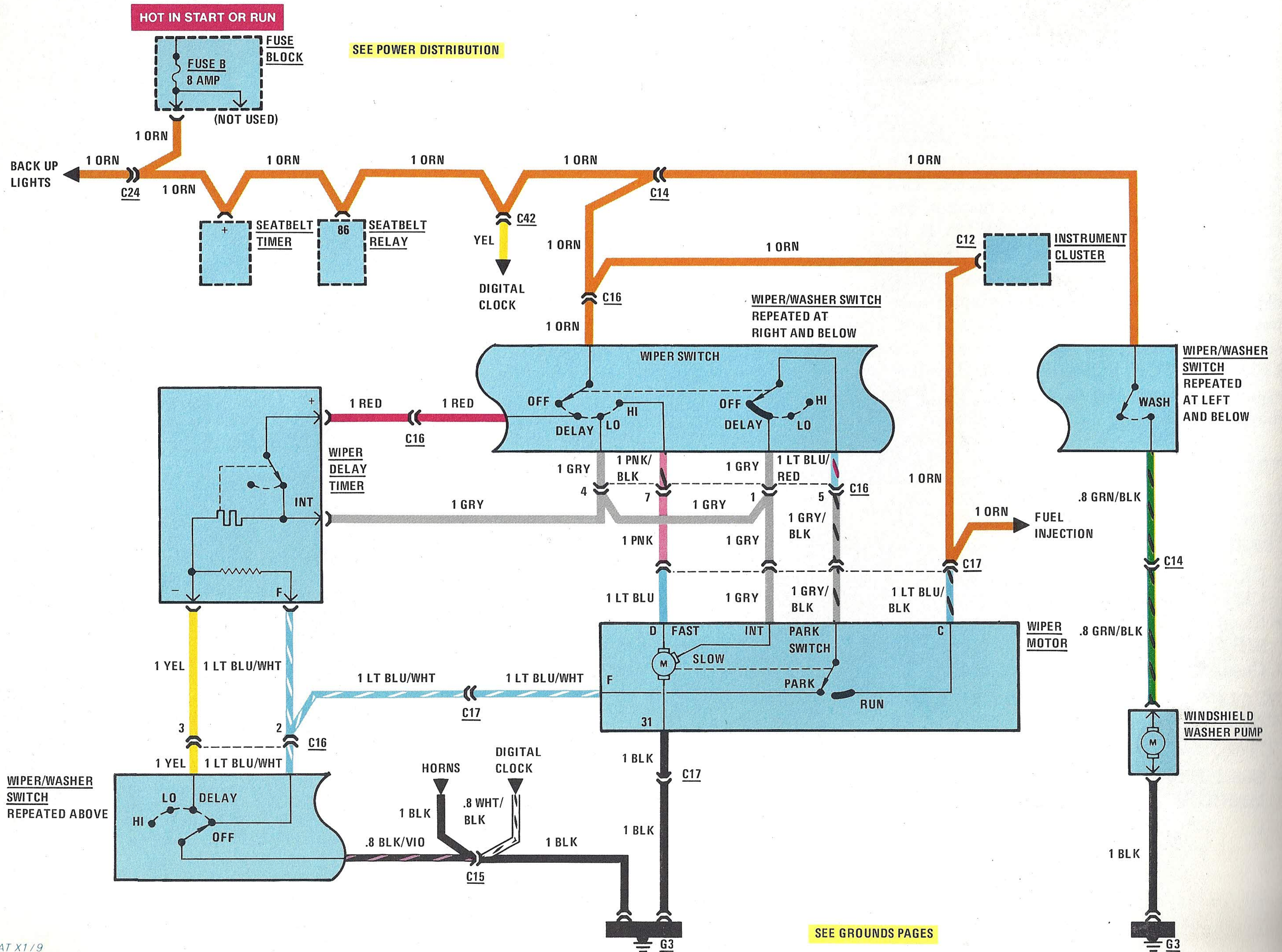

Figure 2 - LH Side of Relay Panel

WINDSHIELD WIPER/WASHER



CIRCUIT OPERATION

Wiper Operation

With the IGNITION SWITCH in "Start" or "Run," voltage is applied through FUSE B to the wiper switch and to the "Run" contact of the park switch in the WIPER MOTOR.

Continuous Operation

With the WIPER/WASHER SWITCH in "Lo," current flows through terminal 4 of C16, the GRY wires, and the WIPER MOTOR to ground. With the WIPER/WASHER SWITCH in "Hi," current is directed through the PNK/BLK, PNK, and LT BLU wires, and the motor to ground.

Park Cycle

When the wipers are running, the park switch is in "Run". The park switch is mechanically linked to the motor and moves to "Park" only when the wipers are in park position on the windshield. When the switch assembly is placed in "Off," current to bring the wipers to the park position flows through FUSE B, the ORN wire, the "Run" contact of the park switch, the GRY/BLK wire, terminal 5 of C16, the WIPER/WASHER SWITCH, terminal 1 of C16, and the motor to ground. The motor continues to run until the run contact opens, and the wipers are parked.

Delay Operation

When the WIPER/WASHER SWITCH is placed in "Delay," current flows through the RED wire and terminal (+) of the WIPER DELAY TIMER. This current powers the timer. It flows through terminal (-) of the timer then through terminal 3 of C16 and the WIPER/WASHER SWITCH to G3. A pulse

COMPONENT LOCATION

| | | Page-Figure |
|------------------------------|--|-------------|
| Fuse Block | Attached to top rear of relay panel | 64-1, 6-1 |
| Seatbelt Relay | Attached to relay panel | 64-1 |
| Seatbelt Timer | Attached to relay panel | 64-1 |
| Windshield Washer Pump | Inside windshield washer reservoir | 50-1 |
| Wiper Delay Timer | Attached to relay panel | 64-1 |
| C12 (6 cavities) | Connected to LH rear of instrument cluster . | 57-1 |
| C14 (6 cavities) | Behind instrument cluster | 59-3 |
| C15 (5 cavities) | Behind instrument cluster | 47-1 |
| C16 (8 cavities) | Behind instrument cluster | 47-1 |
| C17 (6 cavities) | To left of windshield washer reservoir | 25-1 |
| C24 (12 cavities) | Above relay panel | 35-1 |
| C42 (4 cavities) | Behind digital clock | 59-2 |
| G3 | Under dash panel, to left of steering column | |

of current also flows through terminal INT of the WIPER DELAY TIMER, the GRY wires and the motor to ground. This starts the wiper sweep and puts the park switch in "Run." The wipers complete the sweep as a park cycle, and wait for another pulse of current.

Washer Operation

With the IGNITION SWITCH in "Run," voltage is applied through FUSE B, the ORN wire and the GRY/BLK wire to the wash switch. When the switch is closed, current flows through the WINDSHIELD WASHER PUMP to G3. The pump squirts fluid onto the windshield as long as the switch is closed.

TROUBLESHOOTING

IF WIPERS DO NOT OPERATE IN "DELAY":

- Check for voltage at LT BLU wire of C12.
- Check for voltage at RED wire of C12, male pin.

- Check for continuity to ground from YEL wire of C12 to G3.

IF WIPERS ONLY MAKE ONE SWEEP AND STOP:

- Check for continuity from C13, through the park switch to LT BLU/WHT wire of C12.

IF WIPER AND WASHER DO NOT WORK:

- Check FUSE B.

IF WINDSHIELD WIPER WORKS IN "SLOW" BUT NOT "FAST":

- Check voltage at GRY wire. If there is no voltage present, check switch. If there is voltage, check G2 and check motor.

IF WINDSHIELD WASHER PUMP DOES NOT WORK:

- Check continuity between terminals m and t of WINDSHIELD WIPER/WASHER SWITCH ASSEMBLY, and between switch assembly and G1.

WINDSHIELD WIPER/WASHER

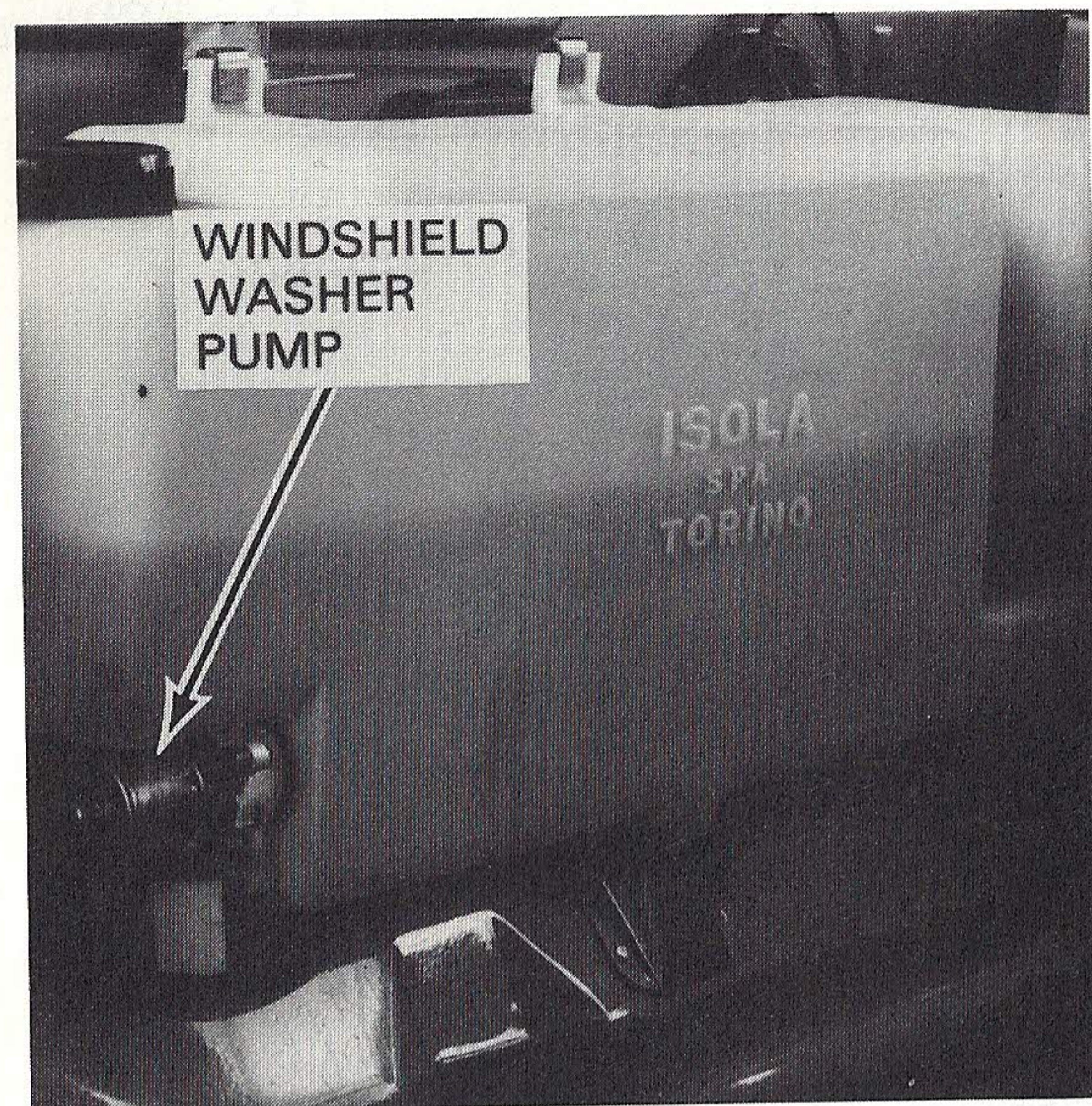

Figure 1 — Rear of Front Compartment

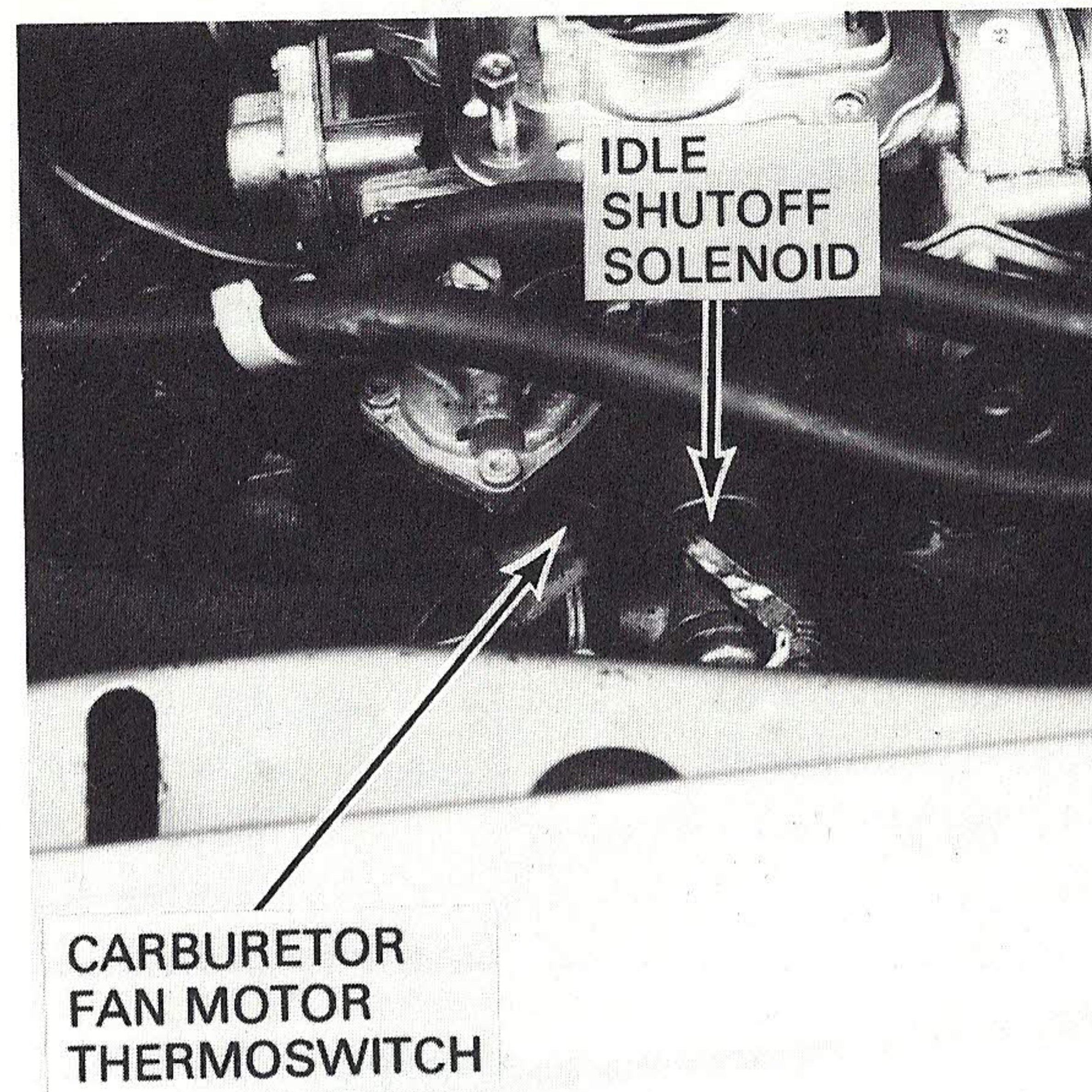

Figure 3 — Behind Carburetor

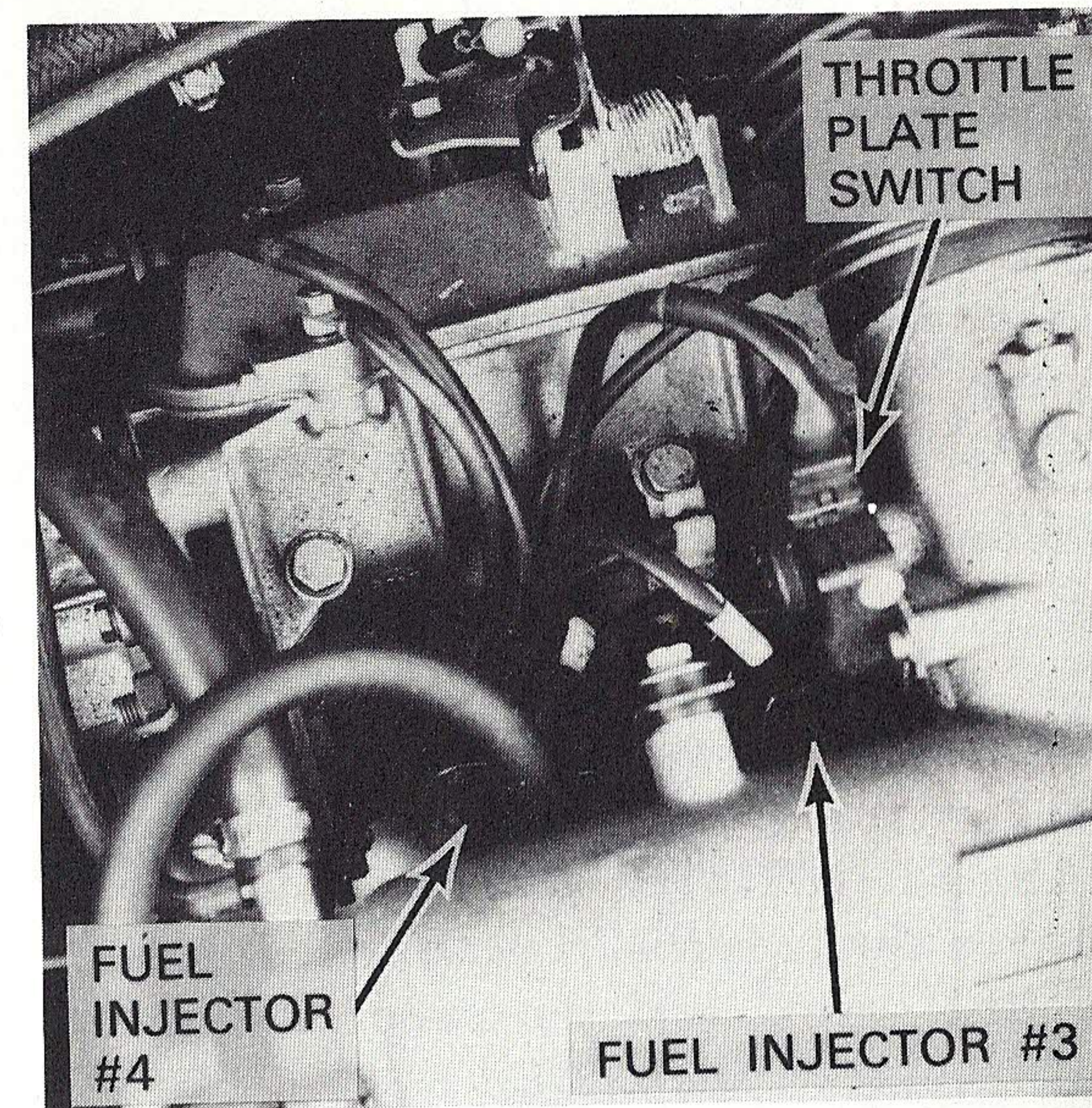

Figure 5 — To LH Side of Engine

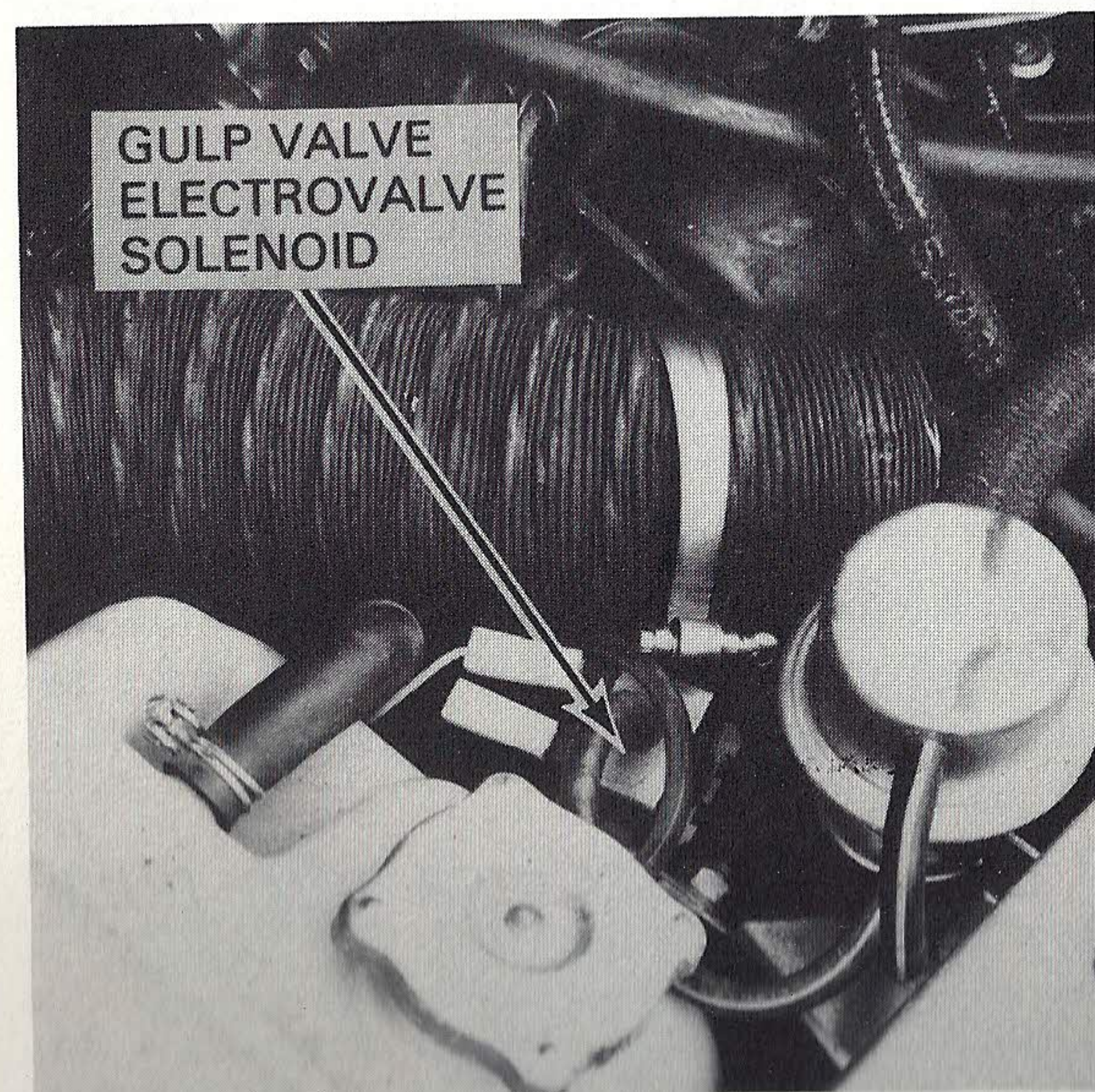

Figure 2 — To Left of Coolant Reservoir

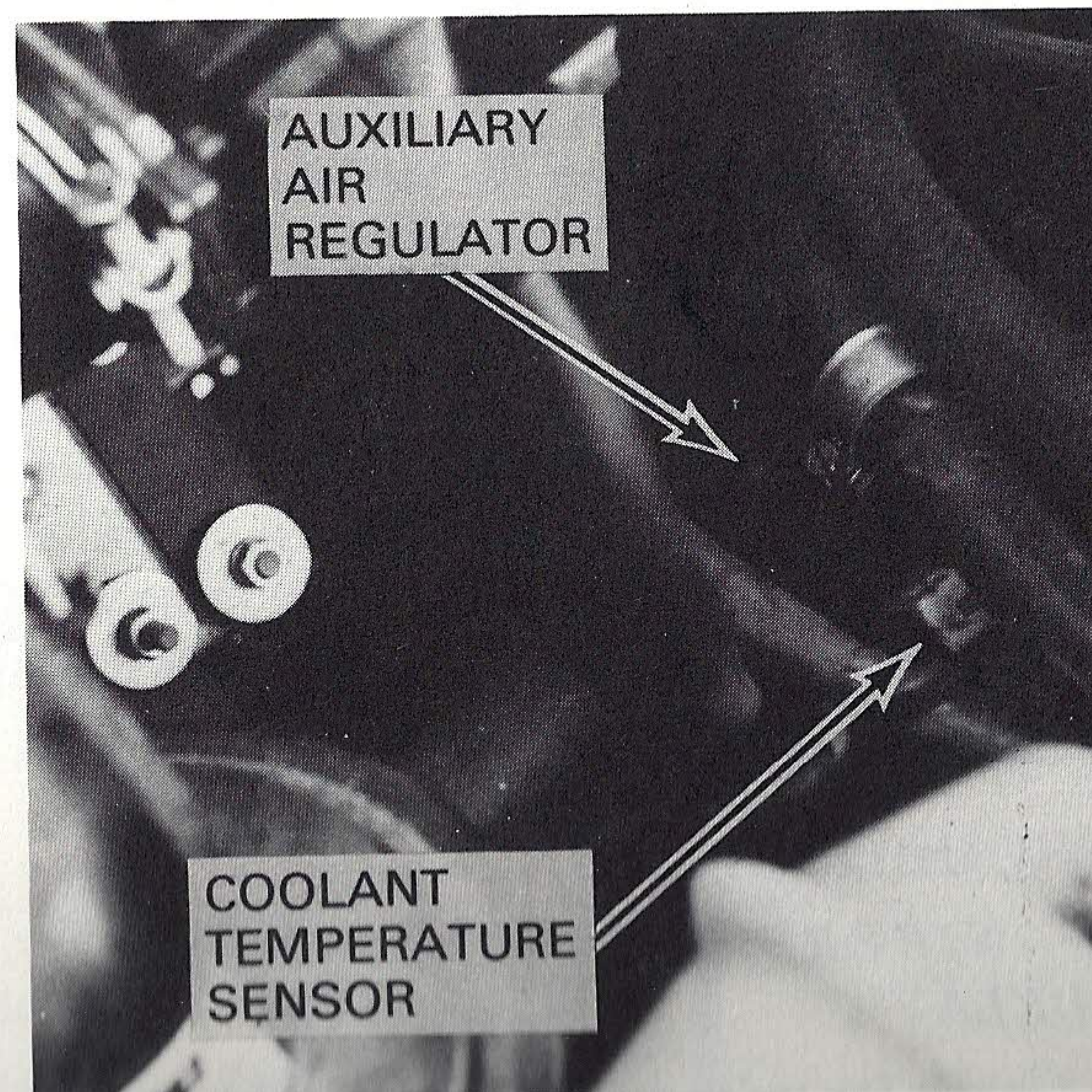

Figure 4 — LH Side of Carburetor

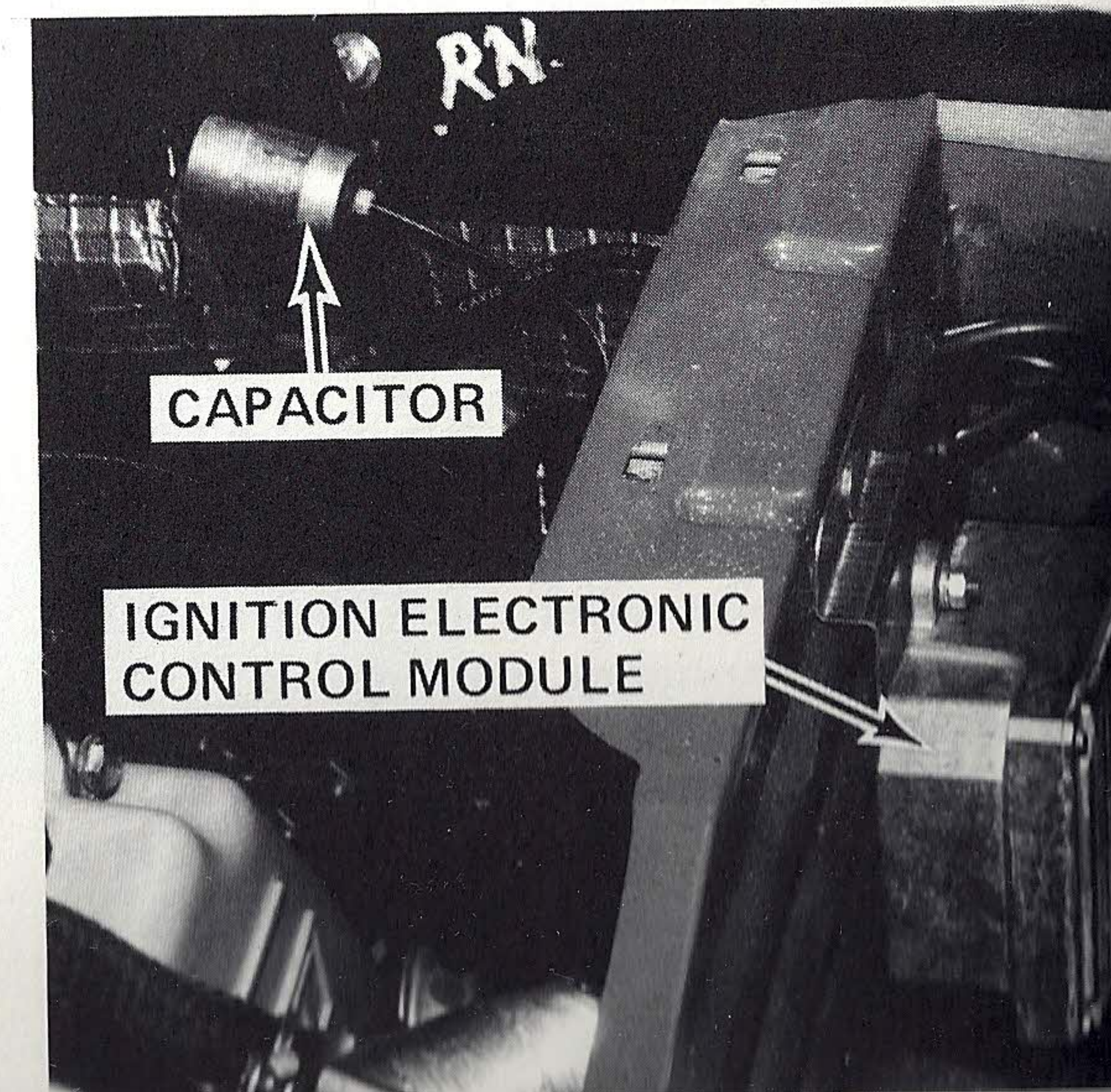

Figure 6 — RH Side of Engine Compartment

COMPONENT LOCATION

| | | |
|------------------------|--|----------|
| Fuse Block | Attached to top rear of relay panel..... | 64-1,6-1 |
| Horn Relay..... | Attached to relay panel..... | 64-1 |
| Horn Slip Ring | Upper part of steering column | 51-1 |
| C14 (6 cavities) | Behind instrument cluster | 59-3 |
| C15 (5 cavities) | Behind instrument cluster | 47-1 |
| G3..... | Under dash panel, to left of steering column | |

CIRCUIT OPERATION

Voltage is applied through FUSE N and the HORN RELAY coil to the HORN SWITCH at all times. When the HORN SWITCH is closed, current flows through the relay coil, HORN SLIP RING and HORN SWITCH to G3. The coil then closes the relay contacts, and current flows through the LT/BLU wires and the HORNS to ground.

TROUBLESHOOTING

IF THE HORNS DON'T SOUND:

- Check that G3 is clean and tight.
- Check FUSE N.

IF HORNS SOUND AT ALL TIMES:

- Check for stuck or shorted HORN SWITCH.
- Check for "short" to ground in BLK/VIO wires.
- Check for "short" between HORN RELAY terminals 30 and 87.

SEE POWER DISTRIBUTION

HOT AT ALL TIMES

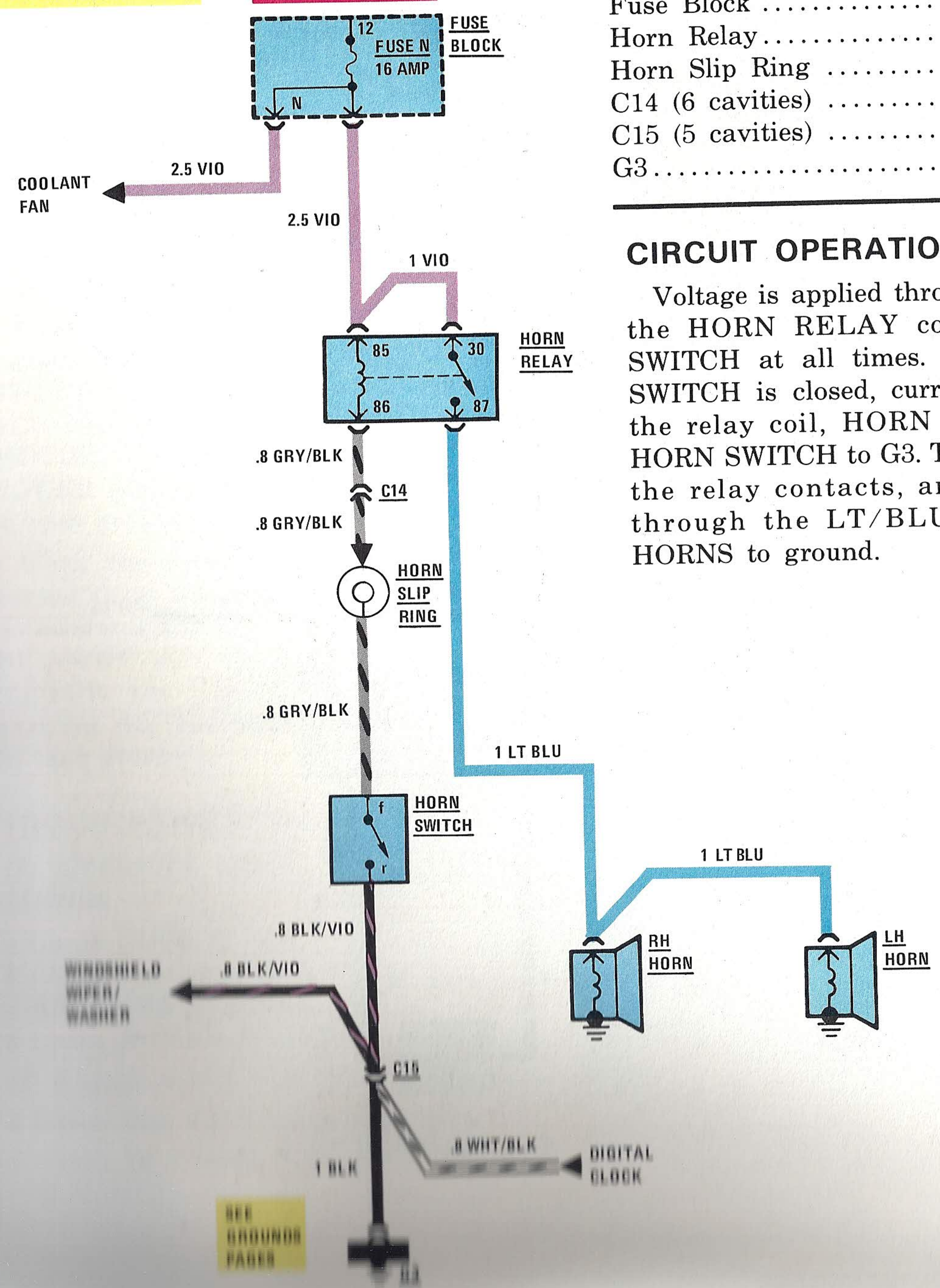

SEE GROUNDING PAGES

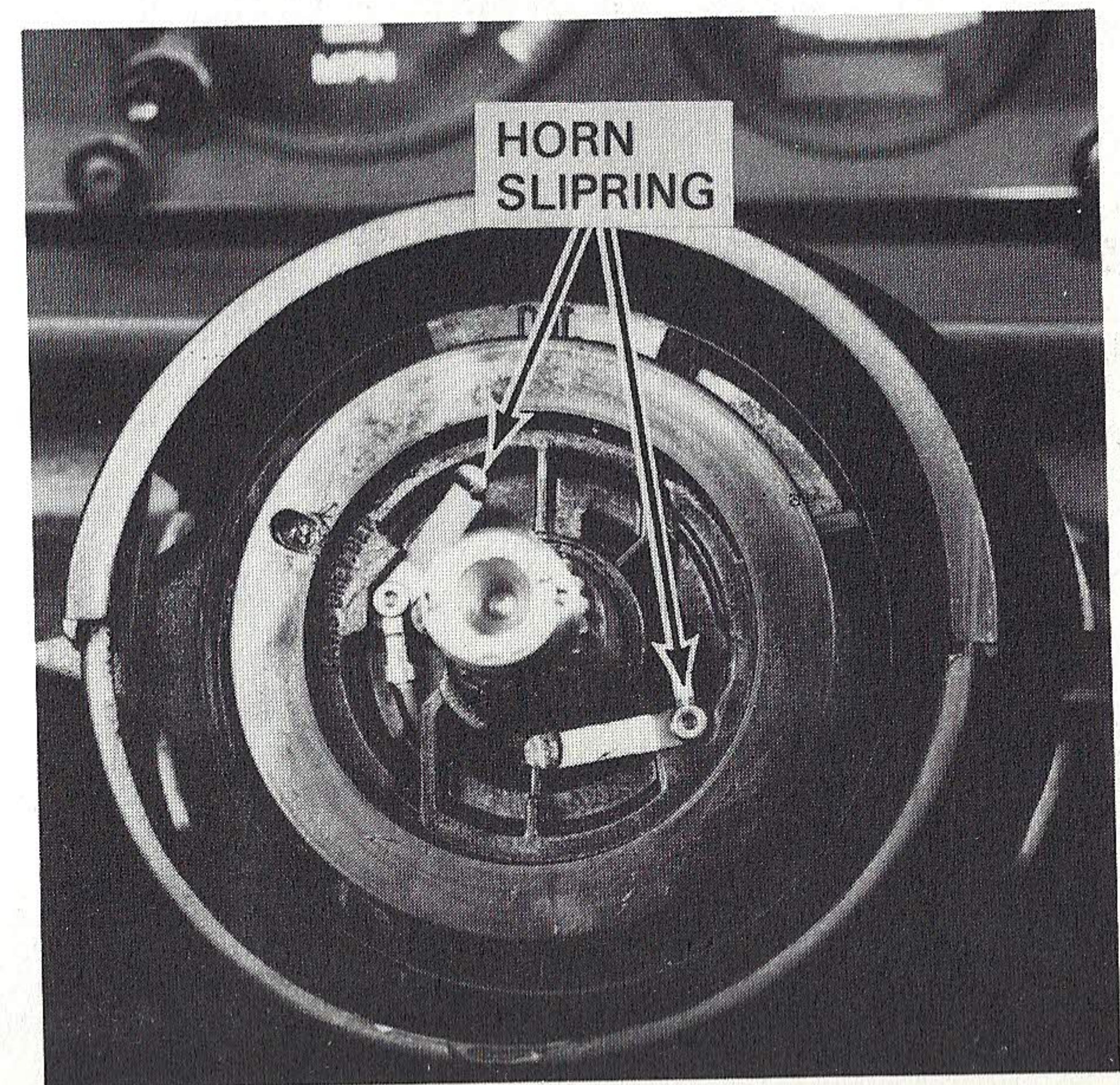
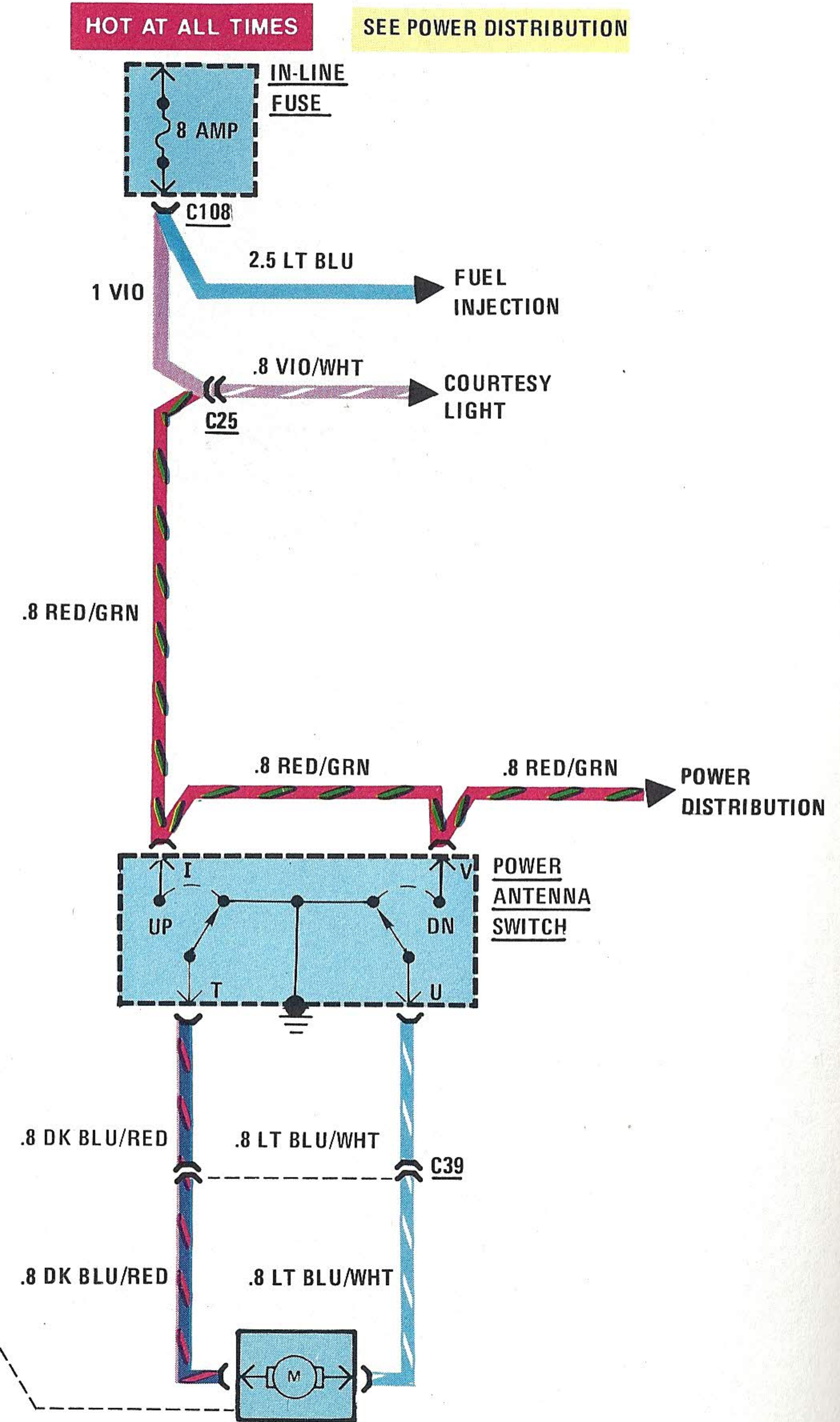
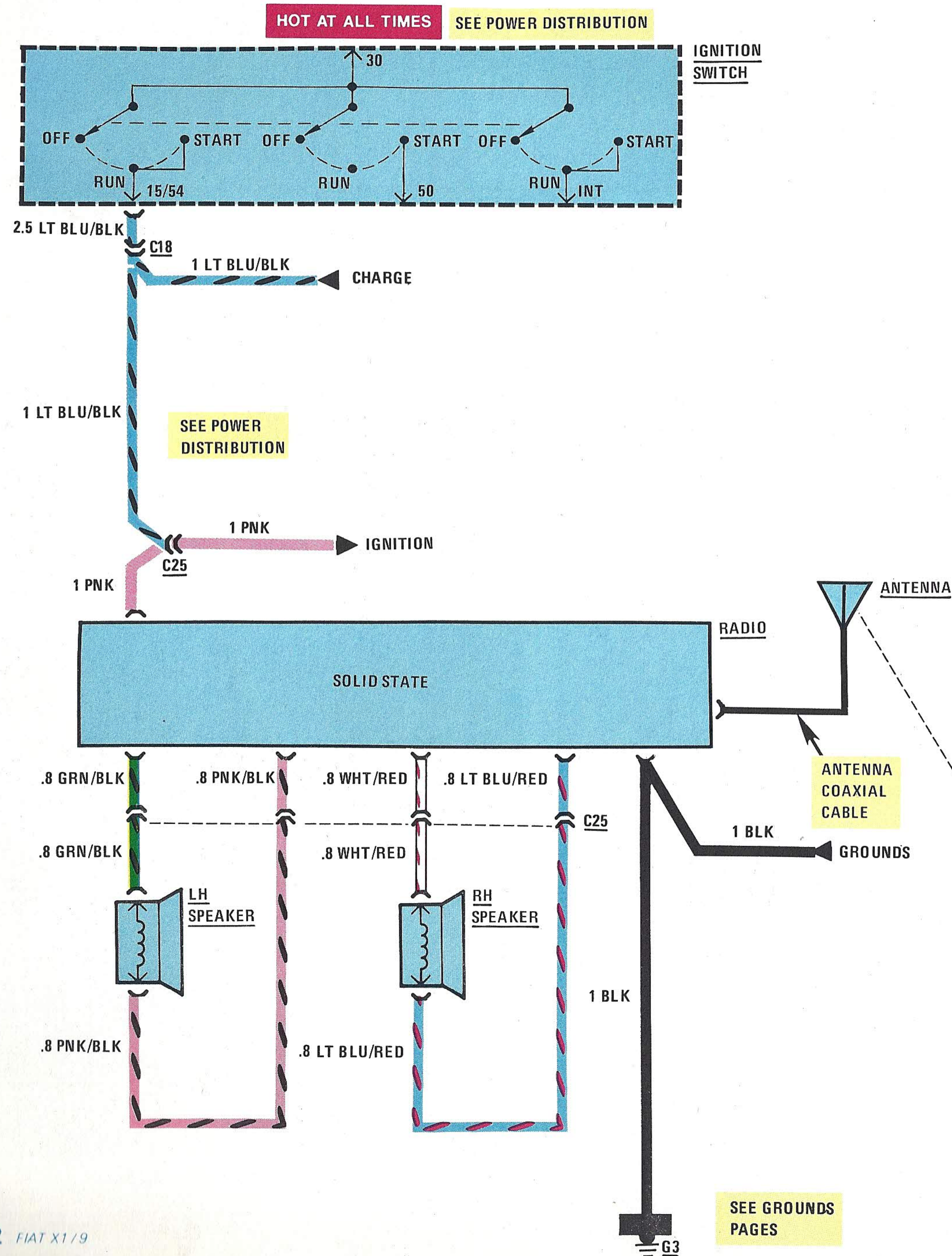

Figure 1 - Steering Column

RADIO/POWER ANTENNA



CIRCUIT OPERATION

Radio

With the IGNITION SWITCH in "Run" or "Start," voltage is available to power the RADIO.

Power Antenna

Voltage is applied at all times through the IN-LINE FUSE to the POWER ANTENNA SWITCH.

When the switch is pressed to "Up," current flows through POWER ANTENNA SWITCH terminals I and T, the DK BLU/RED wire, the POWER ANTENNA MOTOR, the LT BLU/WHT wire, and POWER ANTENNA SWITCH terminal U to case ground.

When the switch is pressed to "Dn," current flows through POWER ANTENNA SWITCH terminals V and U, the LT BLU/WHT wire, the POWER ANTENNA MOTOR, the DK BLU/RED wire, and POWER ANTENNA SWITCH terminal T to case ground.

TROUBLESHOOTING

IF ANTENNA DOES NOT RAISE OR LOWER:

- Check FUSE I.
- Check case ground on POWER ANTENNA SWITCH.
- Check POWER ANTENNA MOTOR.

IF RADIO DOES NOT WORK:

- Check that G3 is clean and tight.
- Check for voltage at LT BLU/BLK wire in RADIO.

COMPONENT LOCATION

| | | Page-Figure |
|-----------------------------|--|-------------|
| Fuse Block | Attached to top rear relay panel | 64-1 |
| Ignition Switch..... | Attached to RH side of steering column | 41-1 |
| Power Antenna Motor..... | | |
| (with carburetor) | In LH rear fender | 53-1 |
| (with fuel injection) | In RH rear fender | |
| Power Antenna Switch..... | Part of center console | 55-2 |
| C18 (4 cavities) | Behind instrument cluster | 47-1 |
| C25 (12 cavities) | Above relay panel | 57-2 |
| C39 (2 cavities) | Above relay panel | 35-1 |
| G3..... | Under dash panel, to left of steering column | |

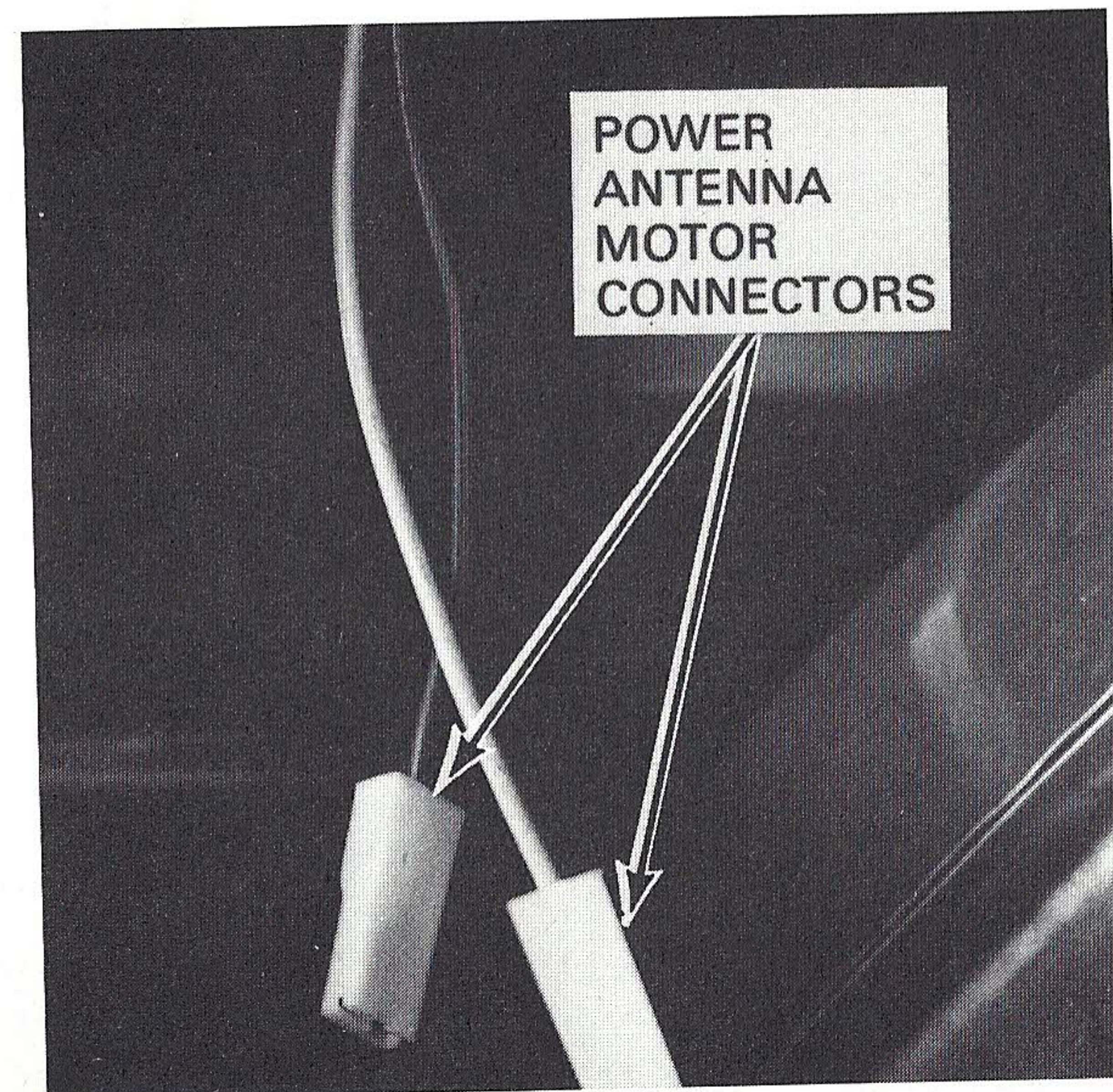

Figure 1 - Behind LH Rear Wheel Well

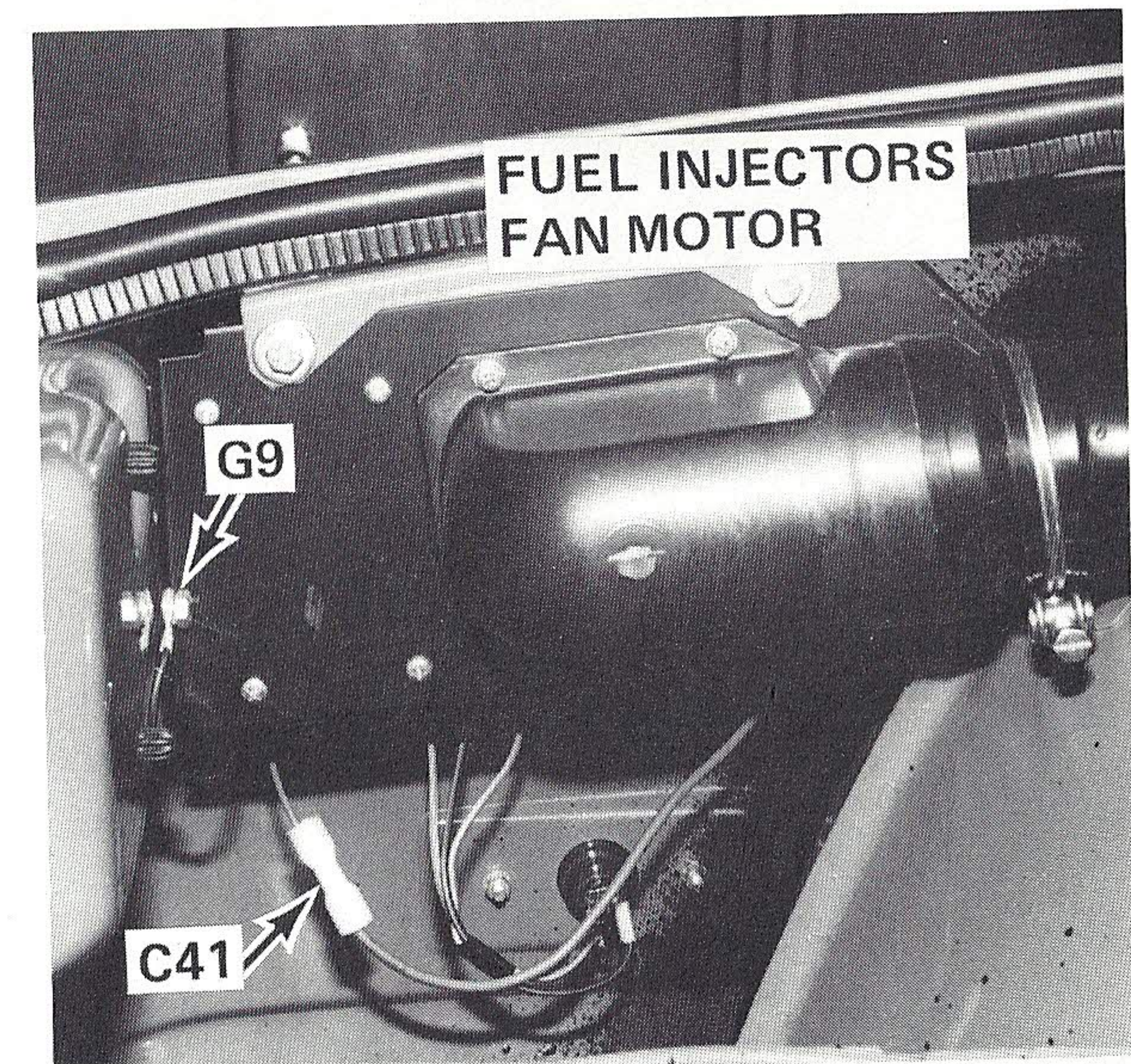
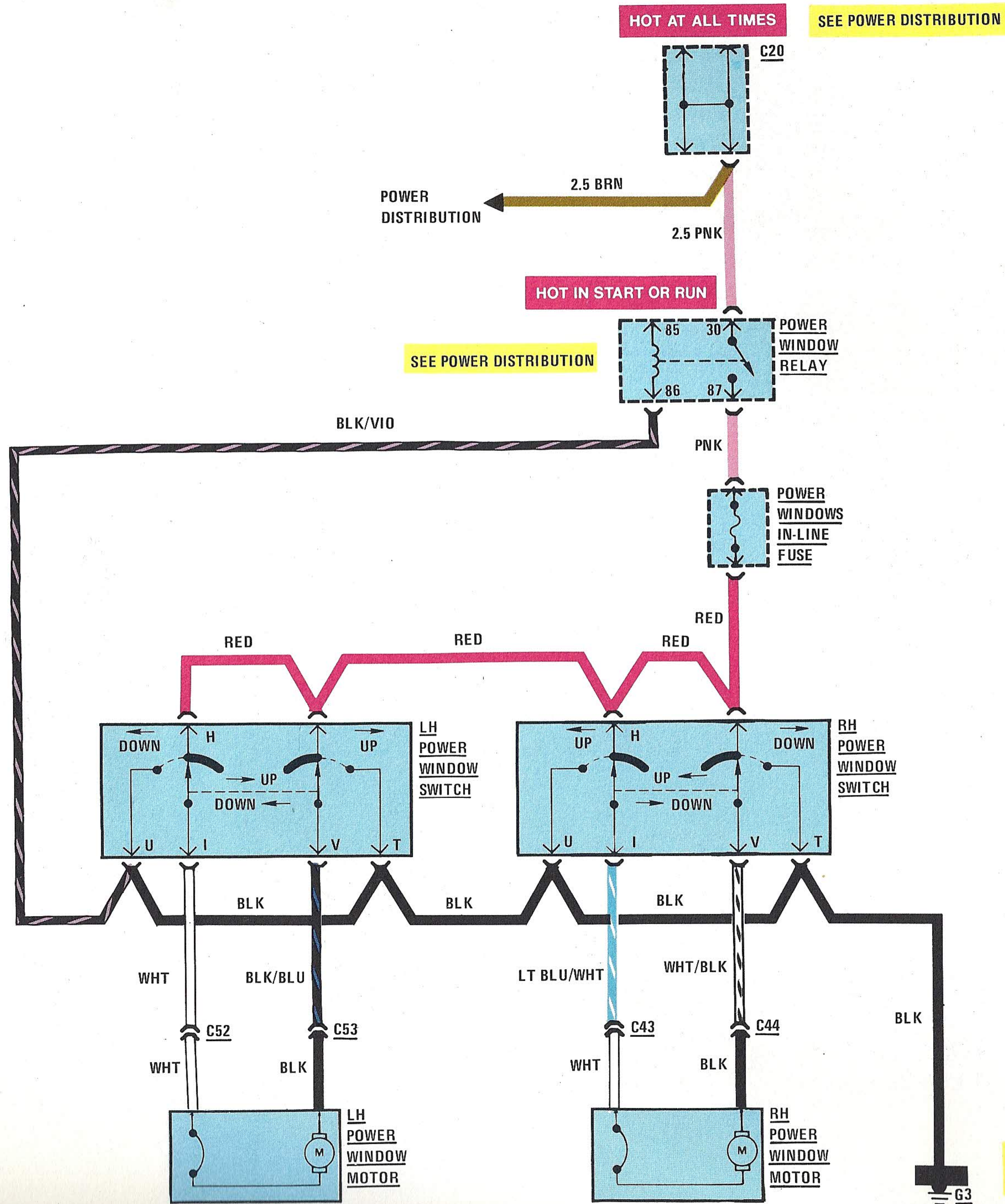

Figure 2 - LH Rear Luggage Compartment

POWER WINDOWS



SEE POWER DISTRIBUTION

SEE POWER DISTRIBUTION

SEE GROUNDS PAGES

CIRCUIT OPERATION

Voltage is applied at all times to POWER WINDOW RELAY terminal 30. With the IGNITION SWITCH in "Start" or "Run," current flows through the POWER WINDOW RELAY coil to G3. The relay contacts close and power is available to operate the POWER WINDOW MOTORS through terminal 87.

When the RH POWER WINDOW SWITCH is placed in "Down," current flows through the POWER WINDOWS IN-LINE FUSE, terminals H and I of the switch, the motor, and terminals V and T of the power window switch to G3. When the window switch is placed in "Up," current flows through the POWER WINDOWS IN-LINE FUSE, the unmarked terminal and terminal V of the switch, the motor, and terminals I and U to ground. Current flow is similar for the LH POWER WINDOW SWITCH.

TROUBLESHOOTING

IF NEITHER POWER WINDOW WORKS:

- With IGNITION SWITCH in "Start" or "Run," check for 12 volts at POWER WINDOWS IN-LINE FUSE.
- Check that G3 is clean and tight.
- Check that C20 is tight.

IF ONE POWER WINDOW DOES NOT WORK:

- Check the POWER WINDOW MOTOR connector.
- Check the POWER WINDOW MOTOR circuit breakers.

COMPONENT LOCATION

| | | Page-Figure |
|----------------------------|--|-------------|
| LH Power Window Motor | Inside front of LH door | |
| LH Power Window Switch ... | LH side of console | 55-1 |
| Power Window Relay | Attached to relay panel..... | 64-1 |
| Power Windows In- | | |
| Line Fuse | Above relay panel | 67-4 |
| RH Power Window Motor | Inside front of RH door | |
| RH Power Window Switch ... | RH side of console | 55-1 |
| C20 (4 cavities) | Top LH side of relay panel | 57-2 |
| C43 (1 cavity) | Inside RH door | |
| C44 (1 cavity) | Inside RH door | |
| C52 (1 cavity) | Inside LH door | |
| C53 (1 cavity) | Inside LH door | |
| G3 | Under dash panel, to left of steering column | |

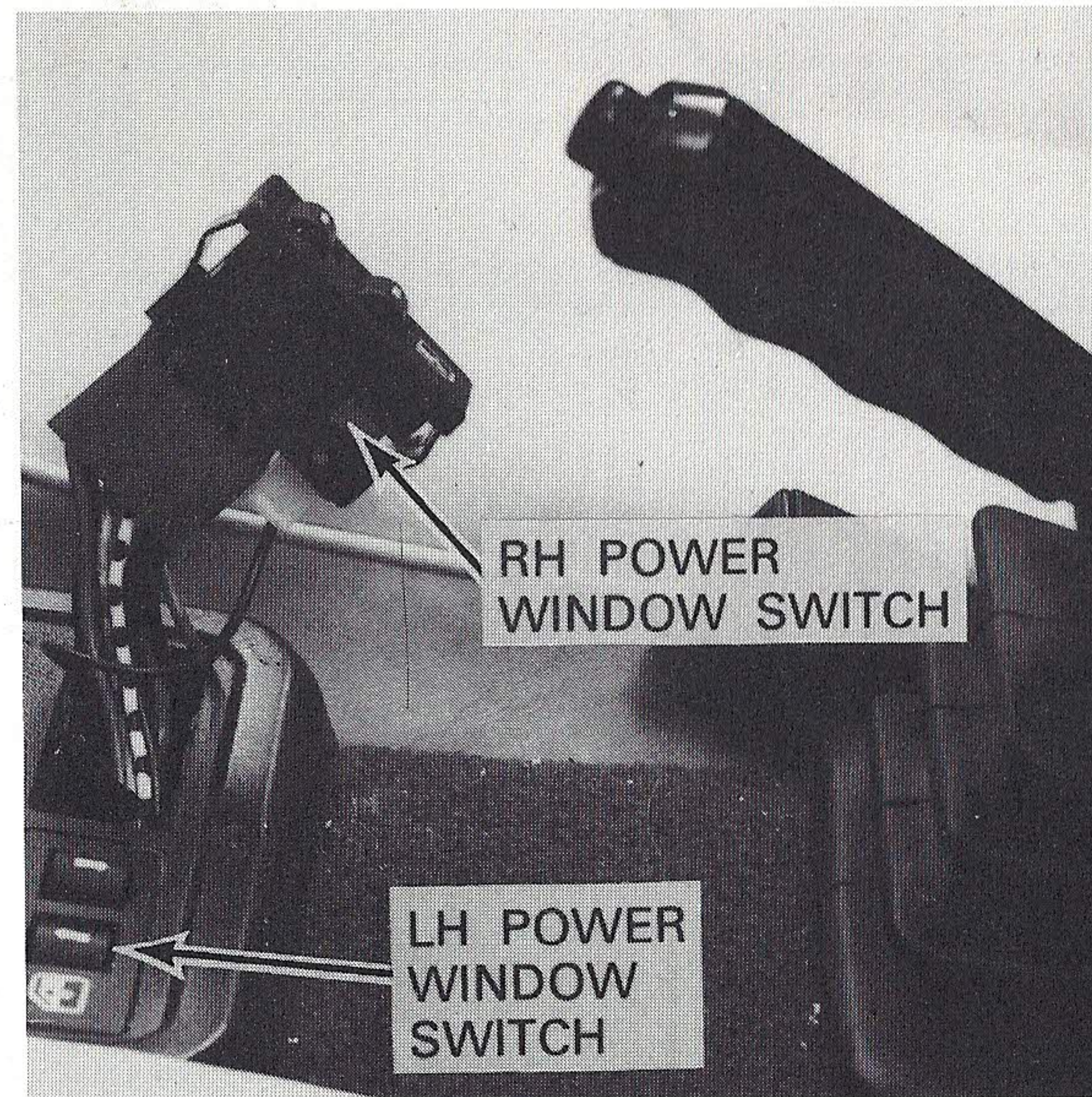

Figure 2 - Behind Center Console

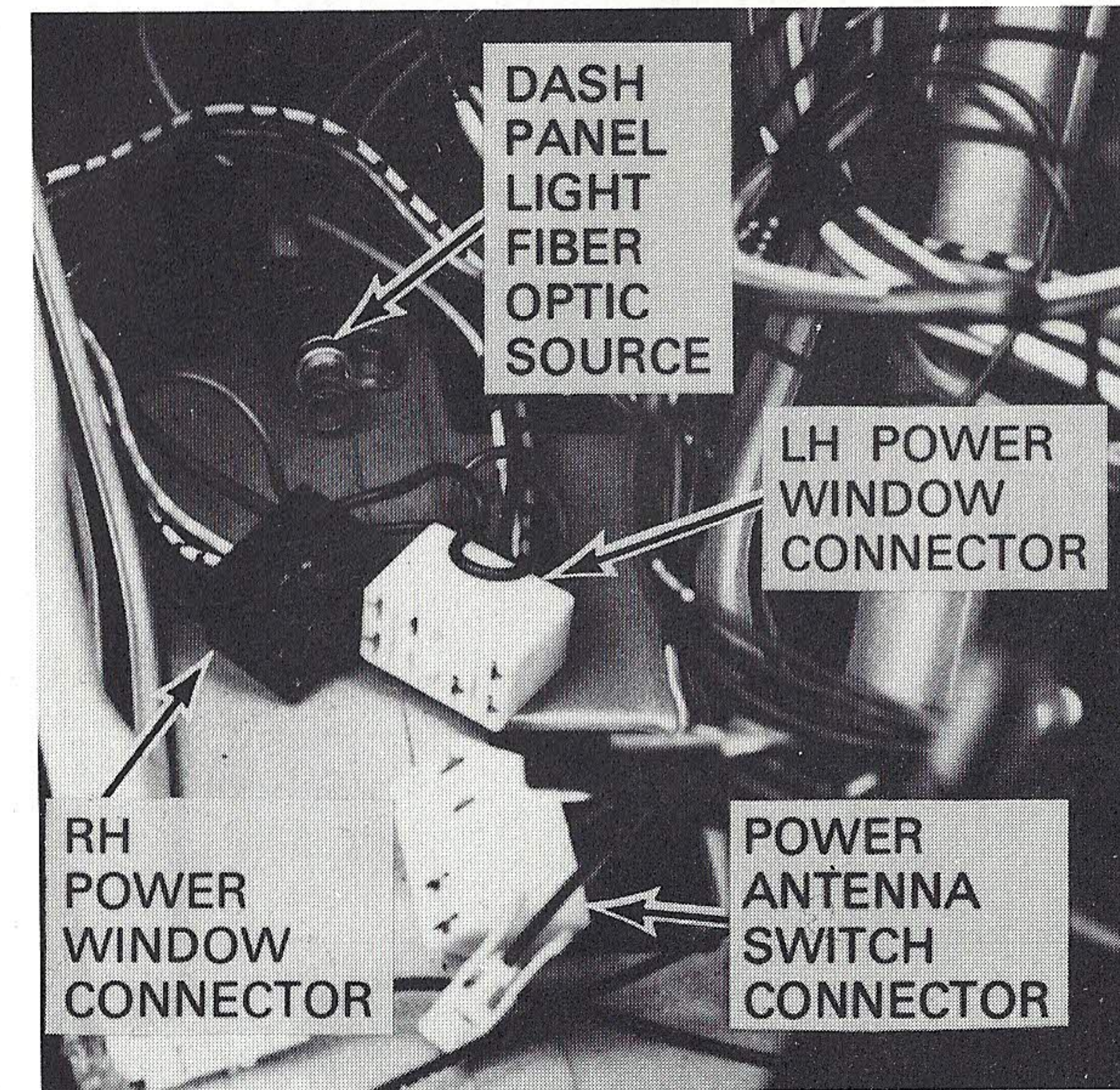
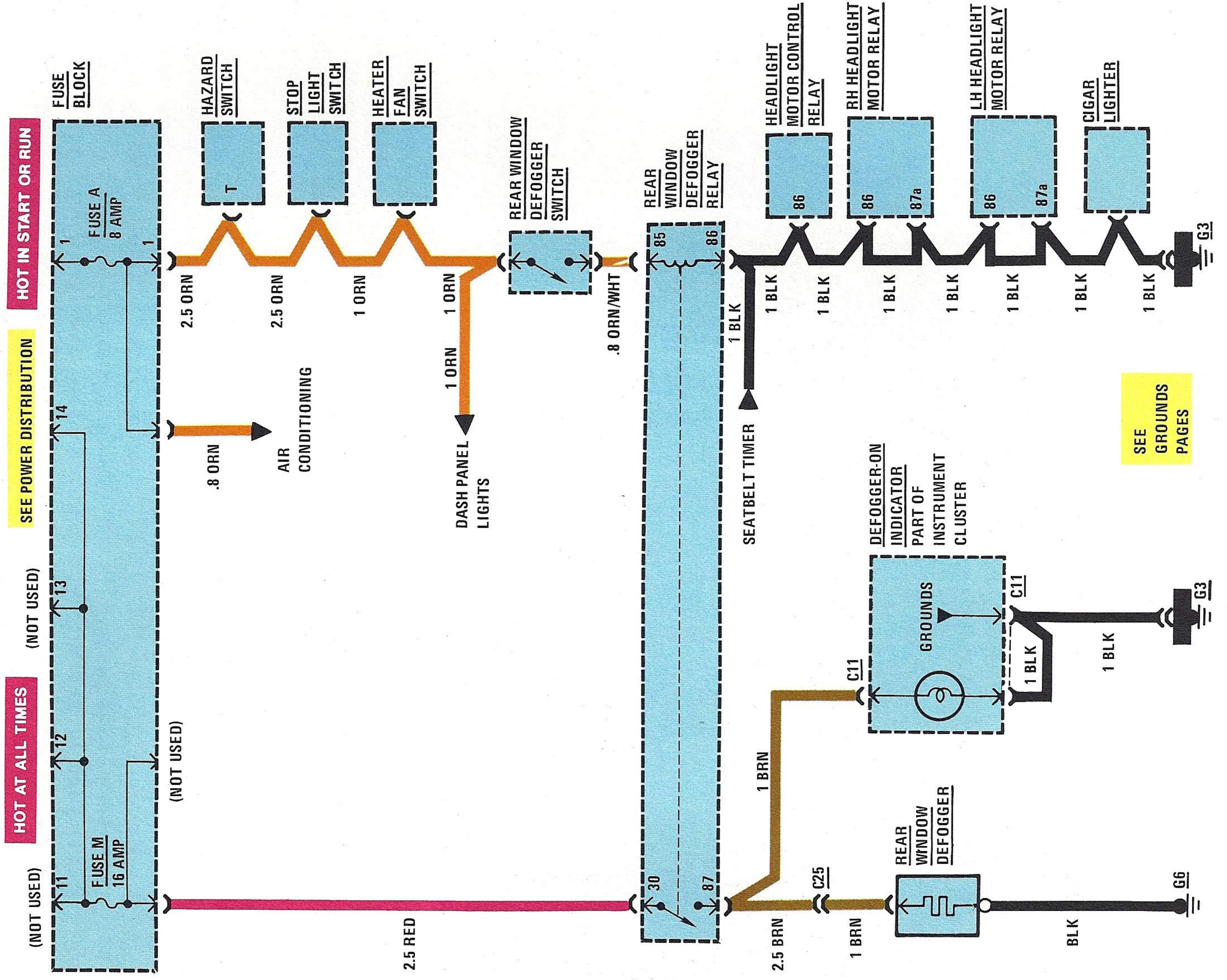

Figure 1 - Base of Gear Shift Selector

REAR WINDOW DEFOGGER



CIRCUIT OPERATION

With the IGNITION SWITCH in "Start" or "Run," voltage is applied through FUSE A to the REAR WINDOW DEFOGGER SWITCH. Voltage is always applied through FUSE M to terminal 30 of the REAR WINDOW DEFOGGER RELAY SWITCH is closed, current flows through the REAR WINDOW DEFOGGER RELAY coil to G3. The relay contacts close and current flows through FUSE M, the relay contacts, the REAR WINDOW DEFOGGER and to G6. Current also flows through the DEFOGGER-ON INDICATOR and to G3.

TROUBLESHOOTING

IF BOTH DEFOGGER AND INDICATOR DON'T WORK:

- Check G3 by operating CIGAR-LIGHTER
- Check FUSE A by operating HEATER FAN.
- Check FUSE M by operating HAZARD LIGHTS.
- Check relay by unplugging it and inserting a shorting wire between cavities 30 and 87.

IF INDICATOR WORKS BUT DEFOGGER DOESN'T:

- Check that G6 is clean and tight.

COMPONENT LOCATION

| | | Page-Figure |
|-------------------------------------|--|-------------|
| Fuse Block | Rear of relay panel..... | 64-1, 6-1 |
| Hazard Switch | Upper portion of center console | 41-1 |
| Heater Fan Switch | Upper LH corner of center of dash panel.... | 41-1 |
| LH Headlight Motor Relay .. | Attached to relay panel..... | 64-1 |
| Headlight Motor Control Relay | Attached to relay panel..... | 64-1 |
| Rear Window Defogger Relay | Attached to relay panel..... | 64-1 |
| Rear Window Defogger Switch | Upper portion of center console | 41-1 |
| RH Headlight Motor Relay .. | Attached to relay panel..... | 64-1 |
| Stop Light Switch..... | Attached to brake pedal support | 58-2 |
| C11 (5 cavities) | Connected to LH rear of instrument cluster . | 57-1 |
| C25 (12 cavities) | Above relay panel | 57-2 |
| G3..... | Under dash panel to left of steering column | |
| G6..... | Attached to left of rear window | |

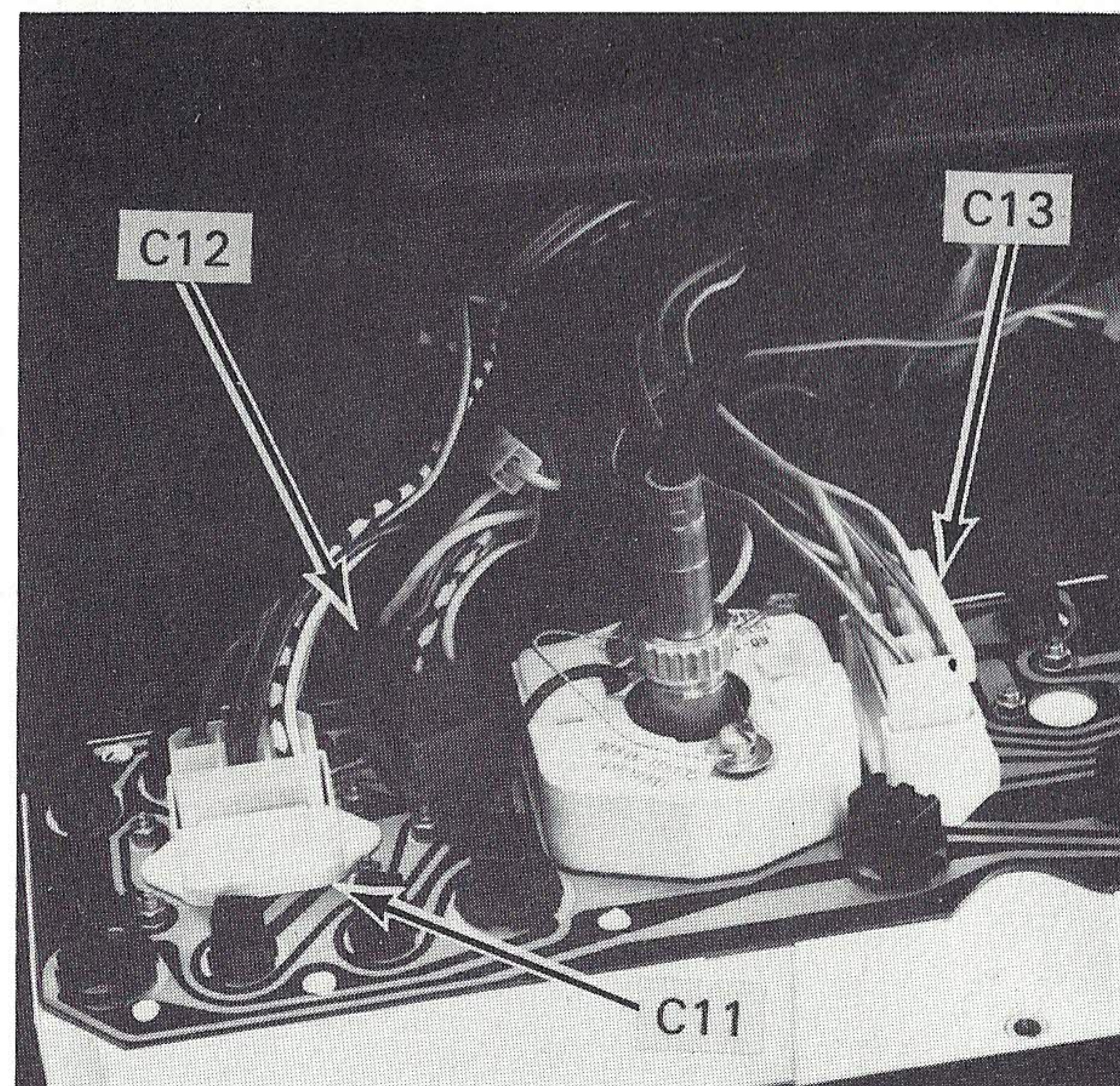

Figure 1 - Back of Instrument Cluster

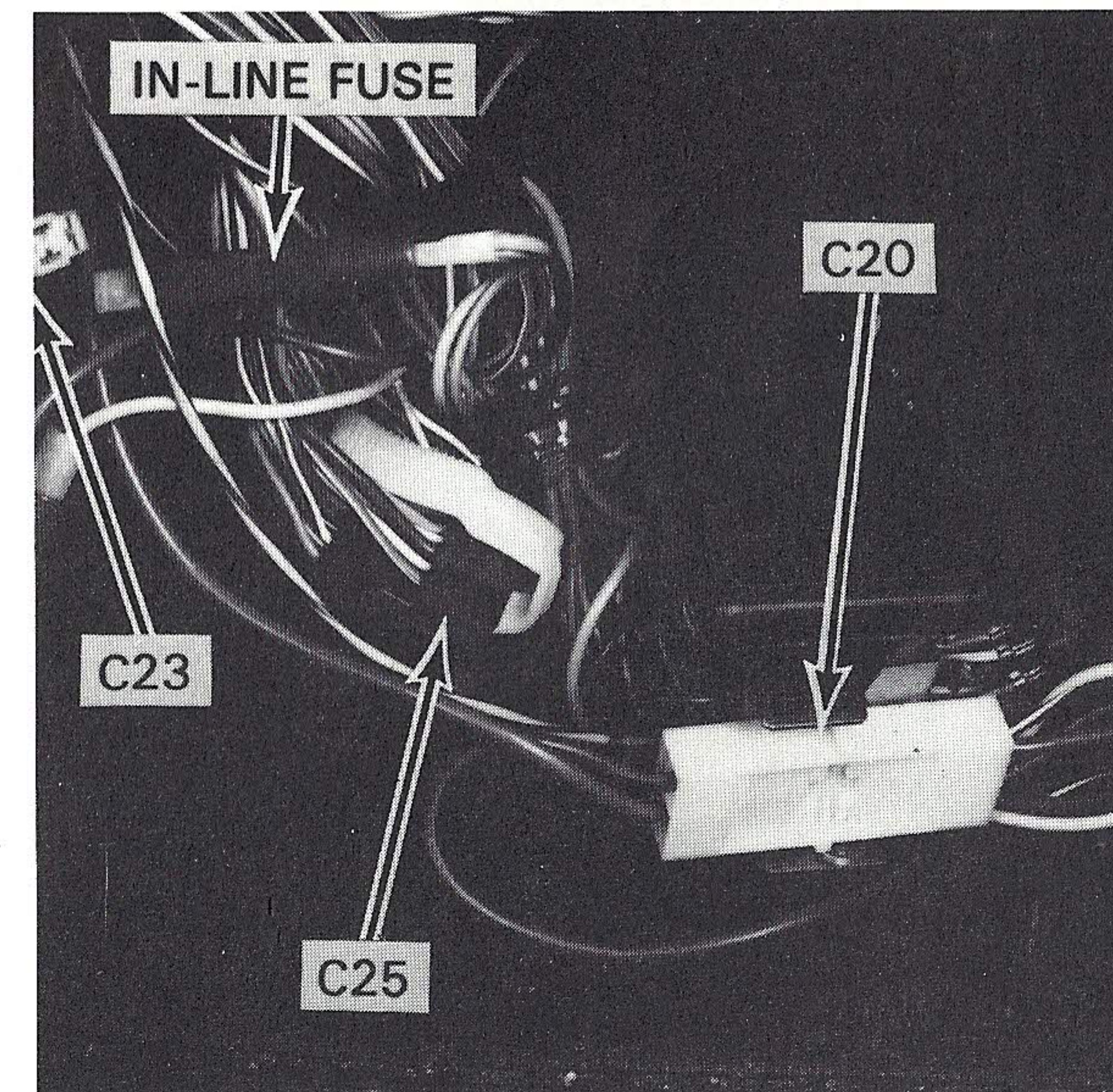
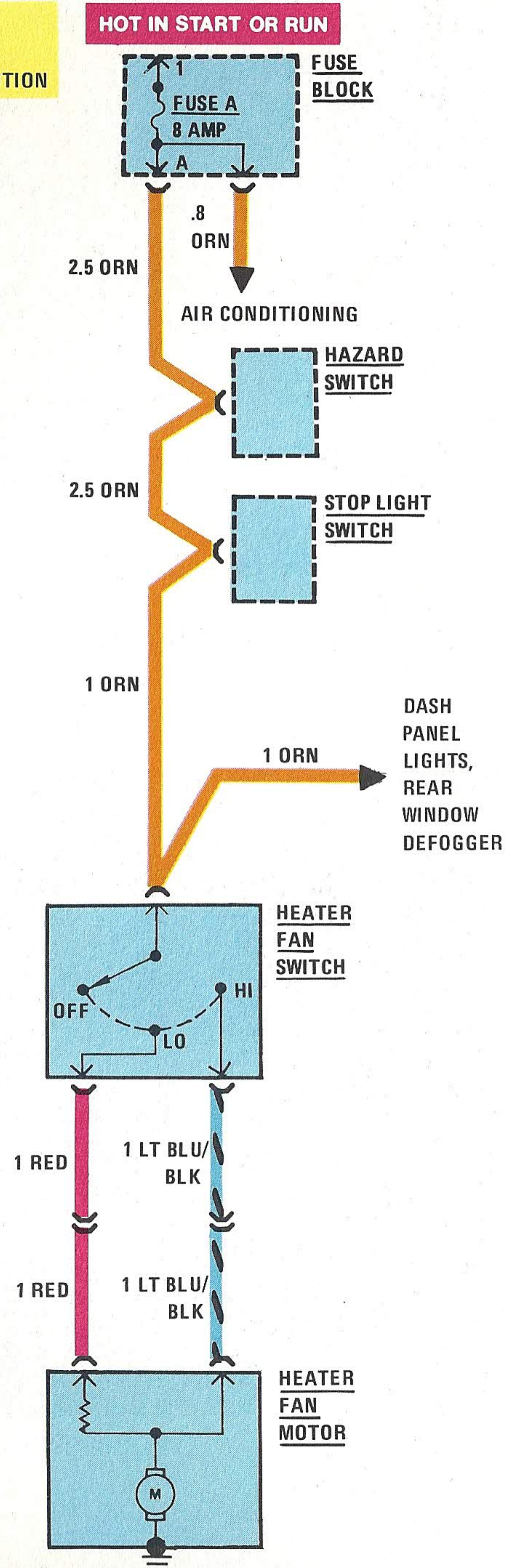

Figure 2 - LH Side of Relay Panel

SEE
POWER
DISTRIBUTION



COMPONENT LOCATION

| Component | Location | Page-Figure |
|-------------------|--|-------------|
| Fuse Block | Attached to top rear of relay panel | 64-1 |
| Hazard Switch | Attached to top RH side of relay panel | 41-1 |
| Heater Fan Motor | Behind center console | |
| Heater Fan Switch | LH center of dash panel | 41-1 |
| Stop Light Switch | Attached to brake pedal support | 58-2 |

CIRCUIT OPERATION

With the IGNITION SWITCH in "Run" or "Start," voltage is applied through FUSE A to the HEATER FAN SWITCH. When the HEATER FAN SWITCH is placed in "Lo," current flows through the switch, resistor, and HEATER FAN MOTOR to ground. In "Hi," current flows through the switch and the motor to ground.

TROUBLESHOOTING

IF HEATER FAN MOTOR DOES NOT WORK:

- Check FUSE A by operating Hazard Lights.
- Test operation of STOP LIGHT SWITCH. If switch operates, check HEATER FAN SWITCH connector or check for short in 1 ORN wire.

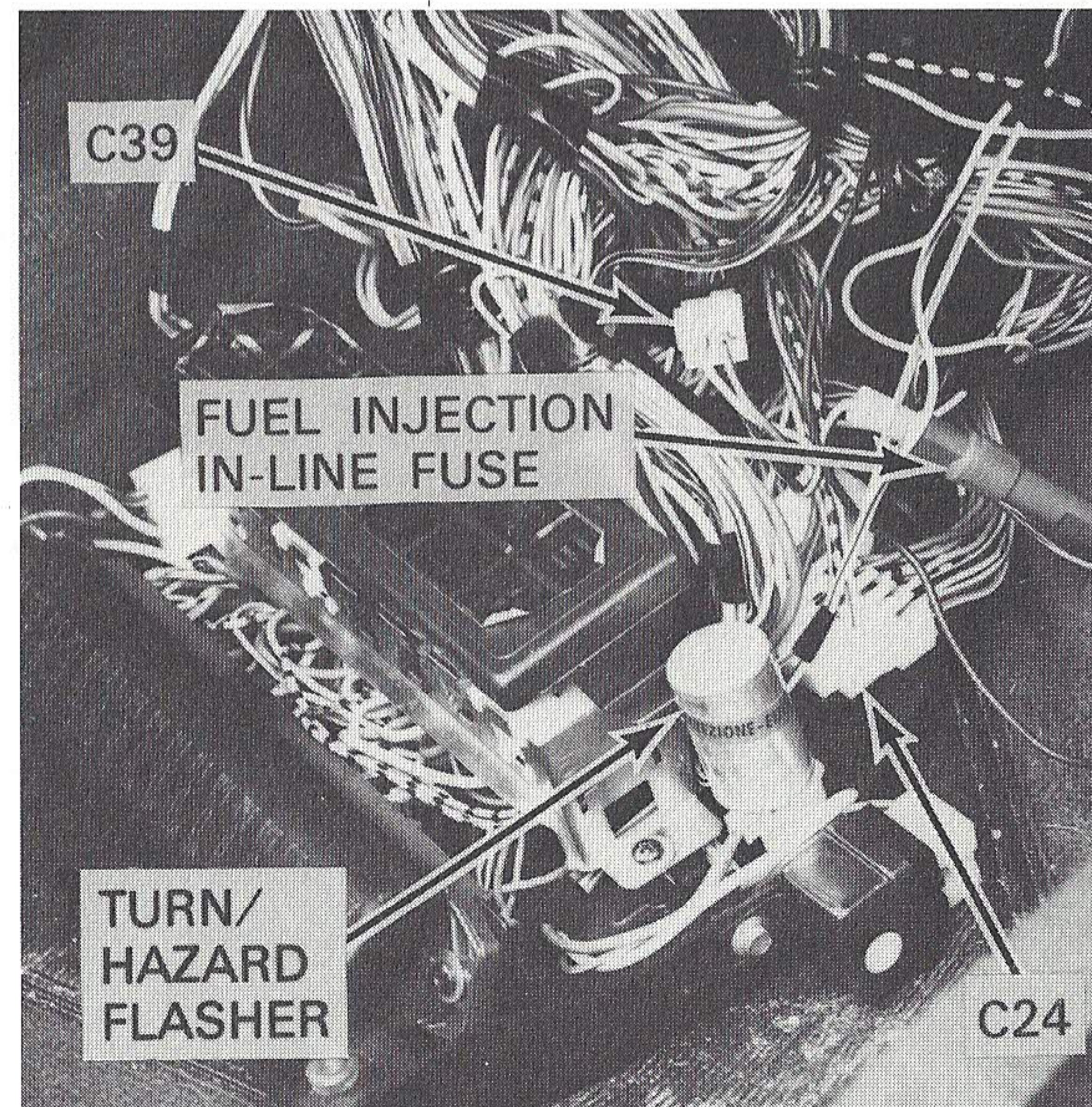

Figure 1 - Top RH Side of Relay Panel

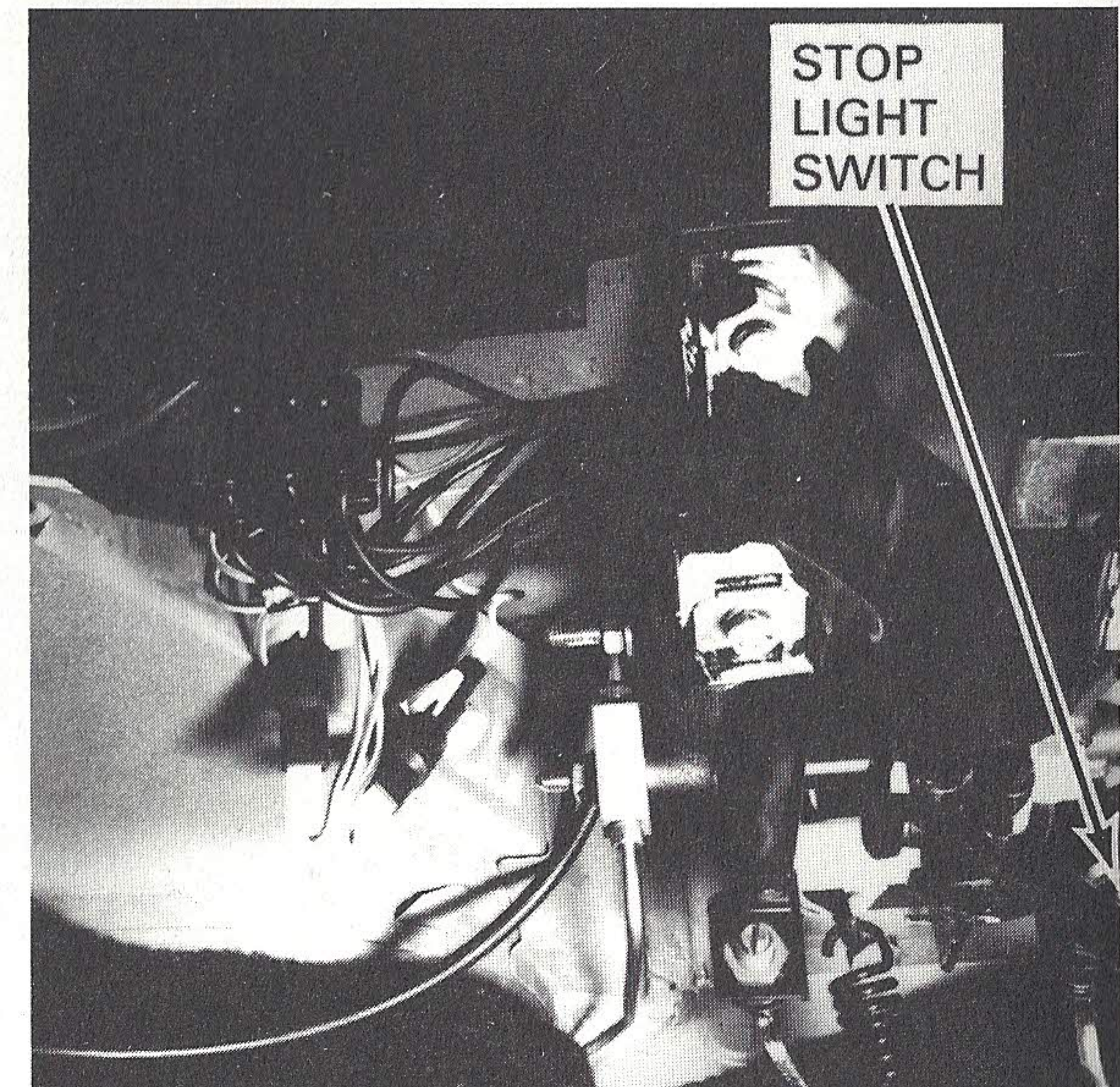

Figure 2 - Below LH Side of Dash Panel

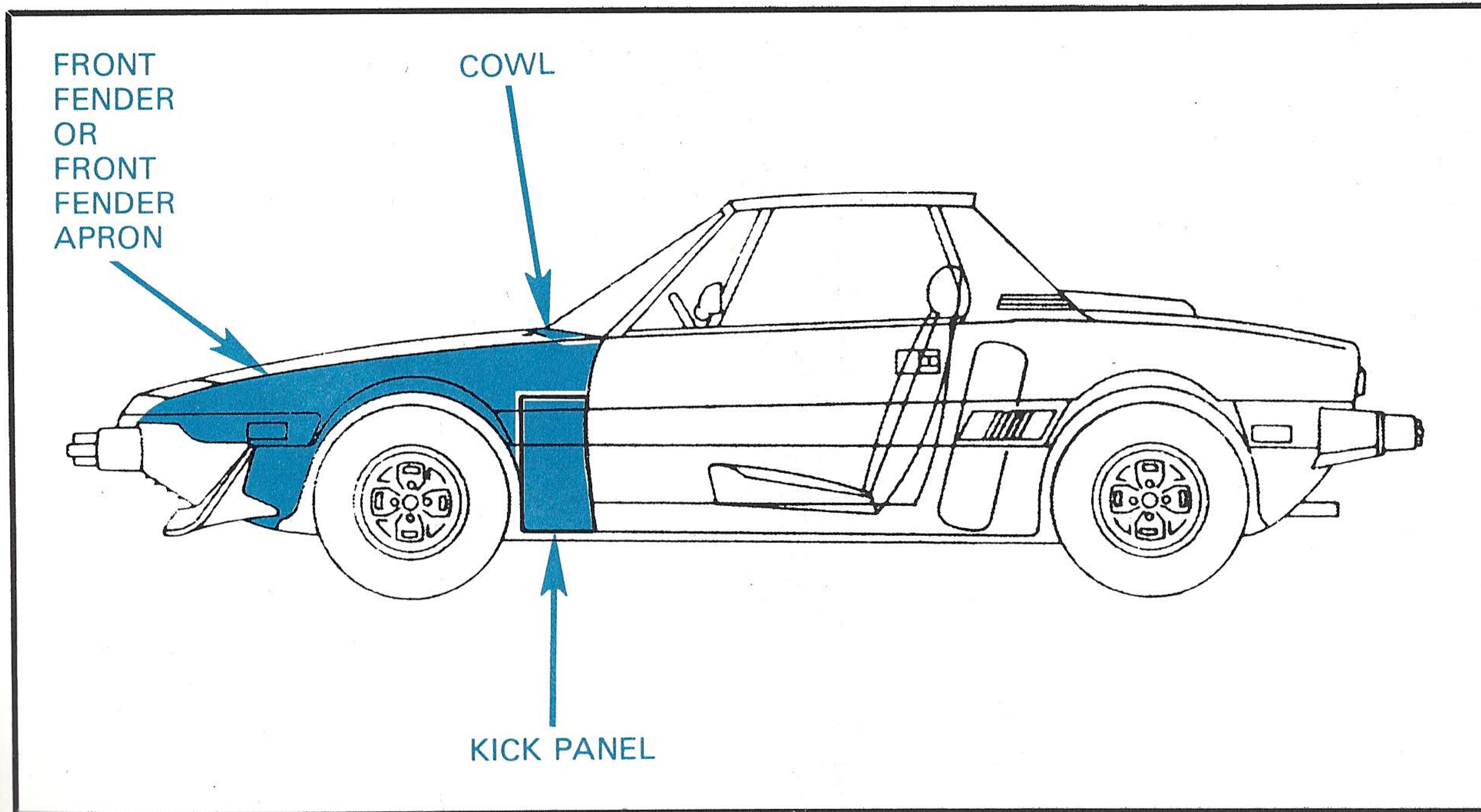

Figure 1 - Body Part Locations

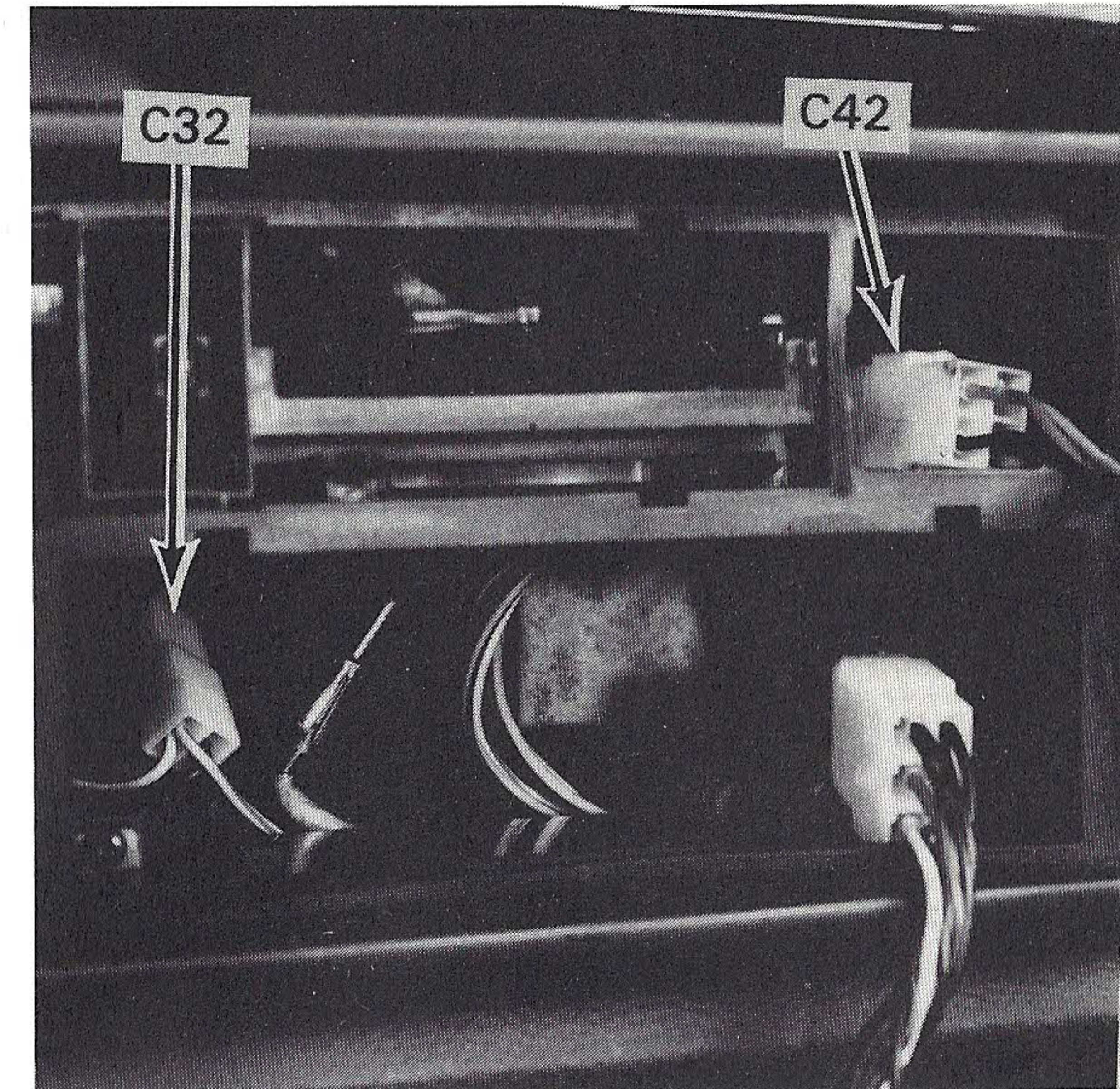

Figure 2 - Behind Center of Dash Panel

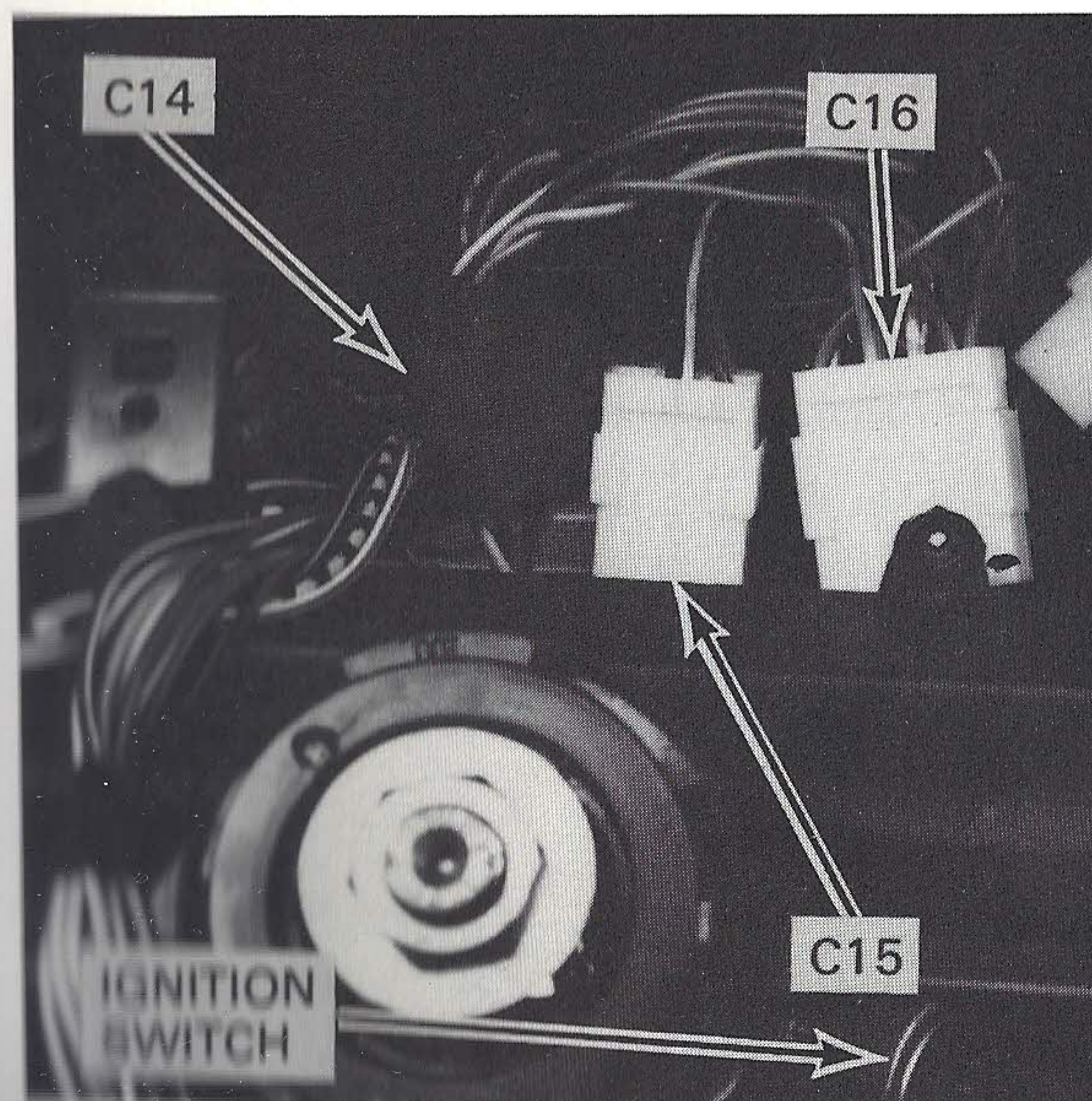

Figure 3 - Behind Instrument Cluster

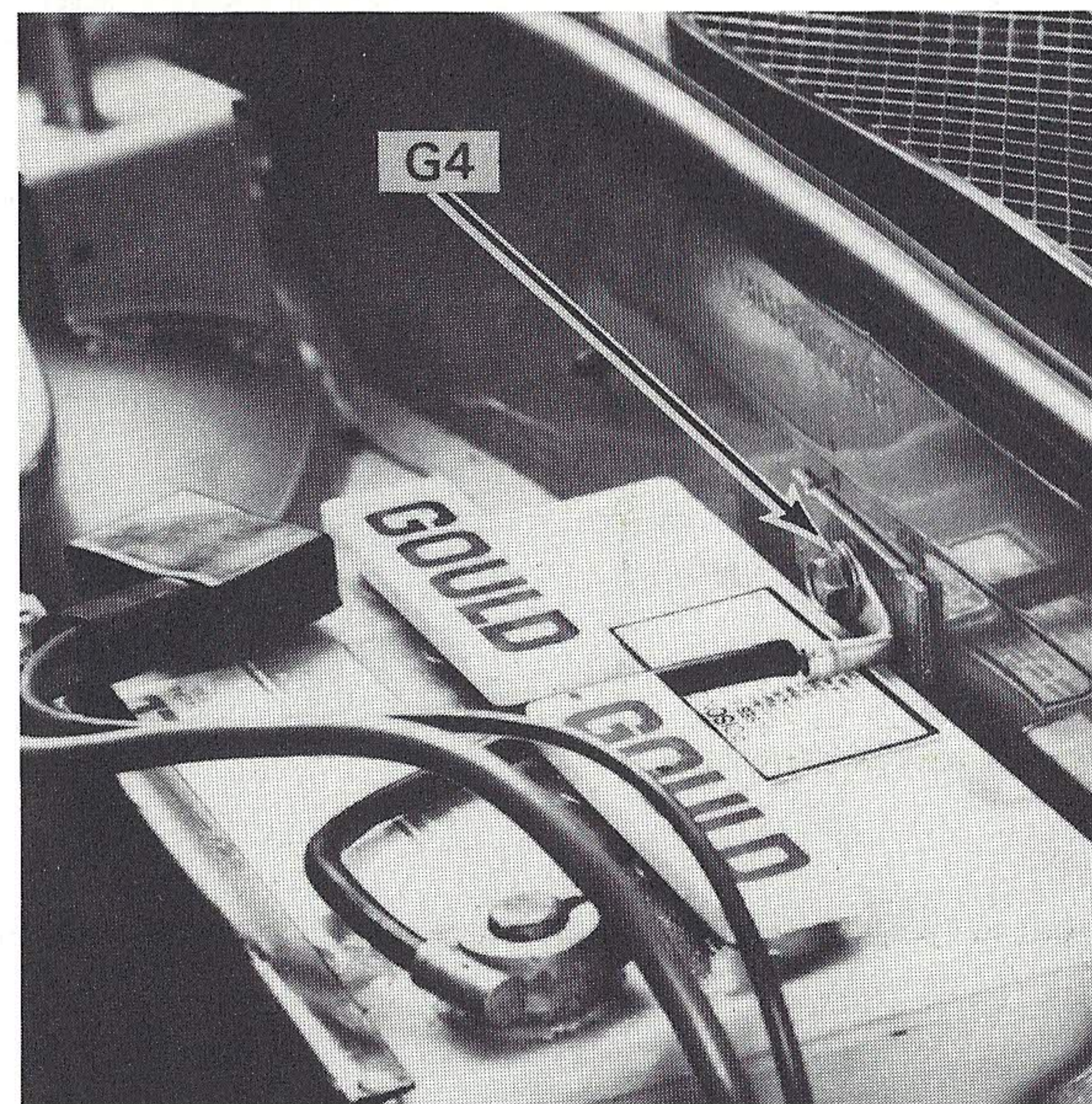

Figure 4 - Top of Battery

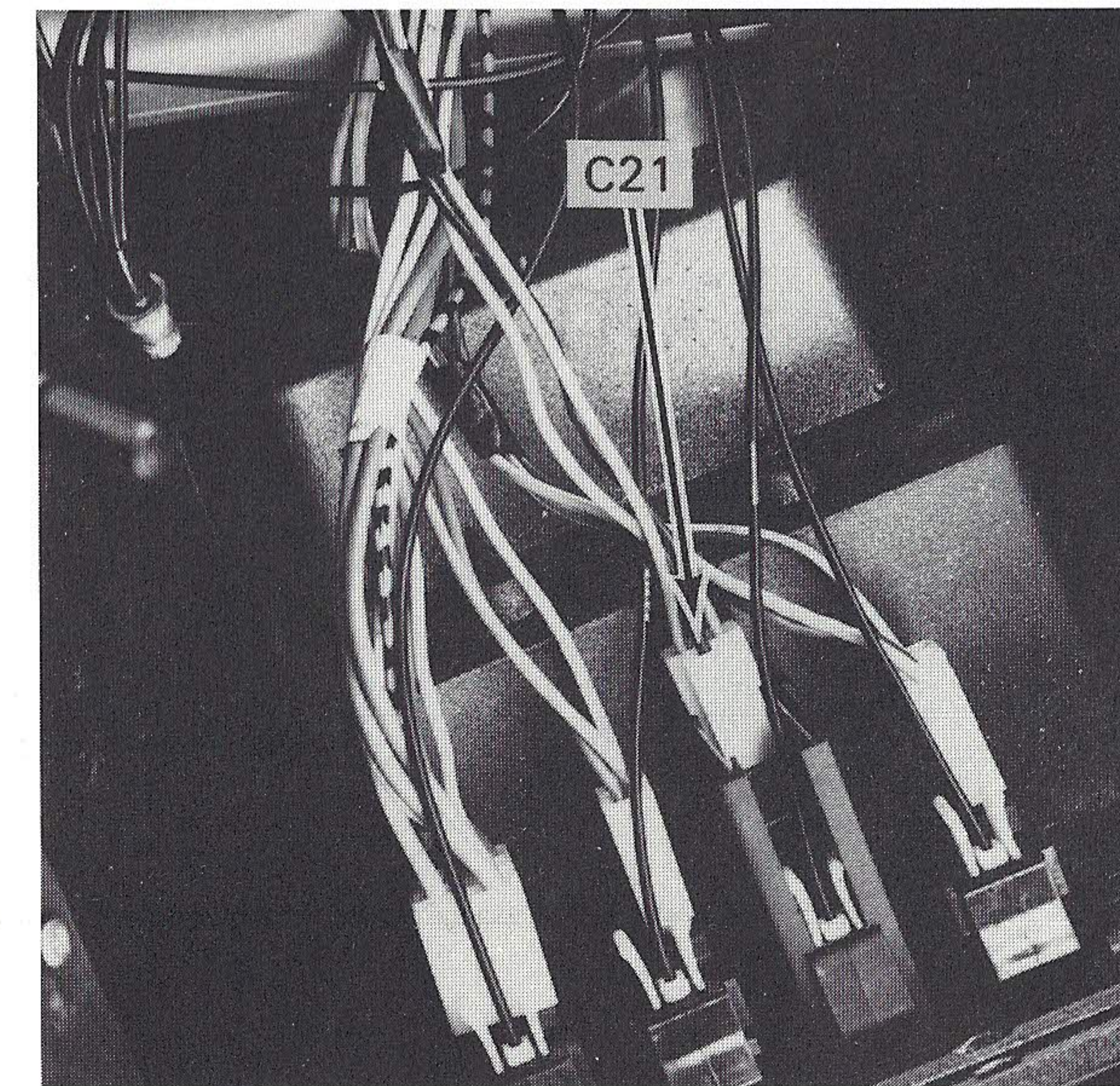
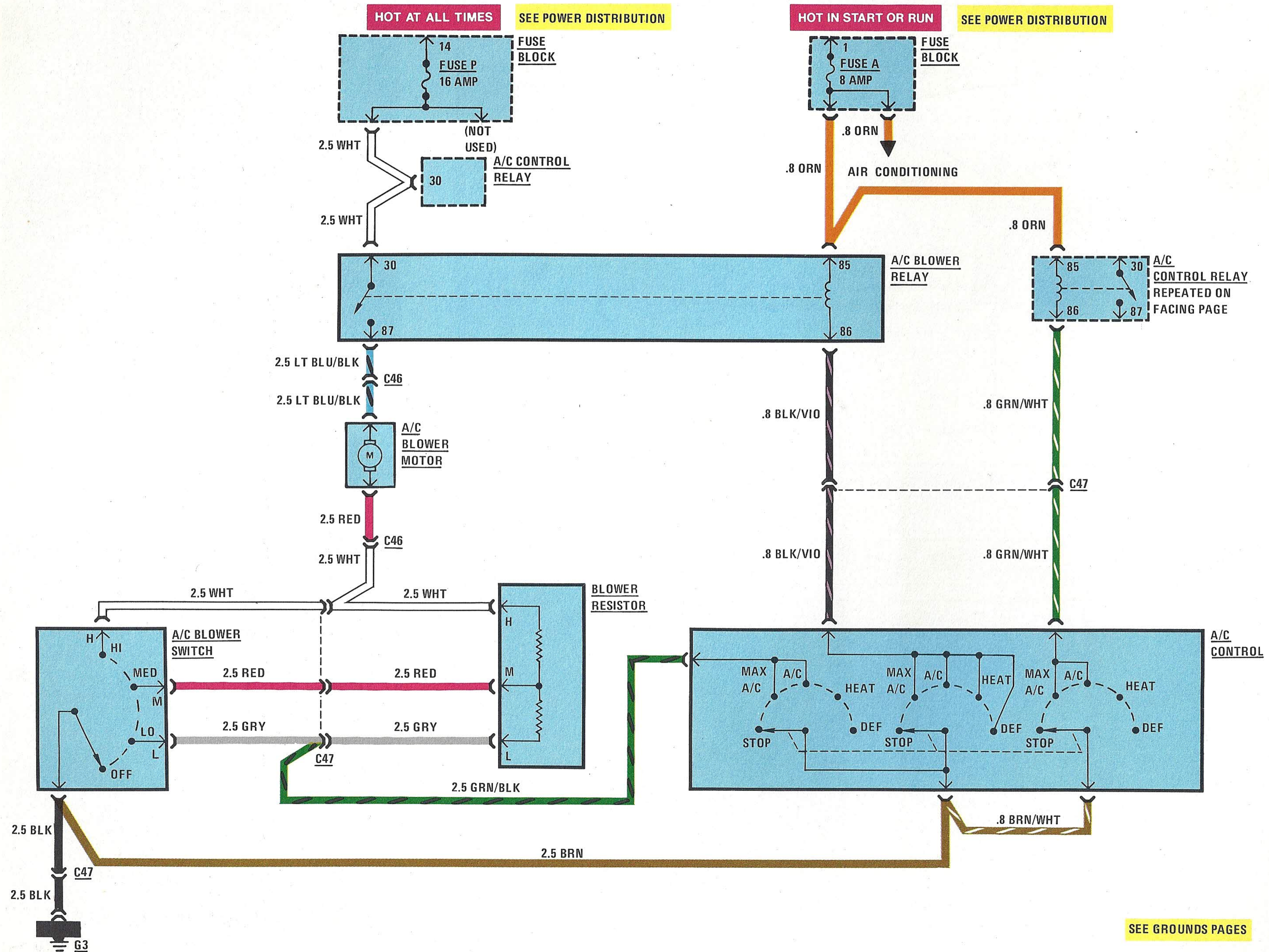

Figure 5 - Back of Center Console



SEE GROUNDS PAGES

CIRCUIT OPERATION

The driver controls operation of the Air Conditioning System with the A/C CONTROL. With the IGNITION SWITCH in "Start" or "Run," voltage is applied through FUSE A, the A/C BLOWER RELAY coil, and the BLK/VIO wire to the A/C CONTROL.

Blower Motor

With the A/C CONTROL in "Heat" or "Def," current flows through the BRN wire to G3. This grounds the A/C BLOWER RELAY coil and closes the relay contacts. Voltage is then applied through A/C BLOWER RELAY terminals 30 and 87, the A/C BLOWER MOTOR, RED and WHT wires to the A/C BLOWER SWITCH. If the switch is in "Off," the motor does not run because the current cannot flow to ground. With the SWITCH in "Lo," current flows through C47, the WHT wire, both resistors, C47, the GRY wire and switch to G3. With the switch in "Med," current flows through C47, the WHT wire, one resistor, C47, the RED wire and switch to G3. With the switch in "Hi," current flows directly from the blower motor through the switch to G3.

With the A/C CONTROL in "Max A/C" or "A/C," blower motor operation is the same as above if the A/C BLOWER SWITCH is in Lo," "Med," or "Hi." If the A/C BLOWER SWITCH is in "Off," however, the "Max A/C" and "A/C" positions operate the MOTOR in spite of the SWITCH position. This helps keep the evaporator core from freezing up. Current flows through the motor, the RED and WHT wires, both blower resistors, the GRY and GRN/BLK wires, the A/C CONTROL, the BRN wire, and to G3.

COMPONENT LOCATION

| | | Page-Figure |
|-------------------------------|---|-------------|
| A/C Blower Motor | Behind dash panel in heat/cool unit | |
| A/C Blower Relay | Attached to relay panel..... | 64-1 |
| A/C Blower Switch | Center of dash panel | |
| A/C Control..... | Center of dash panel | |
| A/C Control Relay | Attached to relay panel..... | 64-1 |
| A/C Electrovalve..... | Attached to air flow sensor..... | 63-2 |
| A/C Frost Prevent Switch ... | Mounted on A/C line at heat/cool unit..... | 67-2 |
| A/C High Pressure Switch... | Attached to A/C line to receiver/drier..... | 63-1 |
| A/C Frost Prevent Valve | Front lower LH engine compartment | 67-1 |
| A/C Pressure Switch..... | In A/C line below air cleaner..... | 67-3 |
| Blower Resistor | Rear LH side of front luggage compartment | 63-3 |
| Compressor Clutch | Lower RH rear of engine | |
| Condenser Fan Motor | Behind condenser fan | |
| Condenser Fan Relay | Attached to relay panel..... | 64-1 |
| Condenser Fan Thermoswitch | Attached to line to receiver/drier | 63-3 |
| Fuse Block | Attached to top rear of relay panel | 64-1 |
| C23 (2 cavities) | Above relay panel | 67-4 |
| C29 (2 cavities)..... | Below air cleaner..... | 67-3 |
| C45 (1 cavity)..... | Engine compartment rear RH firewall | |
| C46 (2 cavities)..... | In front of relay panel..... | 67-2 |
| C47 (6 cavities)..... | Behind A/C control panel | 67-5 |
| C48 (2 cavities)..... | Front of receiver/drier..... | 63-1 |
| C49 (2 cavities)..... | Behind condenser fan motor | |
| C50 (2 cavities)..... | Front of receiver/drier..... | 63-1 |
| G11..... | Attached to air flow sensor mounting bracket. ... | 63-2 |
| G3..... | Under dash panel, to left of steering column | |

A/C Compressor Clutch

Voltage is applied at all times through FUSE 14 to terminal 30 of the A/C CONTROL RELAY. With the IGNITION SWITCH in "Start" or "Run," and the A/C CONTROL in "Max A/C" or "A/C," current flows through FUSE A, the A/C CONTROL RELAY coil, GRN/WHT wire, and BRN wire to G3. The A/C CONTROL RELAY contacts close. Current then flows through terminals 30 and 87, the A/C PRESSURE SWITCH, and the COM-

PRESSOR CLUTCH (to ground). This current also flows through the A/C ELECTROVALVE to G1. The electrovalve compensates for the COMPRESSOR CLUTCH load on the engine.

This circuit also includes an A/C FROST PREVENT VALVE. When voltage is available through C48, it is applied to the A/C FROST PREVENT SWITCH and to the A/C HIGH PRESSURE SWITCH. If either of these switches is closed, current flows through the LT BLU/WHT wires to

energize the A/C FROST PREVENT VALVE. In "Start" or "Run", voltage is applied through the coil of the CONDENSER FAN RELAY and the BLK wire to the CONDENSER FAN THERMOSWITCH. When this switch is closed, current flows through the CONDENSER FAN RELAY coil, the switch, and to G1. The relay contacts close and current flows through FUSE 12, terminals 30 and 87 of the relay, and the CONDENSER FAN MOTOR to G1. The motor operates as long as the CONDENSER FAN THERMOSWITCH contacts are closed.

TROUBLESHOOTING

Blower Motor

IF A/C BLOWER MOTOR DOESN'T WORK IN ANY SPEED:

- Check FUSE A by operating HEATER FAN.
- Check A/C BLOWER RELAY by removing relay and inserting shorting wire into cavities 30 and 87.

IF A/C BLOWER RELAY WORKS IN "HI" BUT NOT IN "OFF," "LO," OR "MED":

- Check A/C BLOWER RESISTORS.
- Check A/C BLOWER SWITCH.

A/C Compressor Clutch

IF COMPRESSOR CLUTCH DOES NOT OPERATE WHILE BLOWER RUNS NORMALLY:

- Check A/C CONTROL RELAY by removing it and inserting a shorting wire into cavities 30 and 87.
- Check A/C PRESSURE SWITCH for continuity.

IF COMPRESSOR CLUTCH OPERATES BUT A/C SYSTEM FAILS TO COOL:

- Check A/C FROST PREVENT SWITCH and A/C HIGH PRESSURE SWITCH by disconnecting them one at a time.

IF CONDENSER FAN DOES NOT RUN:

- Check CONDENSER FAN RELAY by removing it and inserting a shorting wire in cavities 30 and 87.
- Check CONDENSER FAN THERMOSWITCH by removing the SWITCH and inserting a shorting wire in its place.

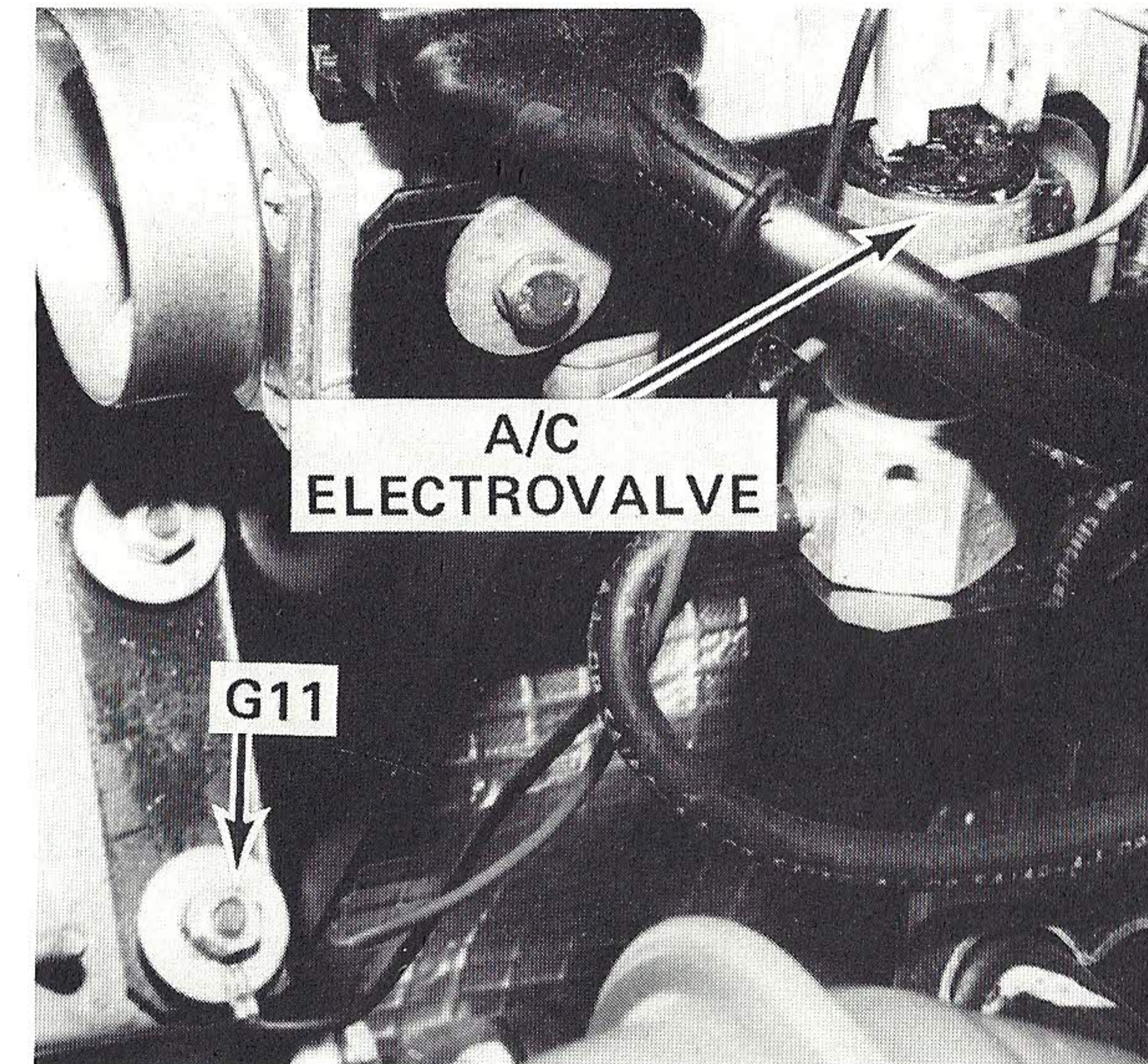

Figure 2 — LH Side Engine Compartment

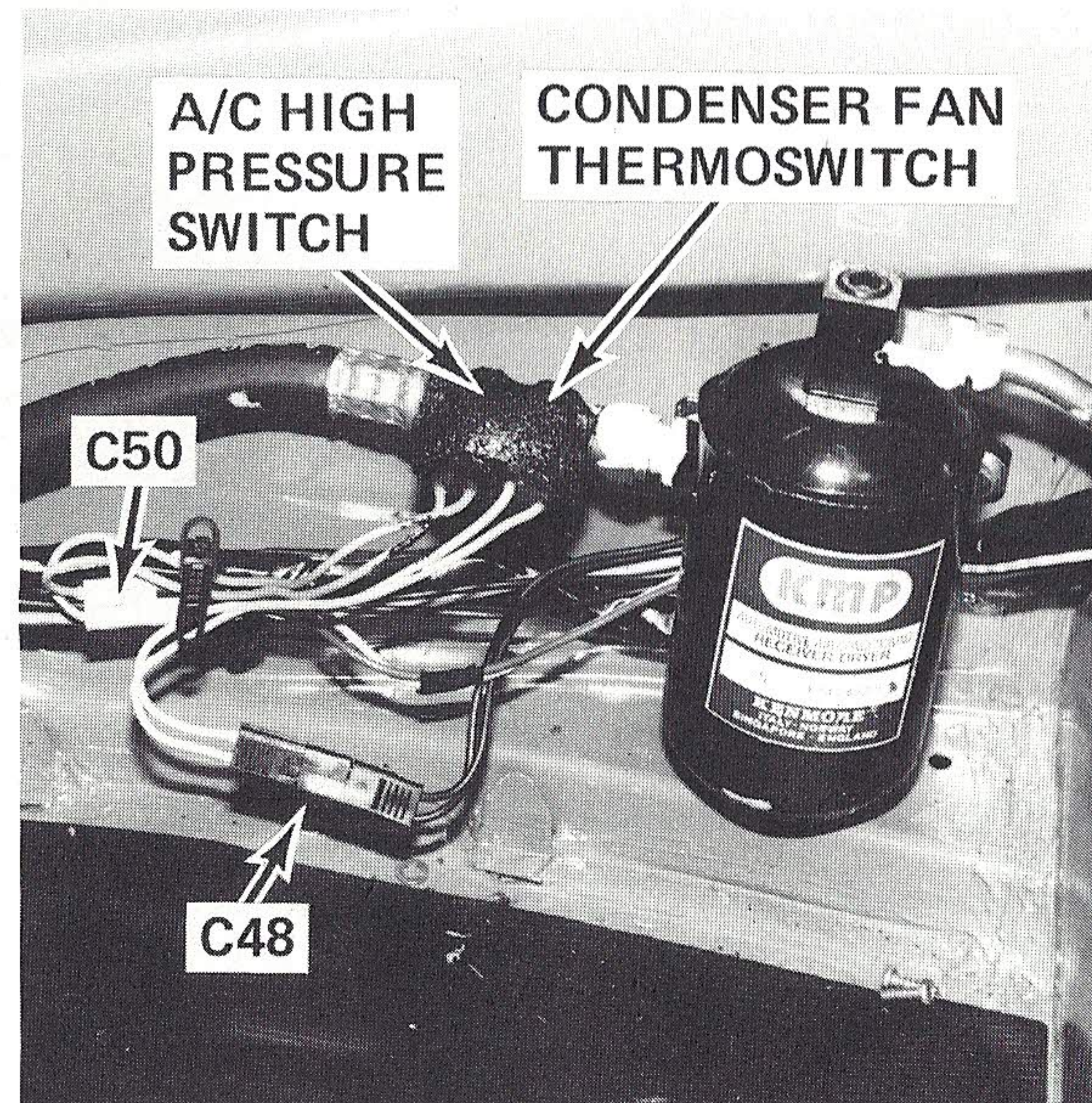

Figure 1 — RH Front Luggage Compartment

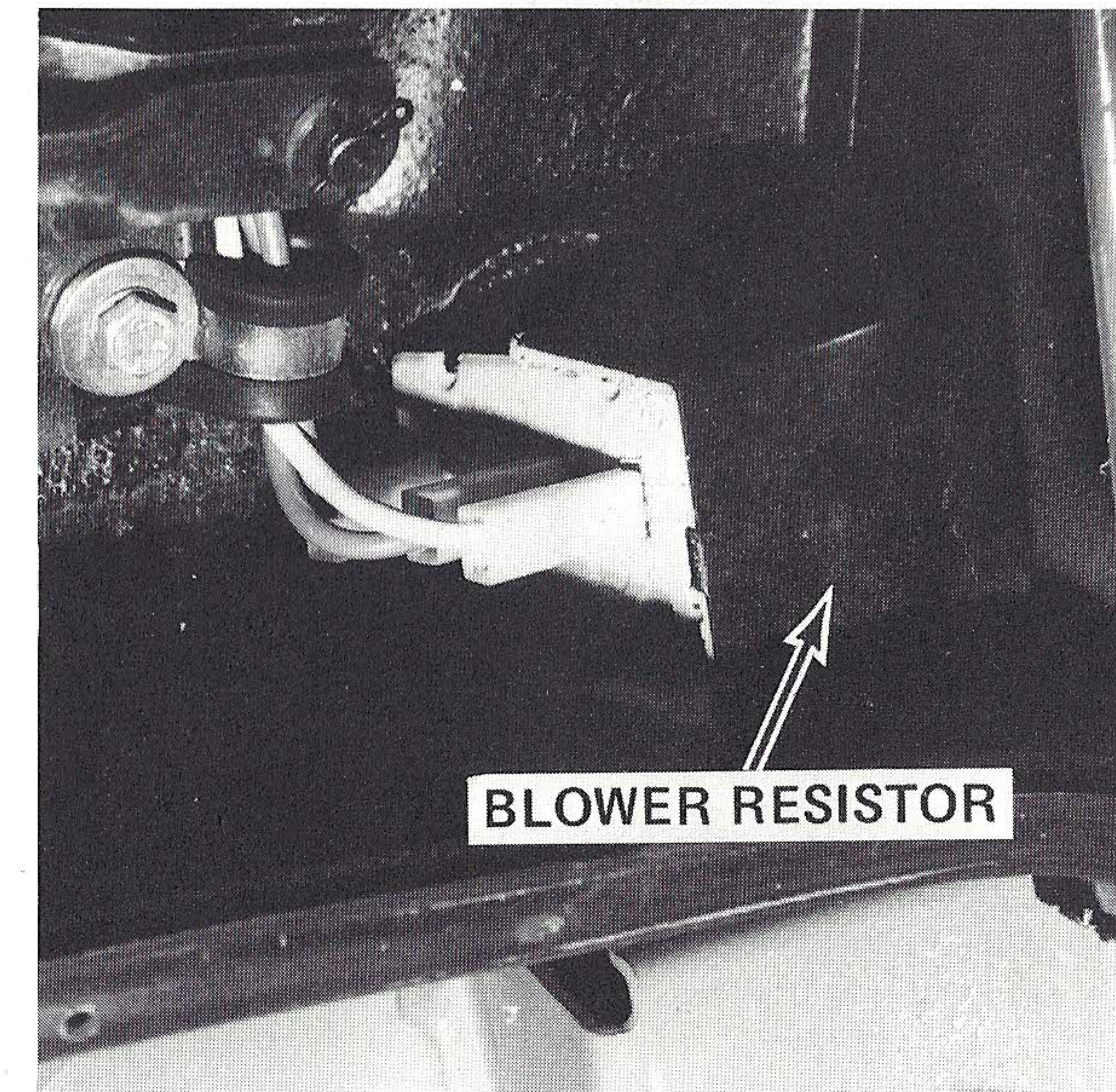

Figure 3 — LH Rear of Front Luggage Compartment

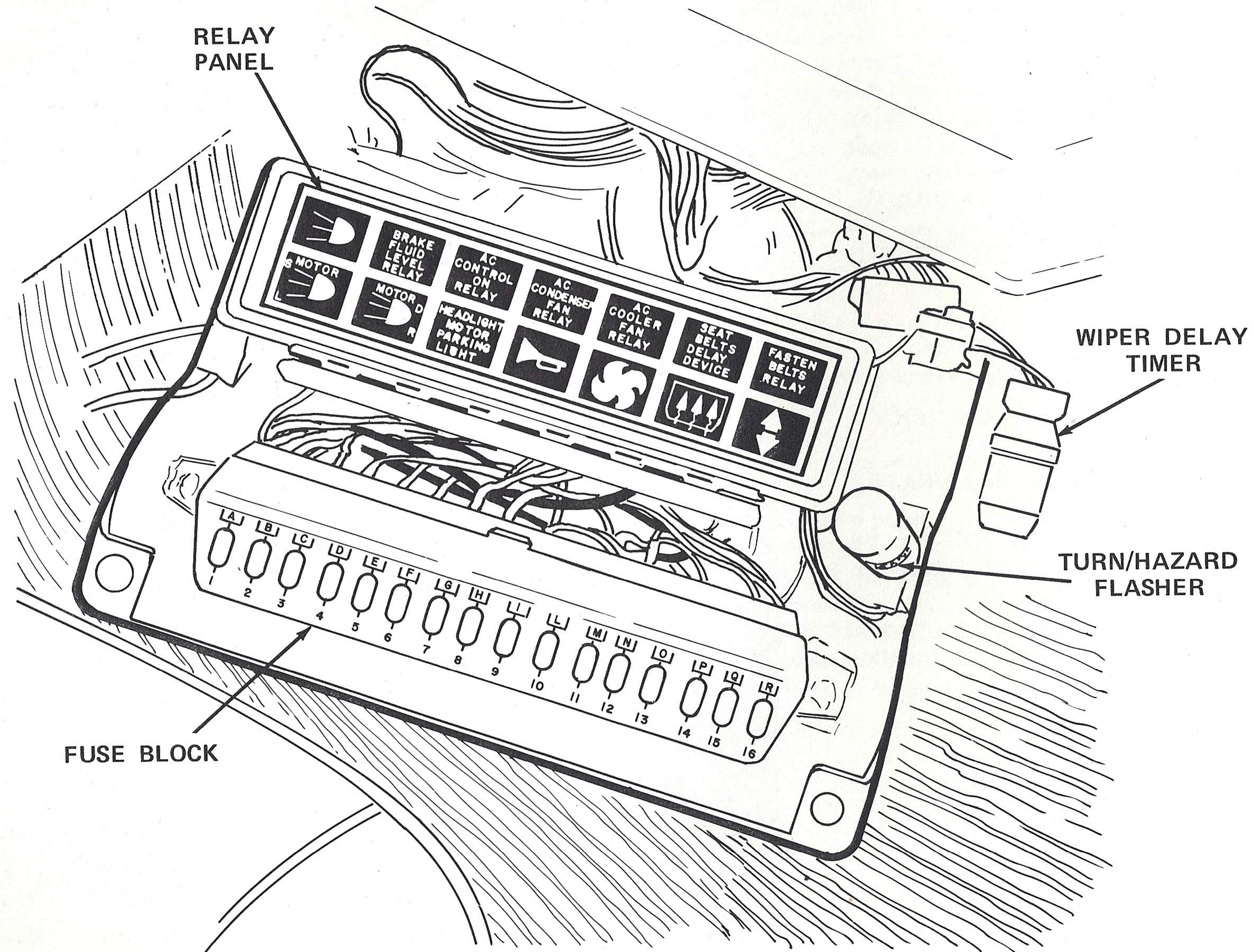
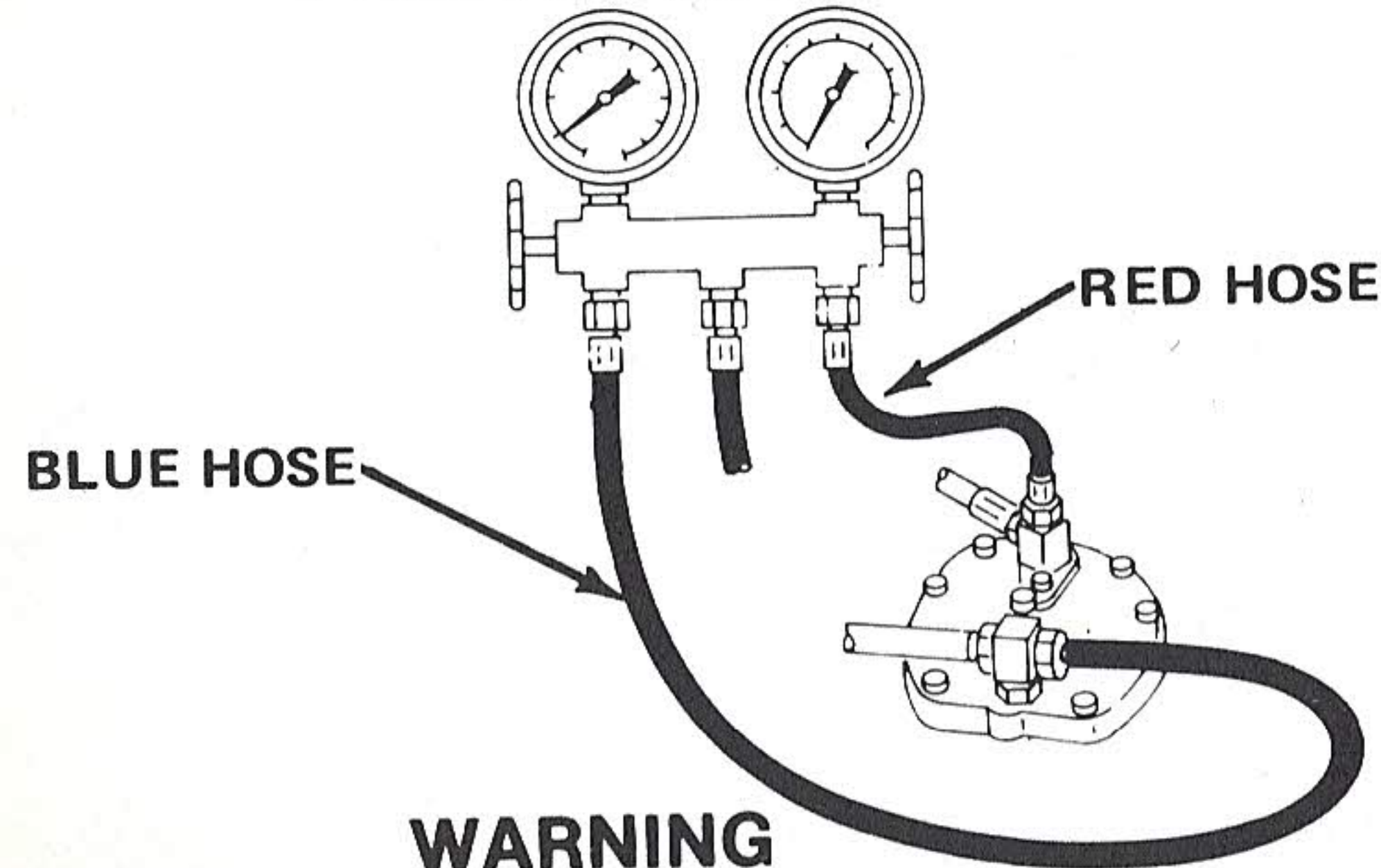

Figure 1 - Fuse Block And Relay Panel

PREPARATION



WARNING

Make sure there is adequate ventilation. Do not discharge refrigerant near open flame. A toxic gas may result. Always wear eye goggles to protect your eyes.

Close both valves on A/C manifold. Remove caps from service fittings on compressor and/or isobaric valve.

Connect red hose (high pressure) to discharge fitting on compressor. Connect blue hose (low pressure) to suction (low pressure) fitting on isobaric valve, or on compressor.

Provide fan to blow air over front of car during checks.

NOTE

Pressure readings will vary according to ambient temperatures, relative humidity, and atmospheric pressure.

NORMAL SYSTEM CHECK

7-42 PSI

142-284 PSI

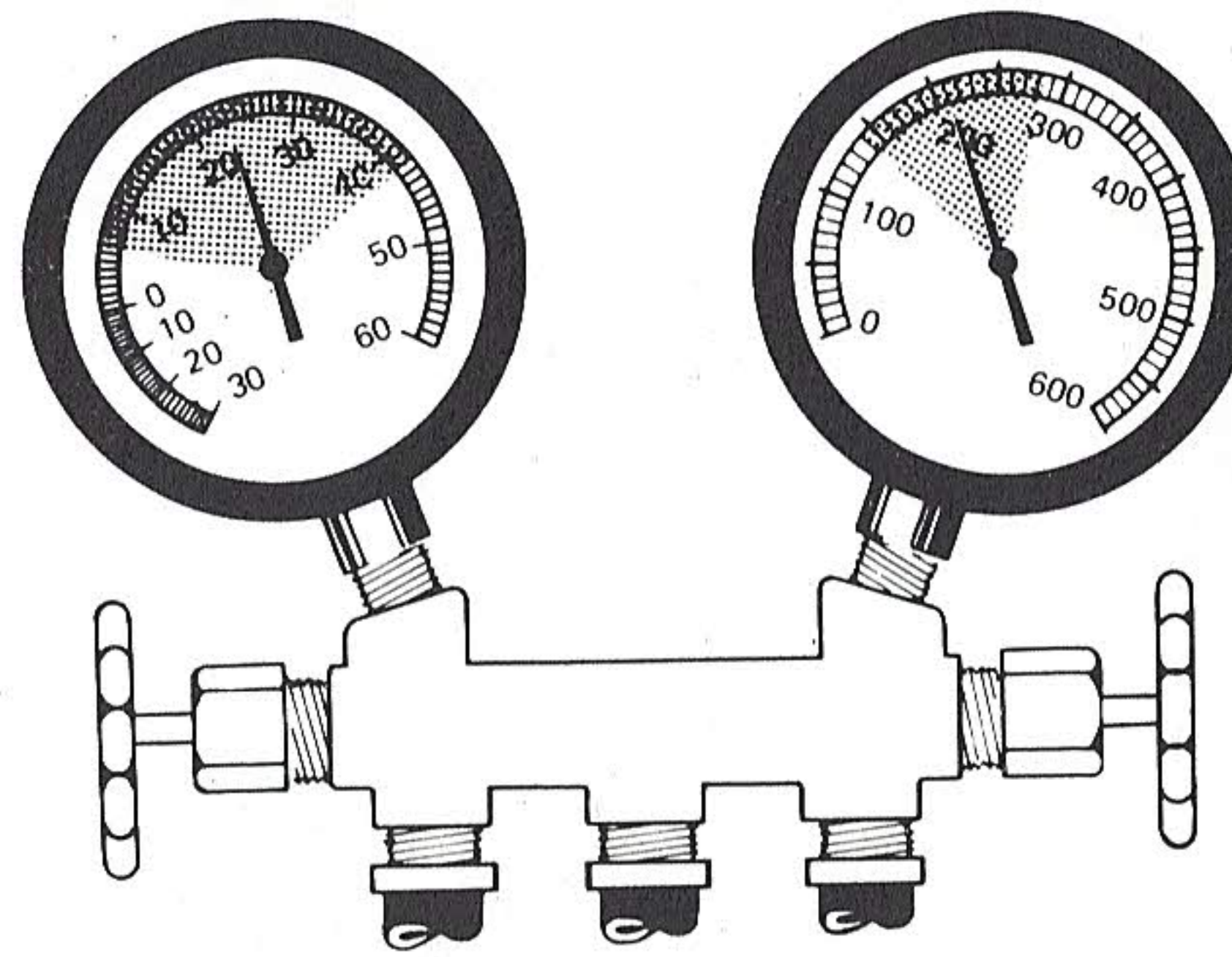

Obtain a thermometer. Place thermometer in right center air outlet about 1 1/4 inches. Note reading on thermometer.

Check that both gauges on manifold read about 70 psi at 70°F. Set controls for maximum air conditioning. Start engine and run at 700 to 800 rpm.

After 2 minutes note reading on thermometer. Reading should be at least 8°C (14°F) lower than previous reading. Check that low pressure gauge reads between 7 and 42 psi and the high pressure gauge between 142 and 284 psi.

MINIMUM PRESSURE SWITCH CHECK

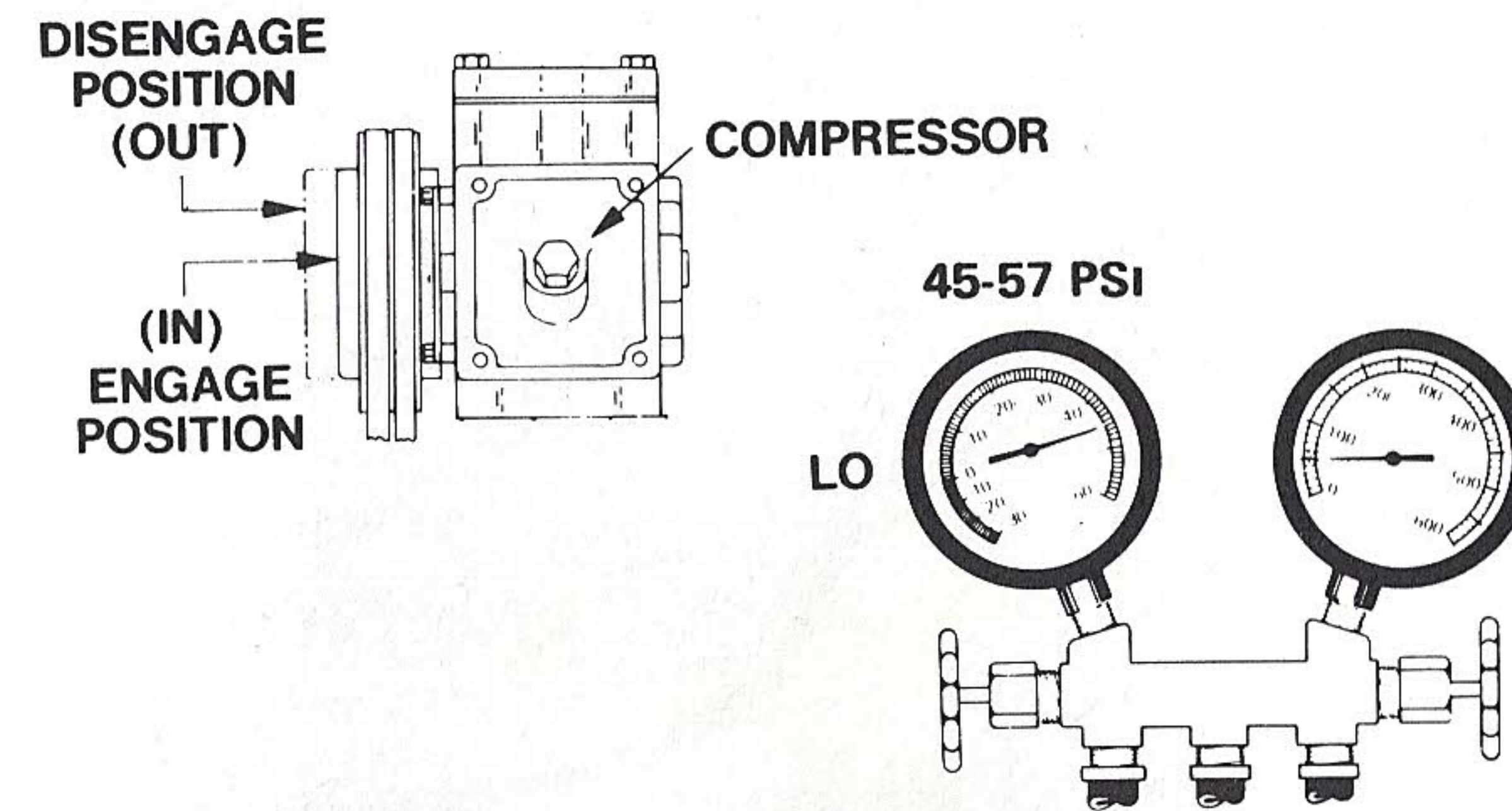

With engine not running, heater/A.C. fan switch ON, and ignition switch to ON, have someone turn the temperature control knob full clockwise, and counter clockwise a few times. Check that the compressor clutch engages and disengages.

Set fan switch and temperature control knob to maximum. Open low pressure valve on manifold. Bleed refrigerant charge until clutch disengages between 45 and 57 psi on low pressure gauge.

Close low pressure valve. Recharge system.

CONDENSER FAN SWITCH CHECK

ABOUT 310 PSI

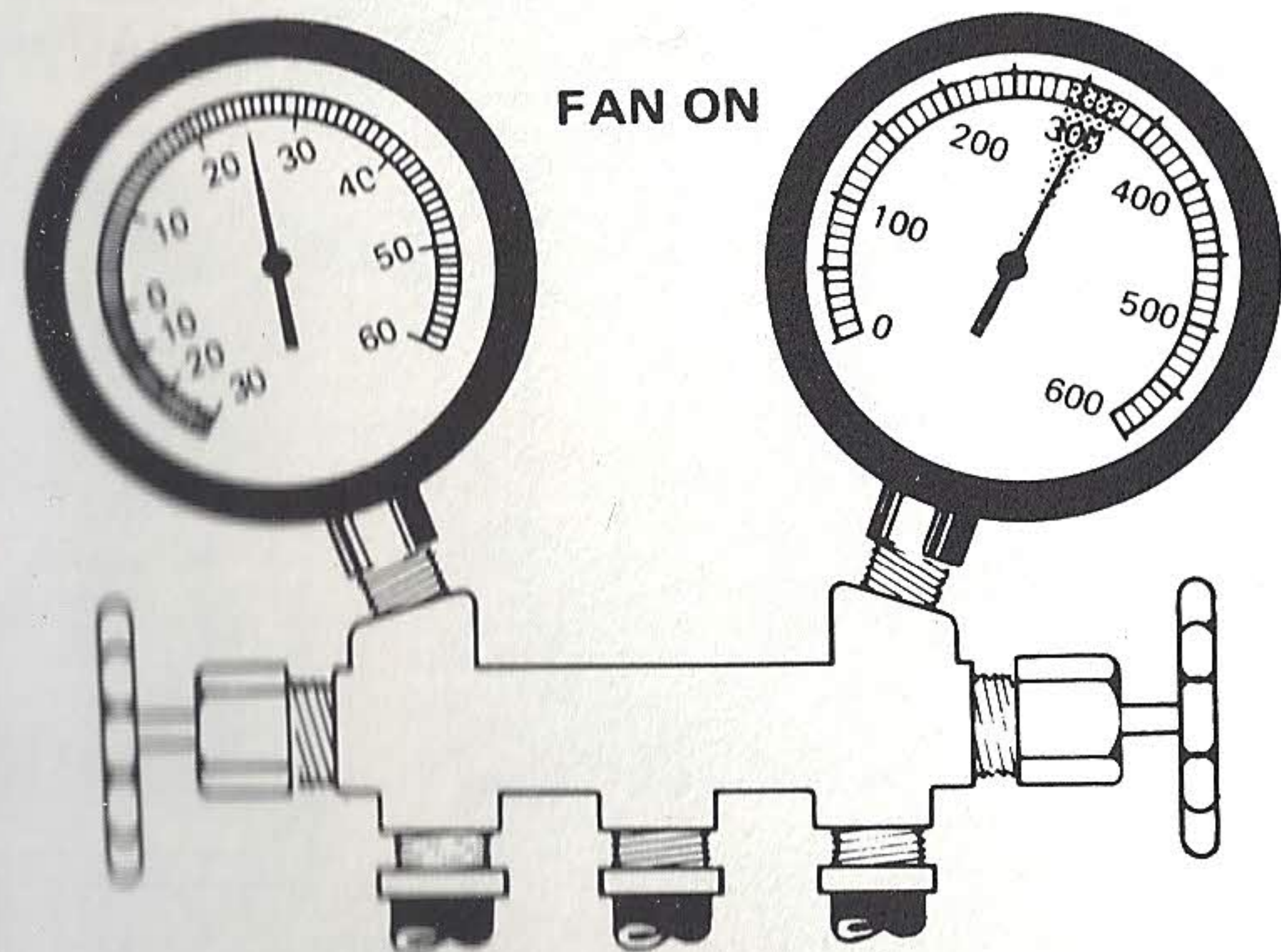

Do not use fan in front of car unless ambient temperature is over 80°F.

Start engine and run at 2000 rpm. Set controls for maximum air conditioning.

Check that condenser fan comes on about 310 psi on high pressure gauge. This indicates that the switch closed.

EXPANSION VALVE CHECK

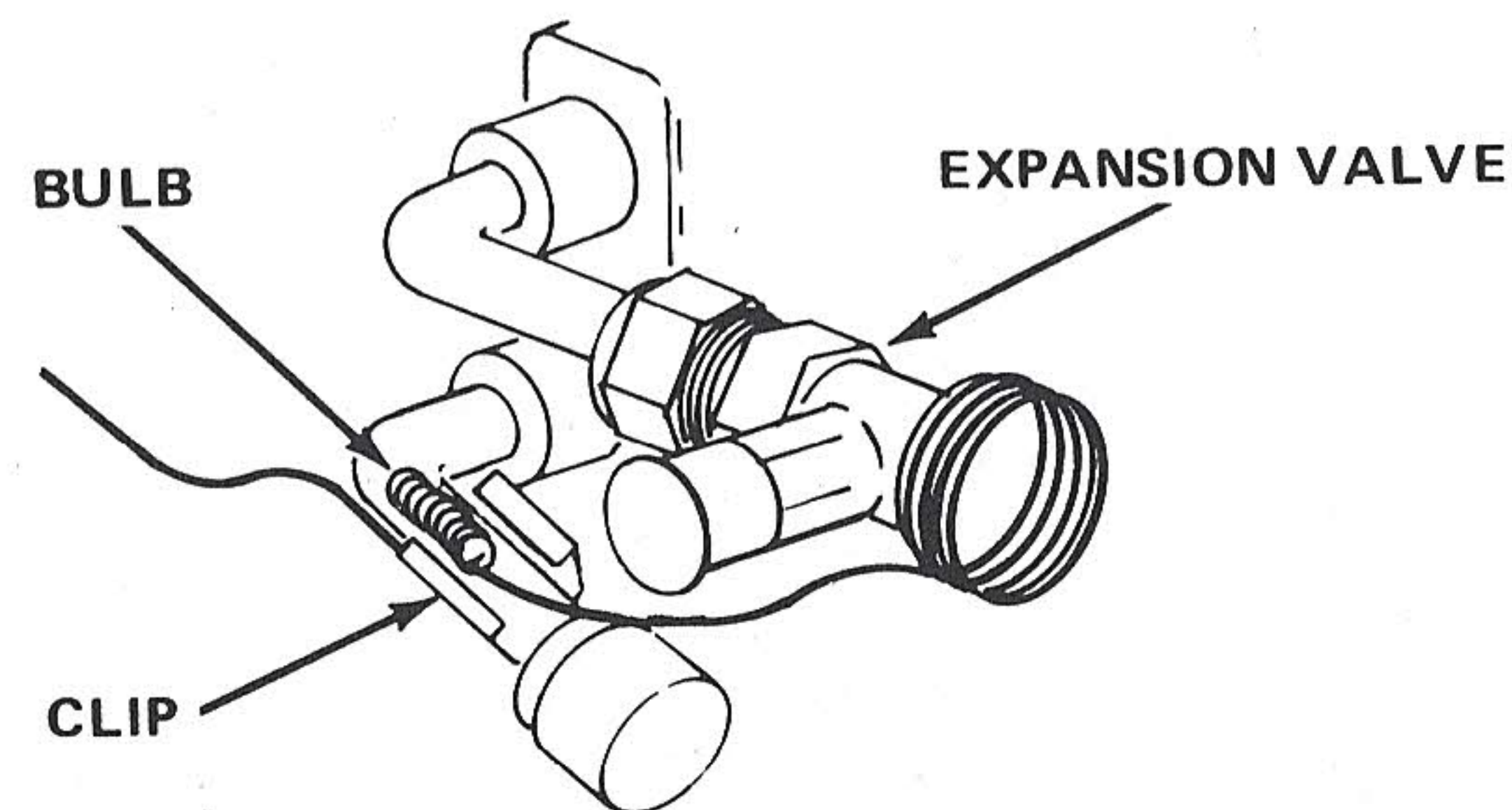

Run engine at 2000 rpm. Set controls for maximum air conditioning.

Remove insulation and retaining clip from expansion valve sensing bulb. Move bulb away from evaporator outlet pipe.

Using can of refrigerant, cool sensing bulb. Check that low pressure gauge reading starts decreasing.

The expansion valve is good if a progressive decrease of pressure to a vacuum reading is noted on low pressure gauge.

Heat sensing bulb with cigarette lighter. Check that the low pressure gauge increases to a reading higher than normal and that the high pressure gauge decreases.

TEMPERATURE CONTROL SWITCH CHECK

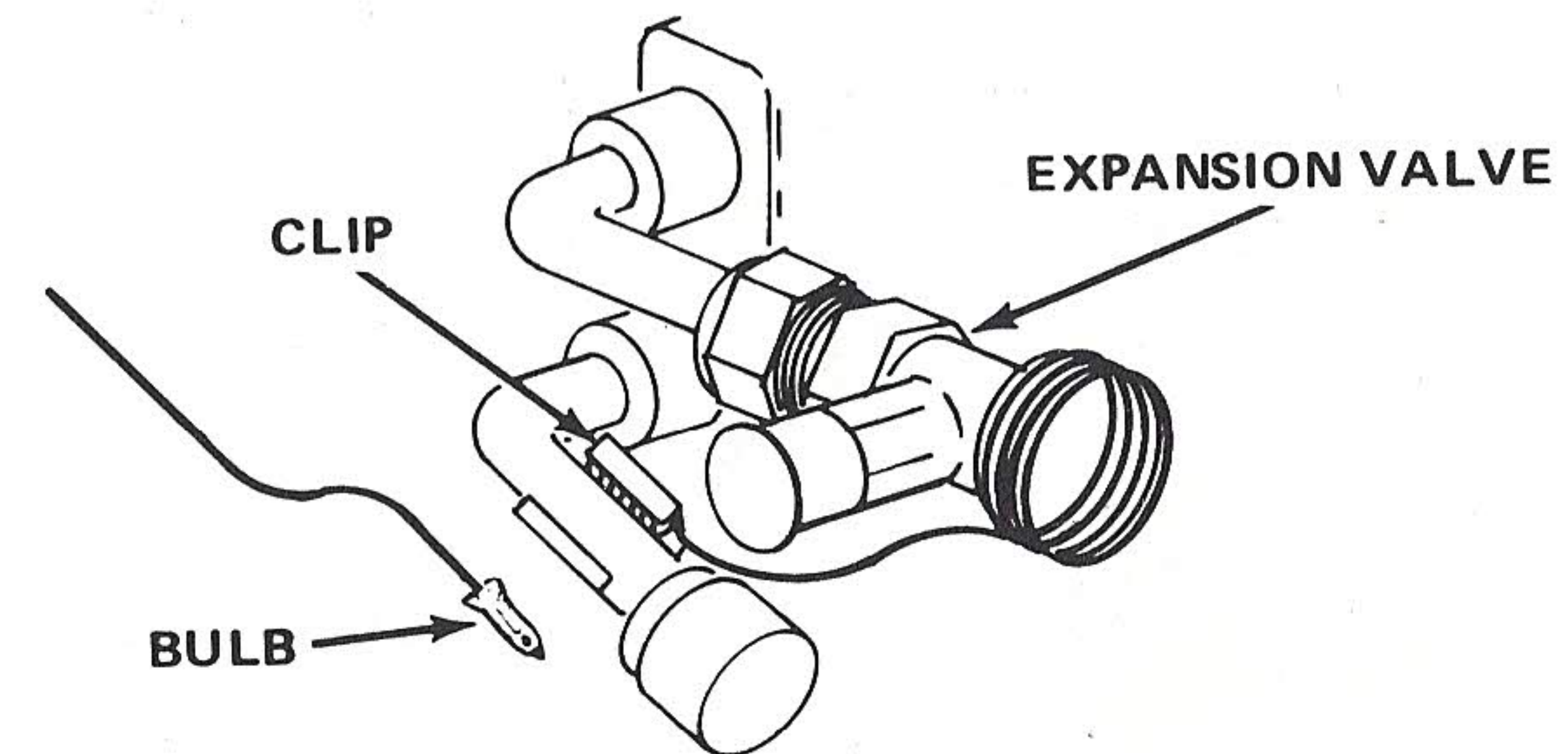

Set temperature control switch to low side of blue band. Check that compressor is engaged.

Using can of refrigerant, cool the sensing bulb of the temperature control switch. Check that the compressor disengages. Allow sensing bulb to heat up. Check that compressor engages.

Shut off engine and A/C system. Secure sensing bulbs with retaining clip. Cover bulbs with insulation.

Operate A/C system and check for complete charge by watching sight gauge. Remove A/C manifold.

SERVICING

PREPARATION

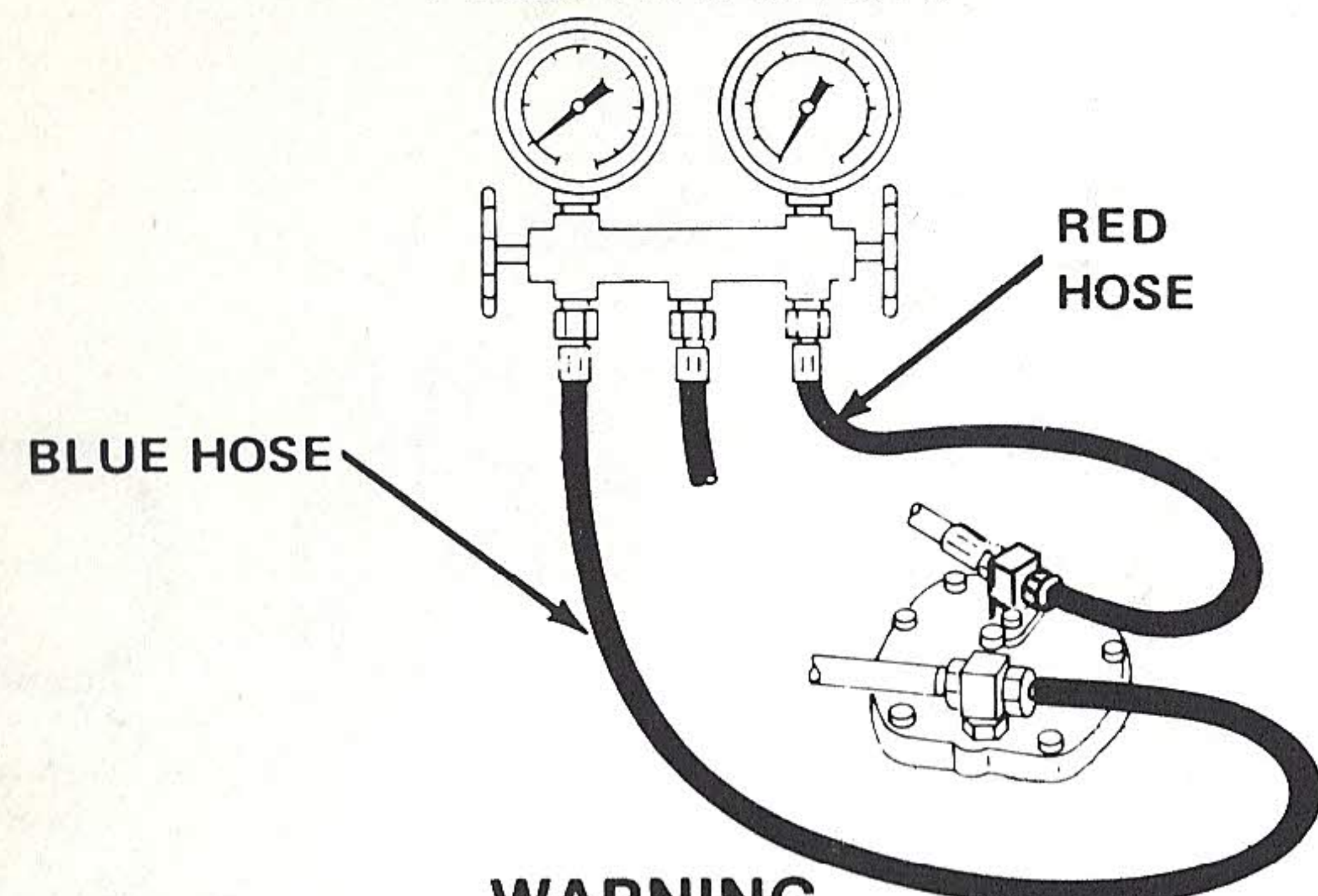

WARNING

Make sure there is adequate ventilation. Do not discharge refrigerant near open flame. A toxic gas may result. Wear eye goggles to protect your eyes.

NOTE

The suction (low pressure) service fitting is on either the isobaric valve or the compressor.

Close both valves on A/C manifold. Remove caps from service fittings. Connect red hose (high pressure) from manifold to discharge fitting on compressor. Connect blue hose (low pressure) to suction fitting on compressor.

PURGING

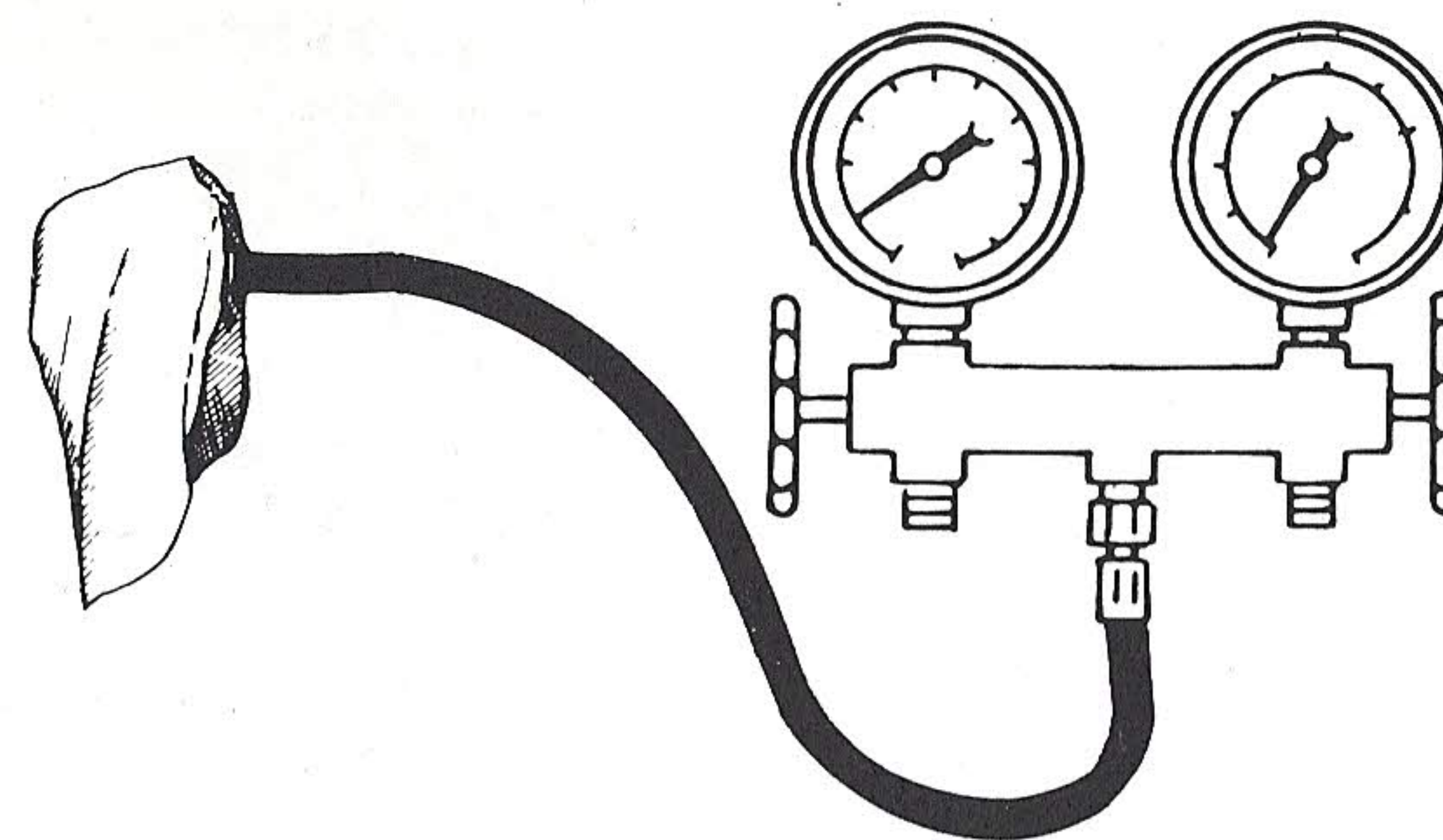

NOTE

The system must be evacuated anytime it is purged. Place yellow (middle) hose in clean rag. Slowly open both valves on manifold. Allow refrigerant to bleed off slowly.

CAUTION

Open valves only enough to bleed refrigerant slowly. Rapid bleeding will draw oil from compressor. Check rag for oil. Replace oil if drained out. When gauges read zero, system is purged. Close valves when refrigerant stops bleeding.

EVACUATING

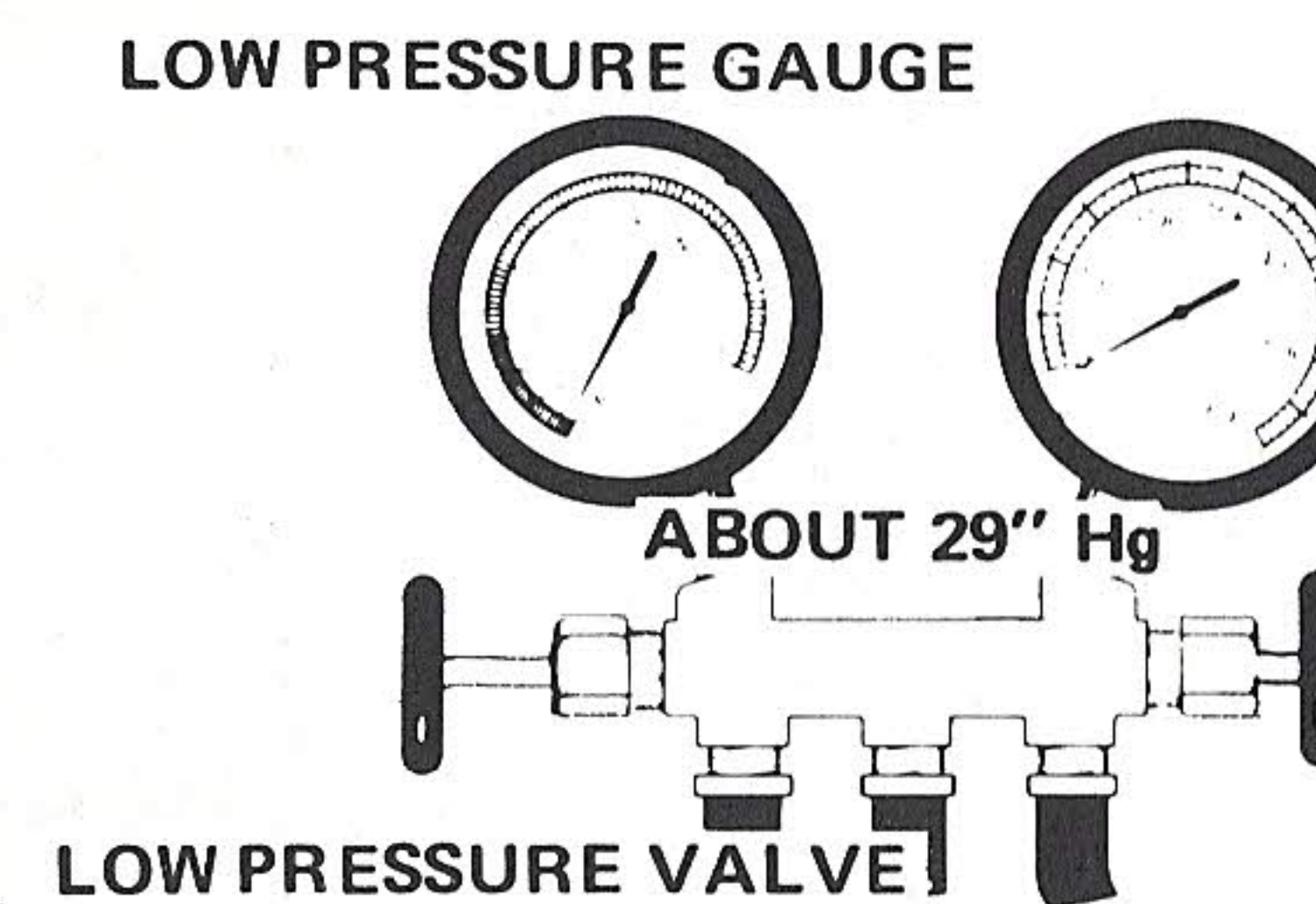

NOTE

System must not be running and must be purged before starting evacuation.

Remove caps from vacuum pump. Connect yellow hose to inlet of pump. Start pump. Open low pressure valve. Check that low pressure gauge reads slight vacuum.

After 5 minutes, check that low pressure gauge reads about 24" Hg and high pressure gauge reads slightly below zero.

Run pump for minimum of 45 minutes more. Check that low pressure gauge reads about 29" Hg. Close valve. Check that gauge does not rise faster than 1" Hg in 5 minutes.

Shut off pump. Disconnect pump.

CHARGING

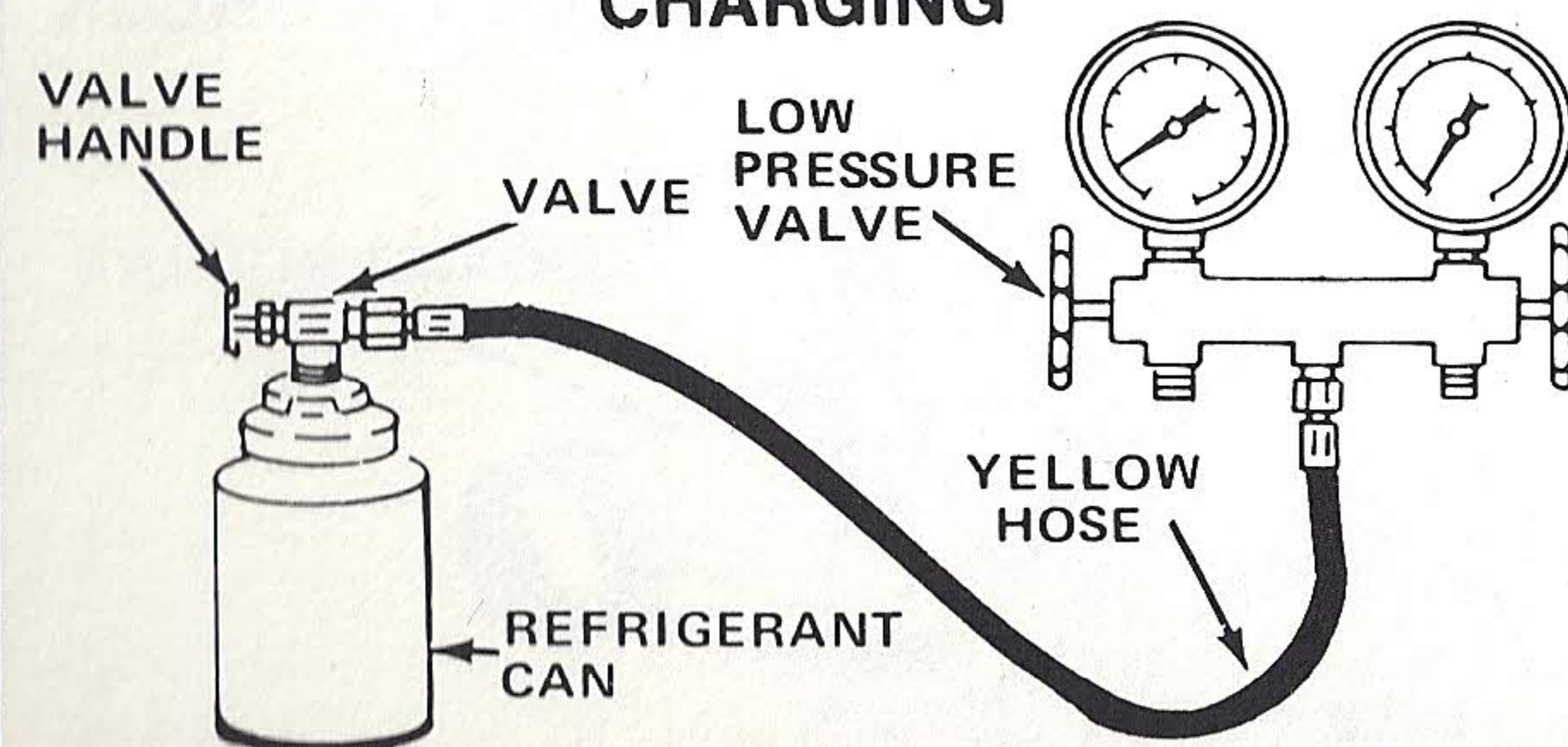

NOTE

System charge is about 2½ pounds. Close both valves on manifold.

Turn valve handle on can tap clockwise to close valve. Turn retaining plate down. Slip plate on can. Turn handle clockwise to pierce can. Turn handle all the way down.

Connect yellow (middle) hose to valve. Turn handle on valve all the way out (counter clockwise).

Loosen connection on yellow hose at manifold. Allow gas to escape for a few seconds. Tighten connection.

Open high pressure valve. Check that low pressure gauge comes out of vacuum into pressure. Close high pressure valve.

CHARGING

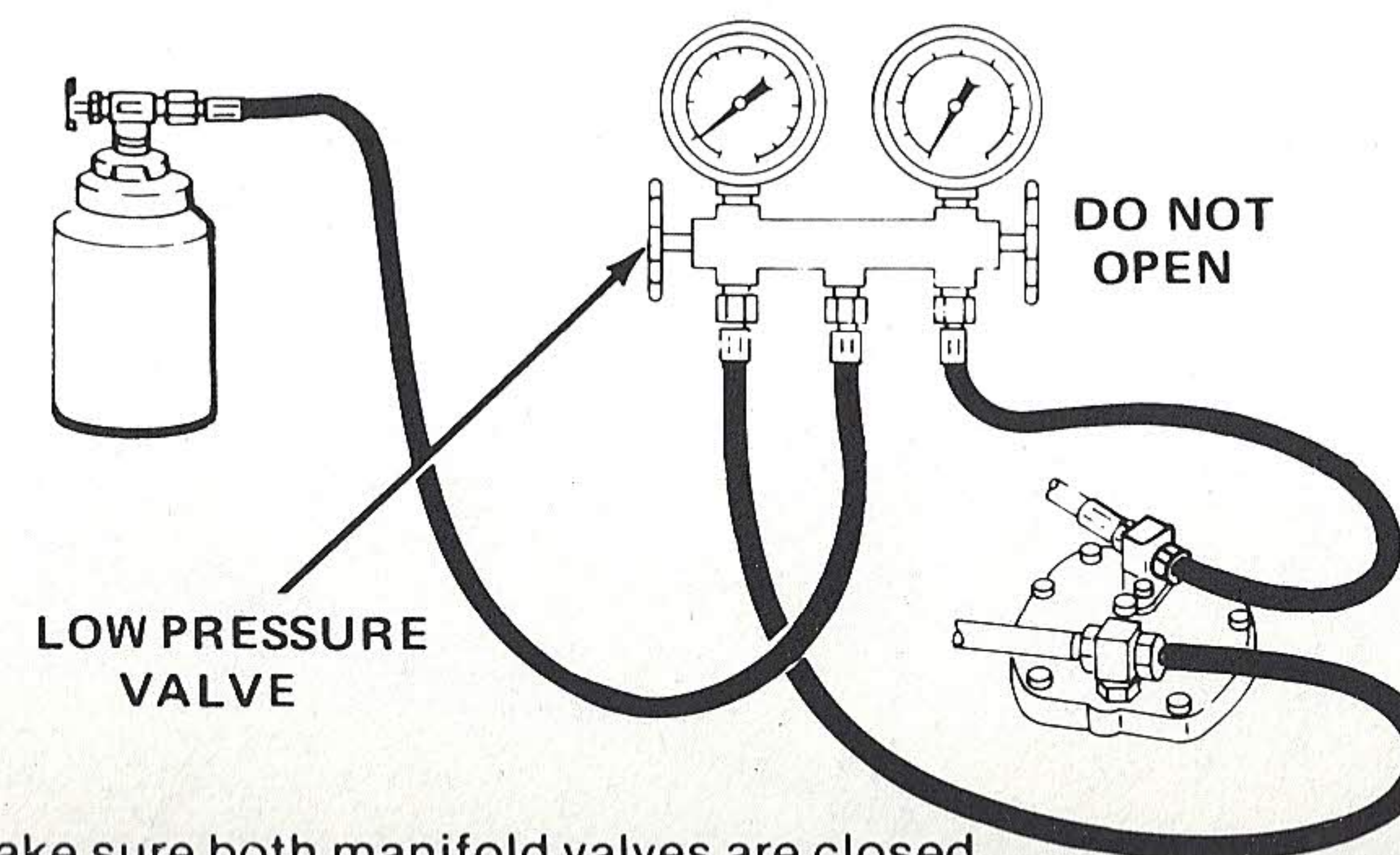

Make sure both manifold valves are closed.

Start engine. Adjust A/C controls for maximum cooling. Set blower switch to HIGH.

Open low pressure valve to allow refrigerant into system. DO NOT OPEN HIGH PRESSURE VALVE.

After low pressure gauge drops below 40 psi, momentarily invert can for faster charging. Repeat till can is empty.

CAUTION

Invert can only for a few seconds at a time. Holding can inverted will allow liquid into compressor. Excessive liquid could damage compressor.

CHARGING

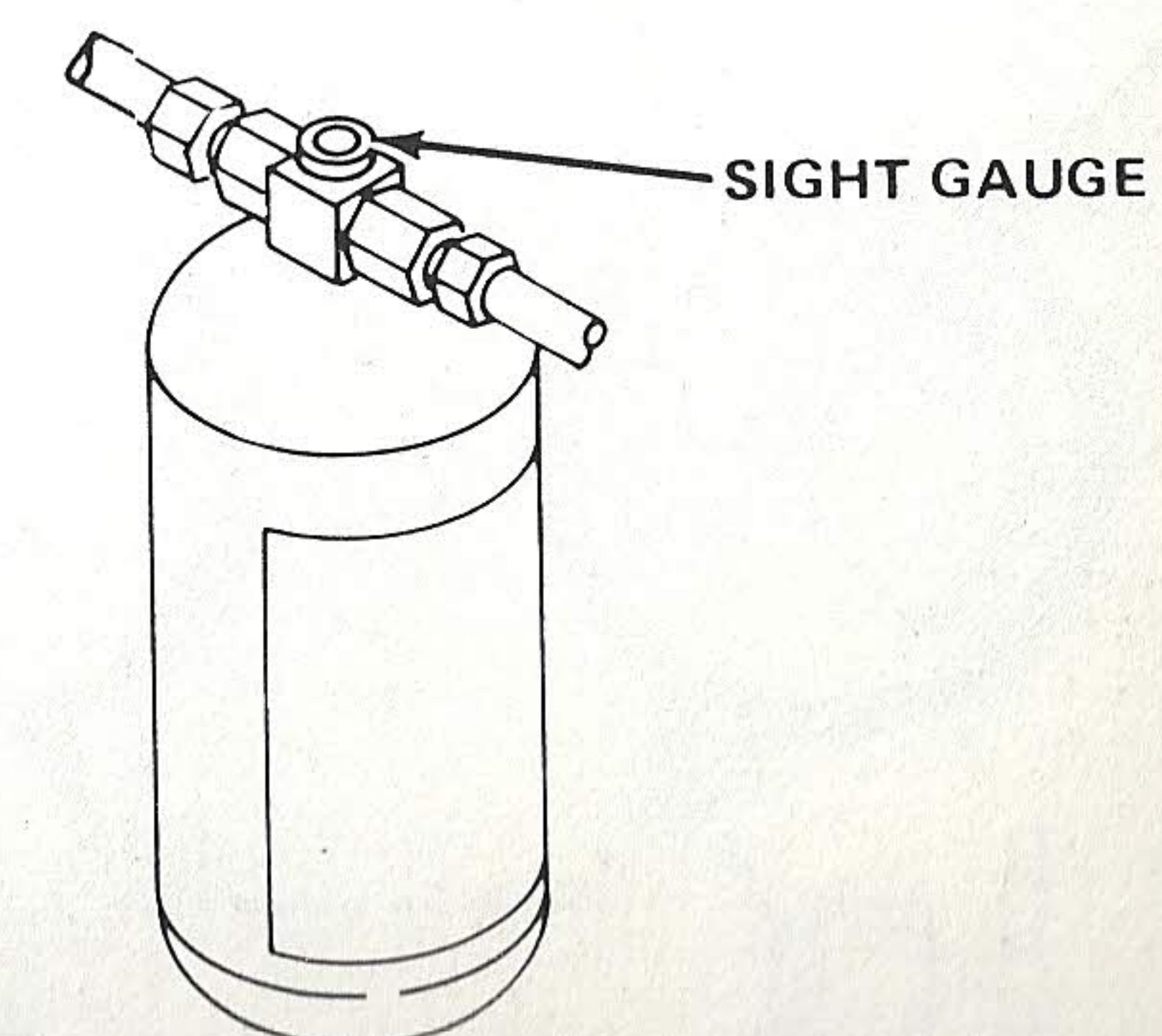

Repeat procedure with additional cans to charge system with a total of about 2½ pounds. Close low pressure valve before disconnecting cans.

Check sight gauge on receiver/drier to determine when system is completely charged. When refrigerant passing through sight gauge is free of bubbles, system is completely charged. Close low pressure valve. Disconnect yellow hose from can tap.

Check system operation.



Figure 1—Front LH Engine Compartment

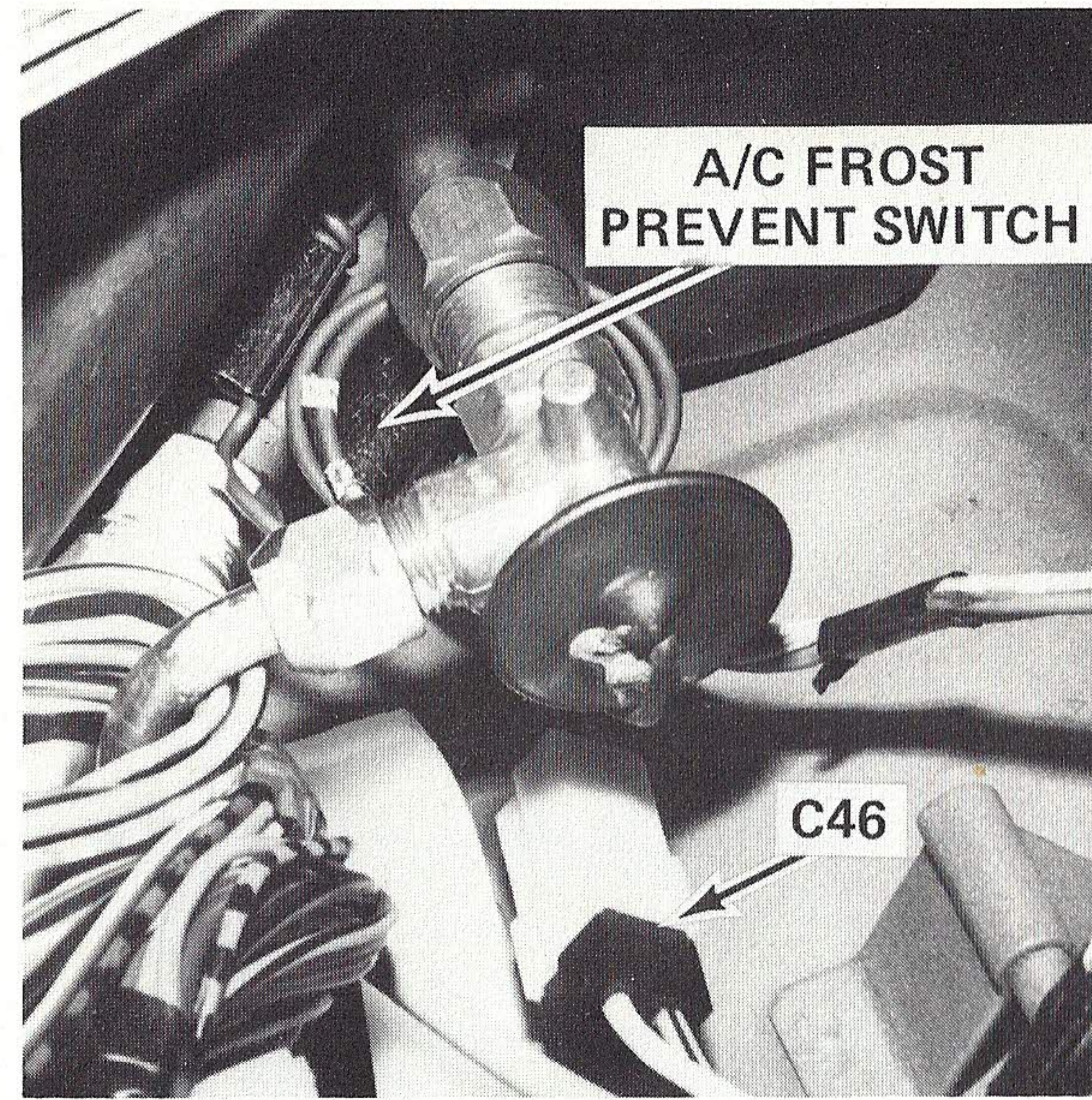

Figure 2—Passenger's Foot Well

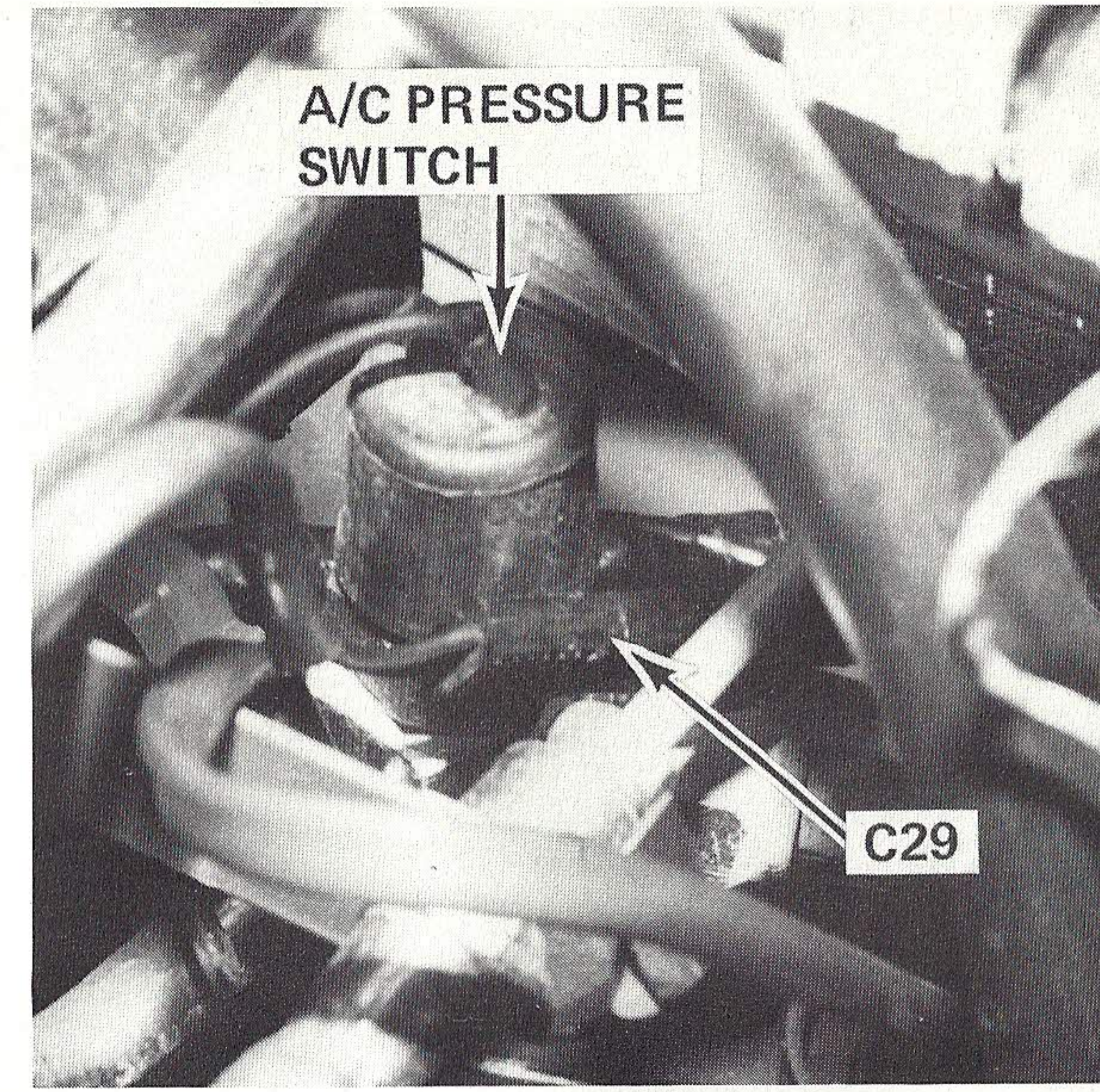

Figure 3—Front RH Engine Compartment

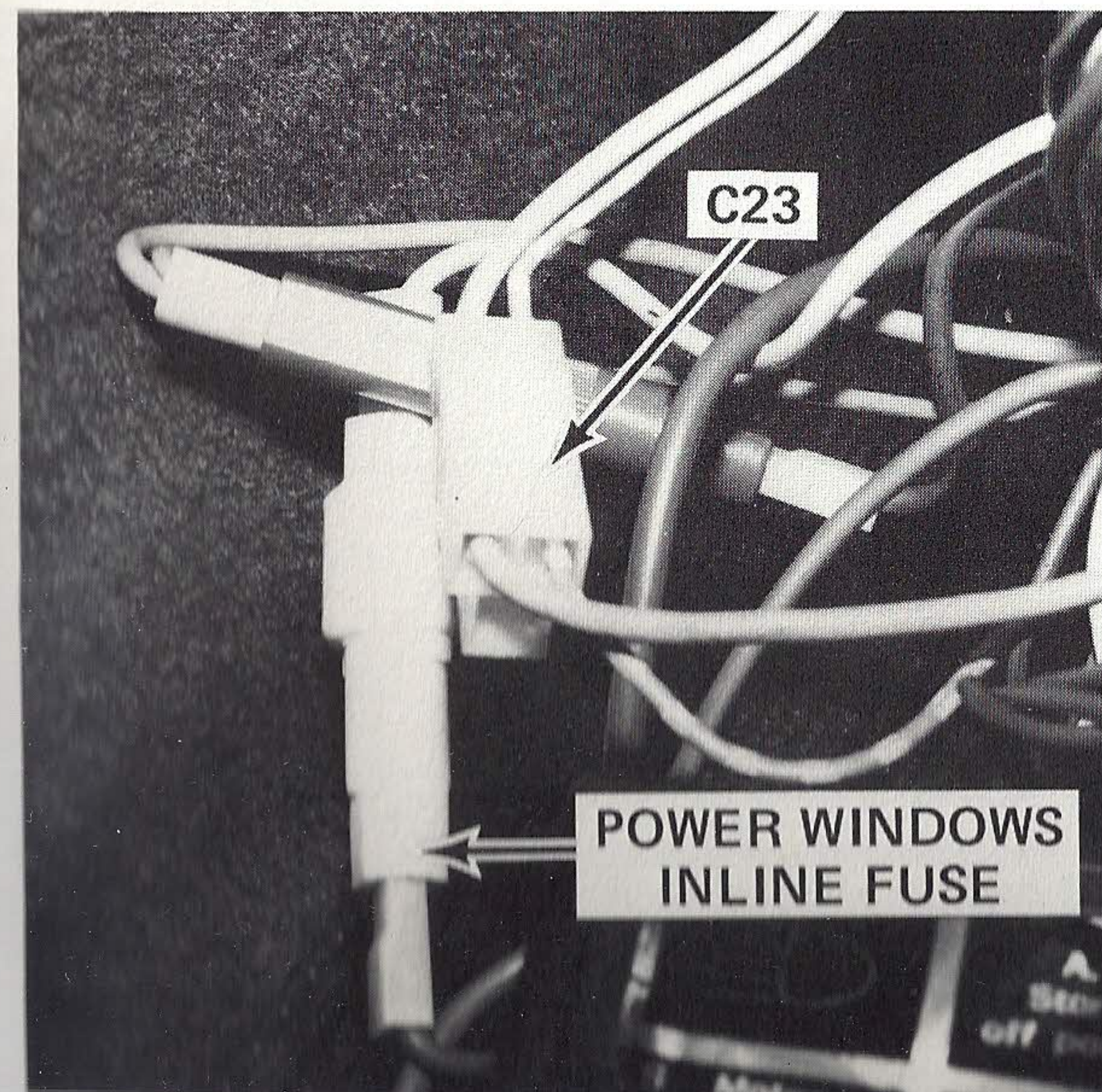

Figure 4—Beside Relay Panel

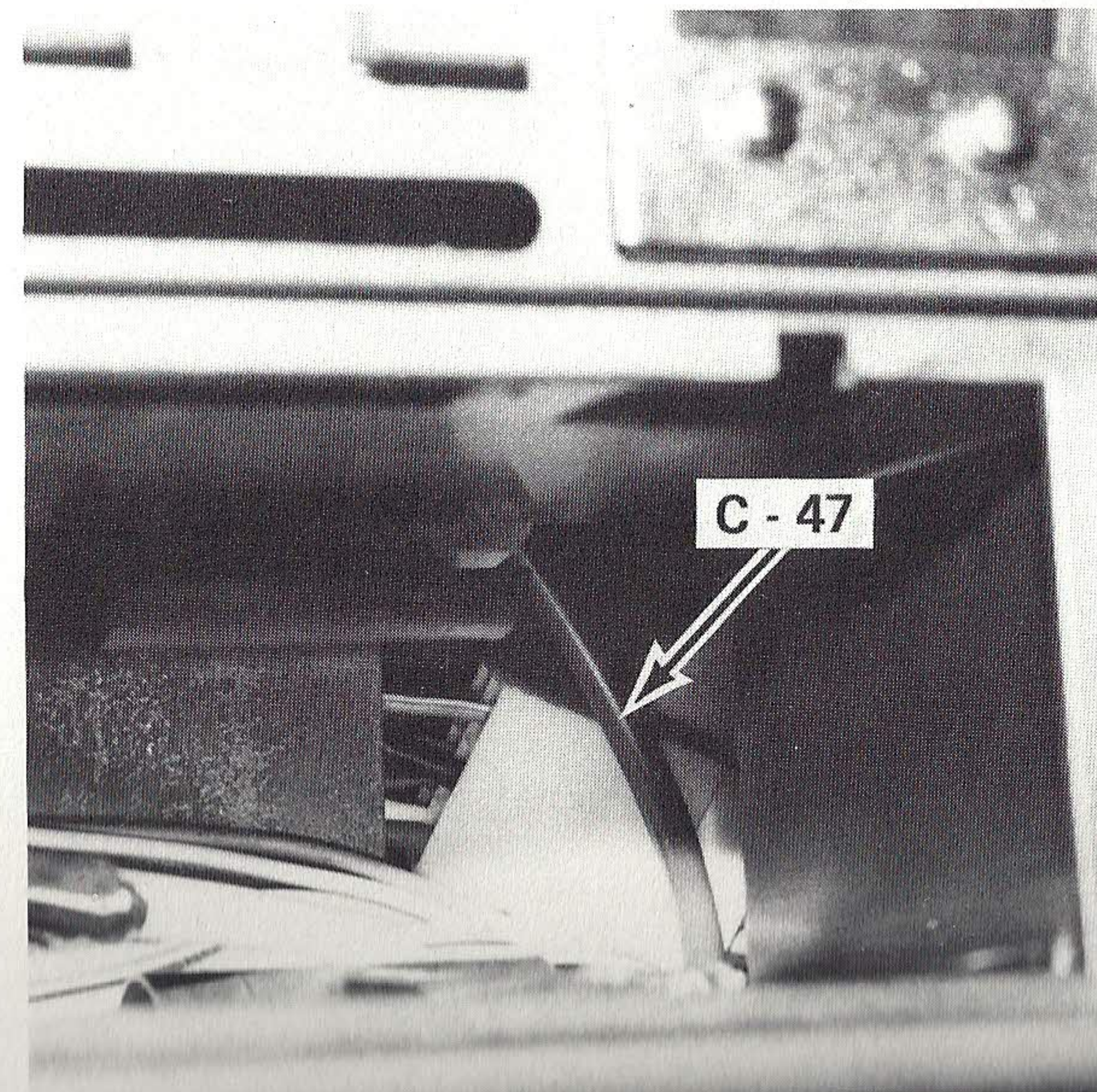

Figure 5—Behind Radio